

**Poli - poles Modelli - models**

<b>4</b>	<b>CS.80_ 25/30 . 4 . 152</b>
<b>2</b>	<b>CS.80_ 75/85/95/115 . 2 . 200</b>

**IT**

Elettropompa sommergibile di robusta costruzione fabbricata completamente in ghisa, con camera olio interposta tra gruppo motore e gruppo pompa e doppia tenuta meccanica: lato pompa posizionata sopra alla girante a diretto contatto del liquido pompato; tenuta meccanica lato motore interna alla camera olio.

**APPLICAZIONE:** l'elettropompa deve funzionare completamente immersa per garantire il raffreddamento da parte del liquido circostante. Sono idonee al pompaggio di acque piovane, o di falda con basso contenuto di solidi abrasivi (< 1 g/l), acque derivate da reflui civili e industriali.

**EN**

Robust construction submersible pump completely made in cast iron, with oil chamber interposed between motor unit and pump unit with double mechanical seal: the pump side one positioned above the impeller in direct contact with the pumped liquid; the motor side one, inside the oil chamber.

**APPLICATION:** the pump must be completely submerged to ensure the cooling by the pumped liquid. They are suitable to pump rain water or ground water with low quantity of abrasive solids (<1g / l), civil or industrial waste waters.

**FR**

Pompe submersible de construction solide entièrement en fonte, avec chambre d'huile interposée entre le bloc moteur et le groupe pompe et double garniture mécanique: le côté pompe placé au-dessus de la roue en contact direct avec le liquide pompé; garniture mécanique côté moteur à l'intérieur de la chambre à huile.

**APPLICATION:** la pompe doit être complètement immergée pour assurer le refroidissement du liquide pompé. Elles sont adaptées pour le pompage de l'eau de pluie ou des eaux souterraines avec de faibles particules abrasives (<1g/l), de l'eau provenant des eaux usées municipales et industrielles.

**ES**

Bomba sumergible de construcción sólida fabricada completamente de hierro fundido, con cámara de aceite interpuesta entre la unidad del motor y la unidad de la bomba y doble cierre mecánico: lado de la bomba colocado sobre el impulsor en contacto directo con el líquido bombeado; cierre mecánico en el lado del motor dentro de la cámara de aceite.

**APLICACION:** la bomba debe estar completamente sumergido para asegurar el enfriamiento del líquido bombeado. Son adecuadas para el bombeo de agua de lluvia o aguas subterráneas con bajo contenido de sólidos abrasivos (<1 g / l), el agua derivada de las aguas residuales municipales y industriales.



### IDENTIFICAZIONE - IDENTIFICATION

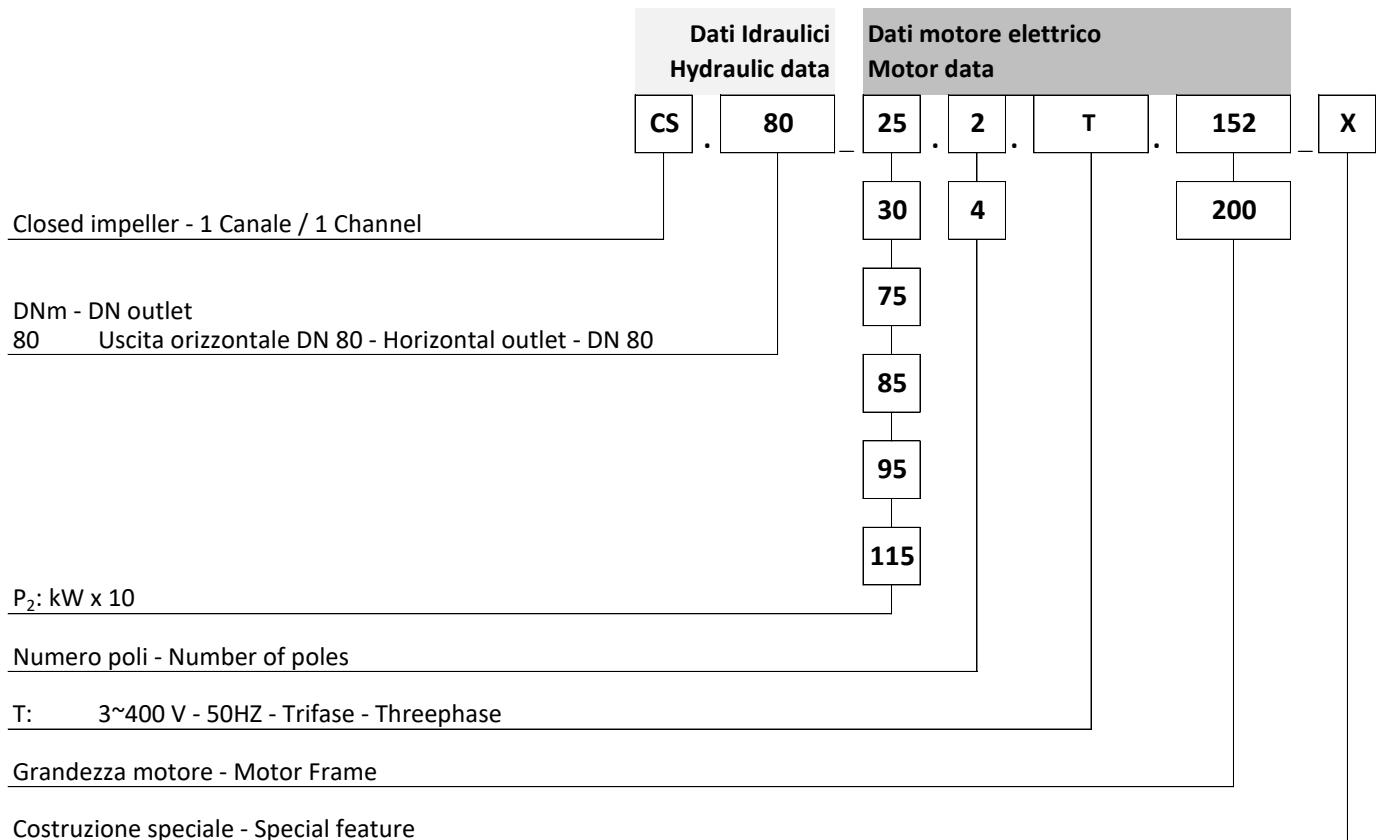

### LISTA MODELLI - RANGE OF PRODUCTS

Grandezza Motore Motor Frame	Poles	P <sub>2</sub> [kW]	Alimentazione Power supply	Modelli Models	Avviamento Starting	Cavo alimentazione / segnali Power / signals cable  [m] Type	Camera olio Oil Chamber
<b>152</b>	4	2,5	3ph	CS.80_25.4.T.152	D.O.L.	10    H07RN-F 7G1,5	SI YES
		3,0	3ph	CS.80_35.4.T.152	D.O.L.	10    H07RN-F 7G1,5	SI YES
<b>200</b>	2	7,5	3ph	CS.80_75.2.T.200	S.D.	10    H07RN-F 7G1,5 / 10G1,5	SI YES
		8,5	3ph	CS.80_85.2.T.200	S.D.	10    H07RN-F 7G1,5 / 10G1,5	
		9,5	3ph	CS.80_95.2.T.200	S.D.	10    H07RN-F 7G1,5 / 10G1,5	
		11,5	3ph	CS.80_115.2.T.200	S.D.	10    H07RN-F 7G1,5 / 10G1,5	

## Caratteristiche costruttive - construction features

**Motore asincrono** in classe di isolamento F (155°C), a secco e raffreddato dal liquido circostante;

**Asynchronous dry motor**, insulation class F(155°C), cooled by the surrounding liquid;

**Moteur asynchrone**, classe d'isolation F (155°C), sec et refroidi par le liquide environnant;

**Motor asíncrono**, aislamiento clase F (155 ° C), seco y refrigerado por el líquido que rodea.

### OPTIONAL

Sonda Olio  
Oil Probe  
Sonde d'huile  
Sonda de aceite

Girante chiusa  
monocanale  
Closed impeller  
single channel  
Roue fermée  
monocanal  
Impulsor cerrado  
monocanal

Anello d'usura  
Wear ring  
Bague d'usure  
Anillo de desgaste

Girante chiusa  
monocanale  
Closed impeller  
single channel

Roue fermée  
monocanal  
Impulsor cerrado  
monocanal

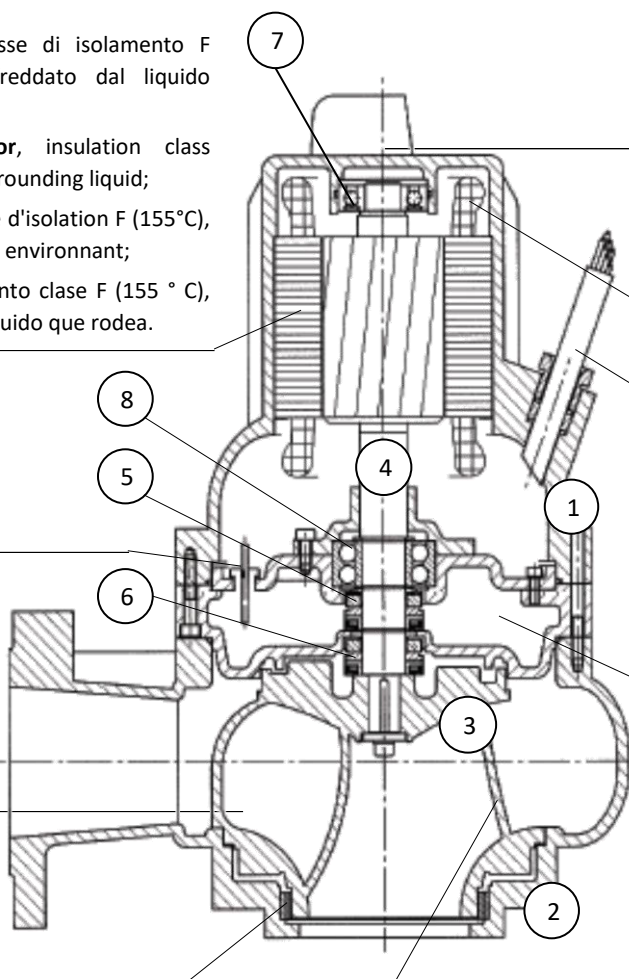

Anello per movimentazione pompa  
Shackel to handle the pump  
Manille pour lever la pompe  
Grillete para levantar la bomba

### OPTIONAL

Pastiglia termica  
Built in Thermal protector  
Protecteur thermique intégré  
Protector térmico incorporado

10 m - H07RN-F

Camera olio per il raffreddamento e la lubrificazione delle tenute meccaniche;  
**Oil chamber** for cooling and lubrication of mechanical seals;  
**Chambre d'huile** pour le refroidissement et la lubrification des **Cámara de aceite** para la refrigeración y la lubricación de los sellos mecánicos.

Viti Screws Vis Tornillos	Quality    A2
------------------------------------	---------------------------

O-RINGS	NBR
---------	-----

NR.	DESCRIPTION	MATERIAL
1	Gruppo motore	Ghisa
	Motor group	Cast iron
	Groupe moteur	Fer de fonte
	Unidad de motor	Hierro
2	Corpo idraulico	Ghisa
	Pump Housing	Cast iron
	Corps de la pompe	Fer de fonte
	Cuerpo hidráulico	Hierro
3	Girante	Ghisa
	Impeller	Cast iron
	Roue	Fer de fonte
	Impulsor	Hierro
4	Albero motore	Acciaio
	Shaft	Steel
	Arbre moteur	Acier
	Eje del motor	Acero

NR.	DESCRIPTION	MATERIAL
5	Tenuta mecc. superiore	Carbon graphite / Al-Oxide
	Upper mech. seal	
	Haut garniture mécan.	NBR
6	Tenuta mecc. Inferiore	SiC / SiC
	Lower mech. seal	
	Haut garniture mécan.	NBR
7	Sello mecánico superior	
	Cuscinetto superiore	
	Top bearing	6306-ZJ
	Roulement supérieur	
8	Cojinete superior	
	Cuscinetto inferiore	
	Lower bearing	3307
	Roulement inférieur	
	Cojinete inferior	



Tipo di pompa - Pump model

**CS.80\_152/200**Girante  
Impeller  
Mandata  
Discharge**1.CHANNEL****DN 80****Caratteristiche costruttive - construction data**

<b>Costruzione Motore - Motor Frame</b>	152 / 200	
<b>Grado di protezione IP - IP protection</b>	IP x8	
<b>Classe di Isolamento - Insulation Class</b>	F (155°C)	
<b>Tipo di servizio - Service type</b>	S1 Continuous / S3 Intermittent	
<b>Avvolgimento statore - Stator winding</b>	3~PH - Threephase	
	152	200
	Y / Δ	Δ / Y
	[V] 400 / 230	3~400/690
<input type="checkbox"/> <b>Protezione motore - Motor Protection</b>	Optional	Optional
<input type="radio"/> Bimetallico - Bimetal disc	<input checked="" type="checkbox"/> 130°C	<input checked="" type="checkbox"/> 130°C
<input type="radio"/> Solo su richiesta - on request only PT100	<input type="checkbox"/>	<input type="checkbox"/>
<input type="radio"/> Solo su richiesta - on request only PTC	<input type="checkbox"/>	<input type="checkbox"/>
<b>Raffreddamento - Cooling</b>	Dal liquido circostante - By surrounding fluid	
<b>Camera olio - Oil chamber</b>	Si - Yes	
<b>Protezione Tenuta - Leakage protection</b>	Optional	
<b>Tipo girante - Impeller</b>	CHIUSA MONOCANALE - CLOSED 1 CHANNEL	
<b>DN mandata - Discharge</b>	DN 80 PN16	
<b>Controflangia filettata - Threaded counterflange</b>	NO	
<b>DN aspirazione / Suction</b>	[mm]	Ø 80
<b>Tipo di vernice e spessore - Paint type and thickness</b>	Standard Vernice all'acqua - Water paint / 30µm Opaco Nero - Opaque Black	

**Limiti di utilizzo - Operating Limits**

<b>Temperatura massima liquido - Pumped fluid max temperature</b>	[°C]	< 40
<b>Densità liquido - Density</b>	[Kg/dm <sup>3</sup> ]	~ 1
<b>Viscosità - Viscosity</b>	[mm <sup>2</sup> /s]	~ 1
<b>Contenuto di cloruri - Chlorides content</b>	[mg/l]	< 200
<b>PH liquido pompato - PH value</b>		6 ÷ 12
<b>Max. prof. Immersione - Max. Immersion depth</b>	[m]	20
<b>Max. contenuto solidi abrasivi - Max. abrasive solid content</b>	[g/l]	< 0,1

**CURVA CARATTERISTICA - PERFORMANCE CURVE**

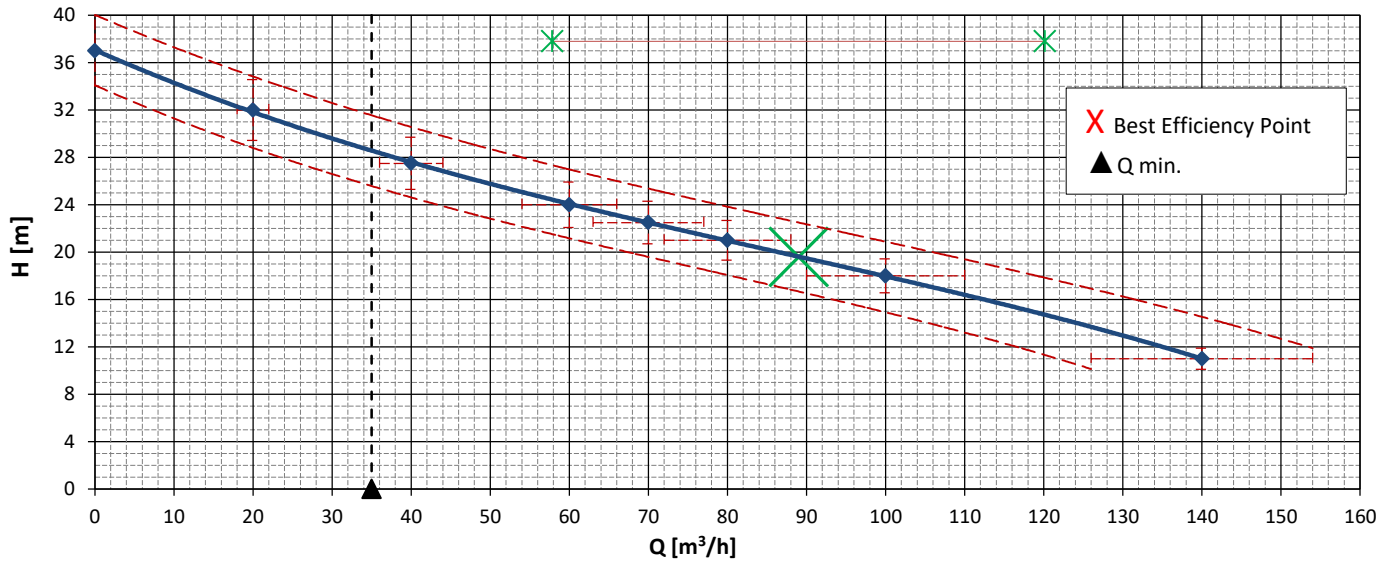

**POTENZA ALL'ALBERO - SHAFT POWER**

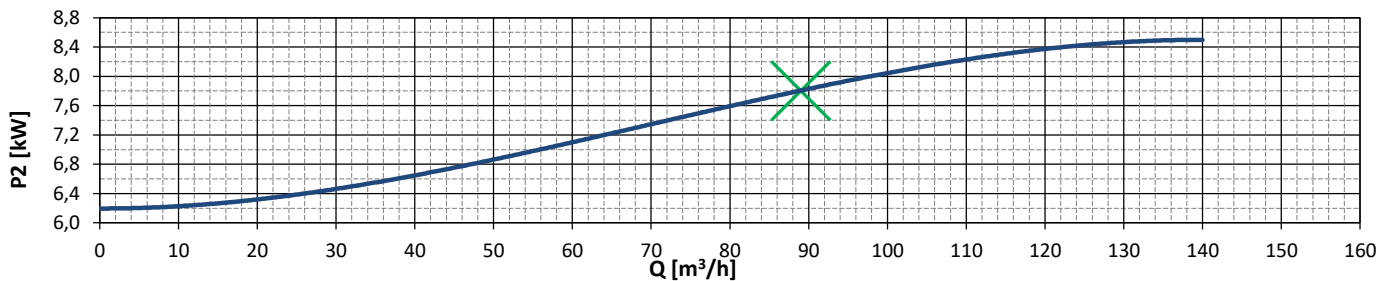

**RENDIMENTO IDRAULICO - HYDRAULIC EFFICIENCY**

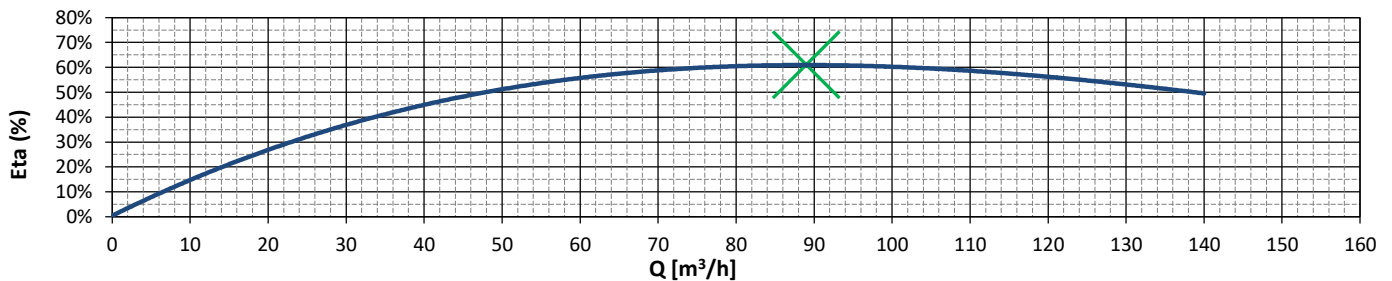

FLOW (Q)	l/min	0,0	333,3	666,7	1000,0	1166,7	1333,3	1666,7	2333,3				
	l/s	0,0	5,6	11,1	16,7	19,4	22,2	27,8	38,9				
	m³/h	0,0	20,0	40,0	60,0	70,0	80,0	100,0	140,0				
HEAD (H)	m	37,0	32,0	27,5	24,0	22,5	21,0	18,0	11,0				

**Dati pompa / Pump data**

Potenza nominale Nominal power	(P <sub>n</sub> )	[KW]	<b>8,5</b>
Potenza all'albero Shaft power	(P <sub>2</sub> )	[KW]	<b>8,5</b>
Potenza assorbita Supply Power	(P <sub>1</sub> )	[KW]	<b>10,5</b>
Fattore di potenza Power Factor	Cosφ		<b>0,87</b>

**Model T**

Alimentazione Power supply	[V]	<b>3~400-50Hz</b>
Avviamento Starting		<b>D.O.L. - S/D</b>
Corrente Nominale Rated current	[A]	<b>17,4</b>
Corrente di spunto Starting current	[A]	<b>116 - 67</b>

Passaggio libero Free Passage	[mm]	<b>Ø 56</b>
Diametro girante Impeller diameter	[mm]	-
Peso pompa Weight	[Kg]	<b>116,0</b>

Galleggiante Float level switch		<b>No</b>
Cavo Cable		<b>10G1,5</b>
Nr. Avviamenti / ora Nr. Start per hour		<b>15</b>

In accordo con: ISO 9906:2012 - Grade 3B ( section 4.4.2)  
In accordance to:

Curve per liquidi con densità/curve established for liquid with density  
1Kg/dm<sup>3</sup> - viscosità/viscosity 1 mm<sup>2</sup>/s - temperatura/temperature 20°C

### Dimensioni d'ingombro - overall dimensions

**S** Installazione mobile - Installation mobile - Installation mobile - Instalación móvil

CS.80.75.2T.200 - CS.80.85.2T.200 - CS.80.95.2T.200 - CS.80.115.2T.200

Dimensione imballo Packaging dimensions		
A	B	C
750	450	390

Misure - Measures [mm]		
A	B	C
750	450	390

**FC** Con piede di accoppiamento - With foot coupling - Avec pied d'assise - Con pie de acoplamiento

CS.80.75.2T.200 - CS.80.85.2T.200 - CS.80.95.2T.200 - CS.80.115.2T.200







<b>8FC00004</b>	<b>KG: 30</b>
-----------------	---------------

1	Supporto tubi guida da 1 <sup>1/2</sup> 1 <sup>1/2</sup> guide rails bracket
2	Piede uscita verticale 3" Vertical foot - 3"out
3	Slitta completa Sliding bracket complete
4	Esclusi dalla fornitura Not supplied

D	550
E	600
F	400





**ACCESSORI - ACCESSORIES - ACCESORIES - ACCESORIOS**

Descrizione - Description - Description - Descripción		Codice Code
FC	 <ul style="list-style-type: none"> <li>- Dispositivo di accoppiamento DN 80 - uscita G 3"</li> <li>- DN 80 Coupling device - outlet 3"</li> <li>- Dispositif de couplage DN 80- sortie G 3"</li> <li>- Dispositivo de acoplamiento DN 80 - salida G3"</li> </ul>	8FC000004
STD	 <ul style="list-style-type: none"> <li>- Cavalletto di sostegno in acciaio inox</li> <li>- Stainless steel support stand</li> <li>- Support en acier inoxydable</li> <li>- Soporte de acero inoxidable.</li> </ul>	8FC000010
AT80	 <ul style="list-style-type: none"> <li>- Adattatore per dispositivo di accoppiamento della concorrenza</li> <li>- Adapter for competitors foot coupling devices</li> <li>- Adaptateur pour pied d'assise du concurrent</li> <li>- Adaptador para dispositivo de acoplamiento de competidor</li> </ul>	2SB000004
	 <ul style="list-style-type: none"> <li>- Catena ferro zincato - galvanized Iron - fer galvanisé - hierro galvanizado</li> <li>- Chain</li> <li>- Chaîne</li> <li>- Cadena Acciaio - Stainless steel - acier inox -acero inox</li> </ul>	2SC000019 2SC000032
FBV	 <ul style="list-style-type: none"> <li>- Valvola di ritegno a palla Flangiata</li> <li>- Flanged valve</li> <li>- Vanne à bride</li> <li>- Válvula de brida</li> </ul>	DN 80 PN10 4BV000007
HF	 <ul style="list-style-type: none"> <li>- Regolatore di livello per acque reflue</li> <li>- Level switch for sewage</li> <li>- Interrupteur de niveau pour eaux usées</li> <li>- Interruptor de nivel para aguas residuales</li> </ul>	[10 mt] 3CS000007
SHELL	 <ul style="list-style-type: none"> <li>- Contrappeso SHELL per galleggiante</li> <li>- Counterweight SHELL for level switch</li> <li>- Cotrepoids SHELL pour interrupteur de niveau</li> <li>- Contrapeso para interruptor de nivel</li> </ul>	3CS000021

**SELEZIONE QUADRO DI CONTROLLO - CONTROL PANEL SELECTION**

	Pole	Pump	P <sub>2</sub> [KW]	In [A]	Avv.
152	4	CS.80_25.4T.173	2,5	5,8	DOL
		CS.80_30.4T.173	3,0	6,2	DOL
200	2	CS.80_75.2T.200	7,5	15,2	DOL
		CS.80_75.2T.200.SD			S/D
		CS.80_85.2T.200	8,5	17,3	DOL
		CS.80_85.2T.200.SD			S/D
		CS.80_95.2T.200	9,5	19,0	DOL
		CS.80_95.2T.200.SD			S/D
CS.80_115.2T.200.SD	11,5	23,0	S/D		

 - ECH - ELECTROMECHANICAL									
1 PUMP					2 PUMPS				
ECH1.T-7 5EC000005	ECH1.T-22 5EC000009	ECH1.T.S/D_20 5EC000106	ECH1.T.S/D_28 5EC000013	ECH2.T-7 5EC000029	ECH21.T-22 5EC000033	ECH2.T.S/D_20 5EC000108	ECH2.T.S/D_28 5EC000037		
•				•					
•				•					
	•				•				
		•				•			
	•				•				
		•				•			
			•				•		

 - ECL - ELECTRONIC			
1 PUMP		2 PUMPS	
5EC000083	5EC000086	5EC000084	5EC000087
•		•	
•		•	
	•		•
		•	
	•		•
		•	
	•		•
		•	