

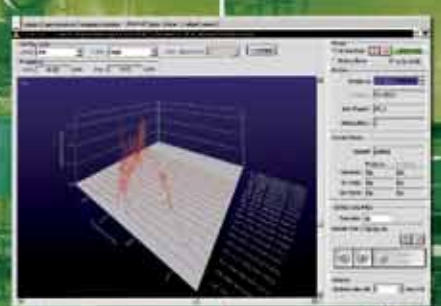

# InduSoft<sup>®</sup>

## InduSoft Web Studio Energizes Oil & Gas

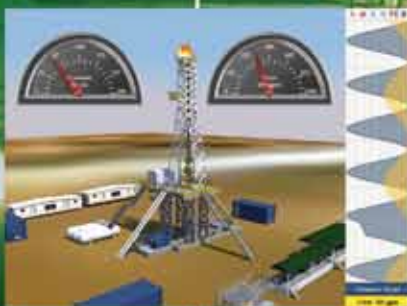



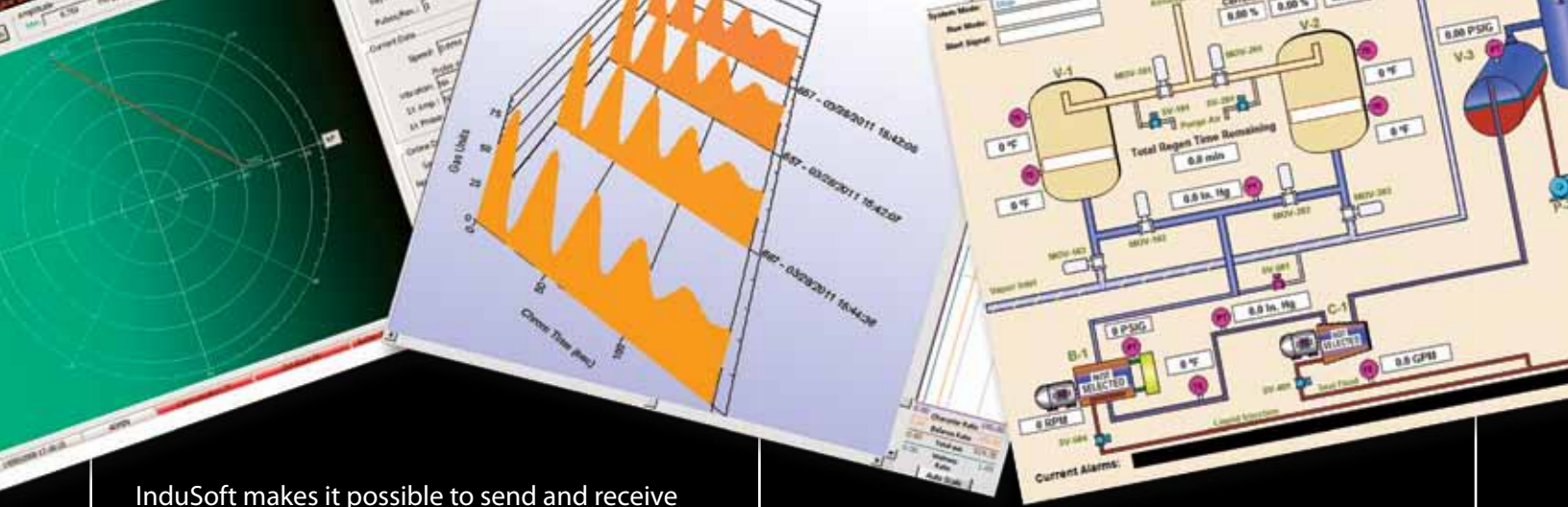

InduSoft makes it possible to send and receive data from multiple systems by taking advantage of the more than 240 communication drivers built-in to InduSoft Web Studio. With these native communication drivers, and full OPC connectivity, it's possible to communicate with PLCs and controllers from nearly any manufacturer.

InduSoft also has patented database connectivity, making it incredibly easy to connect to multiple data sources, both to record information, and to use process data to develop analytic dashboards that allow operators to read information at a glance, and make quick decisions that improve safety, productivity, and efficiency.

## Remote Site Control – Send Information Anywhere, and Act Immediately

As systems grow less isolated and begin to take advantage of internet and cloud based capabilities, the ongoing need to mobilize oil and gas data is driving many operators to seek SCADA solutions that provide mobile and remote monitoring capabilities. InduSoft Web Studio makes viewing remote data easy, and provides many options for viewing and controlling a remote site, or for communicating with multiple sites from a central control room. Now, it's possible to interact with your application anywhere you go, on a tablet or smartphone.

### Thin Clients

InduSoft offers three different types of thin clients for remote applications

#### **Secure Viewer**

InduSoft's Secure Viewer Client operates as an alternative to browser-based thin clients, and

offers a safe, stable client for a remote SCADA or HMI application. The Secure Viewer is supported by machines with a Windows operating system, and enables users to see a full graphical representation of their application, interact with screens, and take advantage of InduSoft Web Studio security features using a dedicated client. Smartphones and Tablets utilizing iOS or Android operating systems can also access applications by acting as a virtual machine for a PC with InduSoft Web Studio installed.

#### **Web Thin Client**

The InduSoft Web Studio web thin client can be accessed on any device that uses Internet Explorer, including Windows-based tablets and smartphones. The web thin client offers full graphic representation of your application, the ability to view and interact with screens remotely, and the security of user and group level protection of data.

#### **Studio Mobile Access (SMA) Client**

InduSoft offers two versions of the SMA client, which allows you to truly take your data anywhere you go. Studio Mobile Access Tabular allows you to view process data, acknowledge alarms, and even comment on those alarms. Studio Mobile Access (enhanced in InduSoft Web Studio v7.1), also includes these functions, but also allows users to create intuitive widget dashboards that provide information at a glance. Studio Mobile Access is based on HTML5, and can be used on any device with an internet browser. This includes the iPad, iPhone, and Android smartphones and tablets. With the SMA client, it's possible to acknowledge alarms wherever you are, and make the necessary comments required for safety and traceability standards.

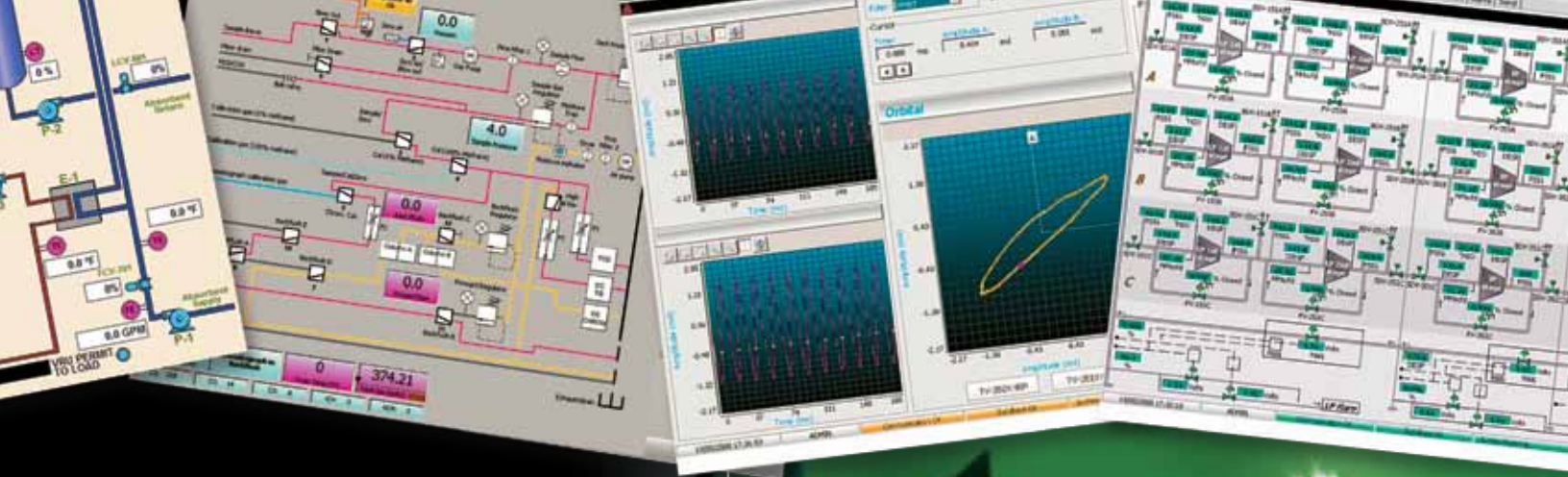

## Safety and Regulatory Standards

Safety and security are challenges that must be addressed for oil and gas engineers. Not only must machines and equipment be monitored regularly for safety, but the data produced must be secured. InduSoft has made it a long-term goal to provide stable SCADA software with the tools to ensure that any process can be conducted safely, and in line with regulatory standards required around the world.

Data security through InduSoft is provided with a variety of tools. InduSoft Web Studio's security features offer the ability to create user and group levels of authorization with username and password protection. Authorization levels for process control can be restricted only to authorized users or groups, and systems can record actions taken by logged-in users. This allows managers to ensure that only authorized personnel have access to critical process functions, and that all user activity is logged for records. In addition, InduSoft Web Studio can record recipe and batch information, as well as users who initiated a batch process or created or changed a recipe. Audits can be easily conducted using this information, and user data can also be stored to meet regulatory traceability standards. Intellectual property can also be protected by ensuring that only authorized users have access to data.

The safety of machines and personnel can also be secured using InduSoft Web Studio. Alarms can alert operators to potential problem zones, and preventative maintenance reminders can be built-in to the application. When machines can tell operators when they need servicing or inspecting, it's easy to ensure that safety codes are being met and maintained. Not only will this prevent downtime, but will also help protect against operator safety hazards.







## Learn More About InduSoft in Oil and Gas

InduSoft has developed several case studies in coordination with customers who have used InduSoft Web Studio in oil and gas applications. You can read the case studies at [www.indusoft.com](http://www.indusoft.com), or email InduSoft or your local InduSoft distributor for more information on oil and gas applications that have utilized InduSoft Web Studio in well, drilling, and pipeline SCADA systems. InduSoft also has an oil and gas demo application available, allowing you to see for yourself how SCADA software can be used to improve the efficiency, productivity, and safety of your system.

For more information, contact us at **877-INDUSOFT** or **512-349-0334** or email us at [info@indusoft.com](mailto:info@indusoft.com)

©2013 InduSoft, Inc. All rights reserved worldwide.

For more information, contact:

**MET** الموارد للهندسة والتجارة ش.م.م.  
Almawared Engineering and Trading  
2, Ahmed Taysser St., Heliopolis - Cairo - Egypt  
Tel. : +202 24192480 Fax : +202 24192483  
e-mail : [almawared@link.net](mailto:almawared@link.net)



When it comes to  
packaging, think  
outside the box.

— *Web-Ready*

**InduSoft**<sup>®</sup>

Realize Your Potential





# ADVANTAGES IN EVERY PHASE OF PACKAGING

From OEE tools to modular solutions, InduSoft Web Studio provides easy-to-use tools turning data into high yield production. No matter what form your packaging process takes, InduSoft Web Studio has the tools and the flexibility to monitor, track, and improve your packaging line. Save time in development, reduce errors in production, and pack and ship more product by leveraging the extensive tools available in this fully featured SCADA/HMI development suite.

InduSoft Web Studio can be scaled for every step of your operation, from the smallest touch-screen HMI to fully visualized dashboards available in the board room, or on the go via smartphone. Every step of the process, from monitoring fill and buffer capacity to maintaining machines can be performed using this powerful SCADA/HMI solution.

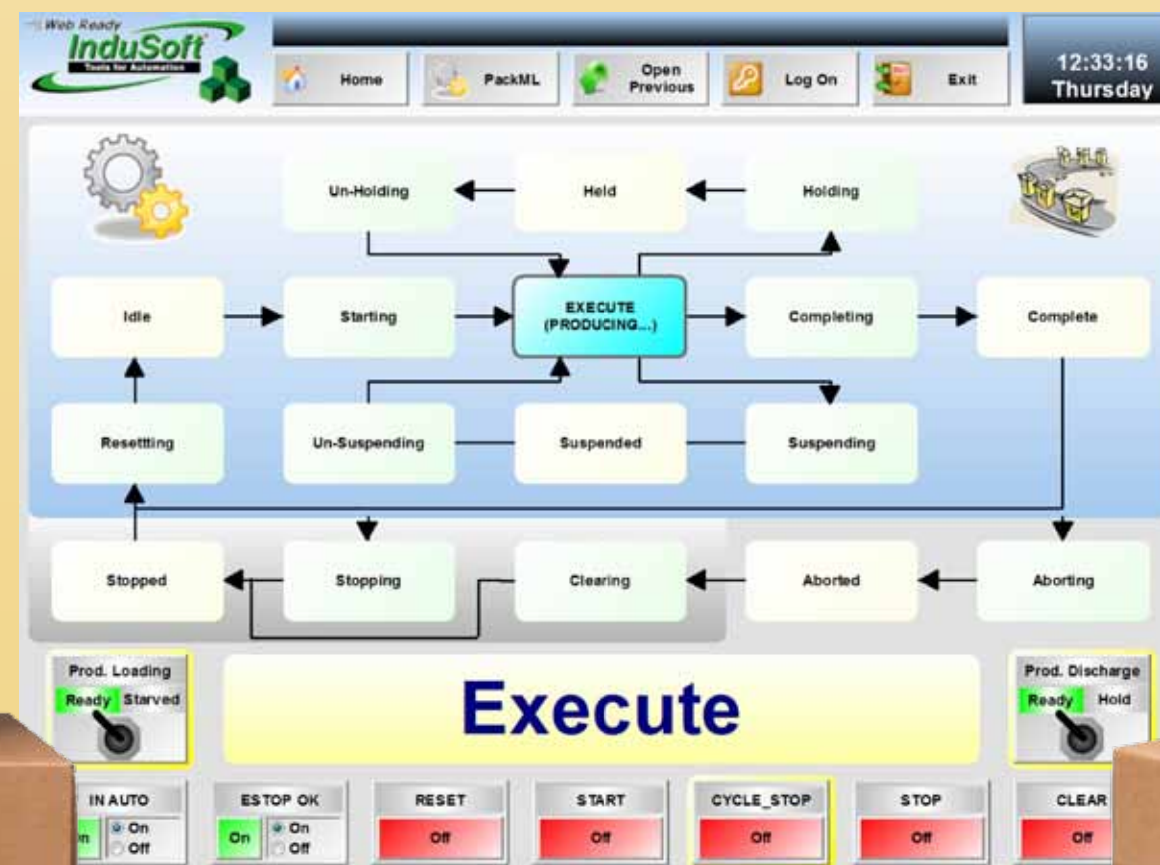

# BENEFITS FOR EVERY PACKAGING MACHINE

InduSoft Web Studio has tools available for a variety of specific processes in the packaging industry. Whether you're filling blister packs that require you to be FDA 21 CFR Part 11 compliant, or you need an OEE dashboard solution to monitor your entire line, you have all the tools you need at your disposal.

**1. Feeding:** Stand alone or multi-lane feeders can be fine tuned using InduSoft Web Studio. Adjust vibration frequencies, directions, lane adjustments and feed rates. Animation provides the visual feedback operators need. Even on small 4-6" displays, position, rotation and animation allow operators to be more efficient and make setup changes reliably. **Product changeover time is reduced using built-in recipe functionality.** Portable feeders can even be moved from machine to machine with drastically reduced setup time.

**2. Blister Packaging and Vacuum:** Monitor pressures, temperatures, relative humidity, operator behavior and any other traceability parameters. **InduSoft Web Studio can create applications that are FDA 21 CFR Part 11 compliant.** Heat zones can be monitored. Use recipes to instantly set up new product changeover. Create custom reports with times and date stamped lot information.

**3. Capping:** Whether your capping process is manual, automatic or semi automatic, InduSoft Web Studio can help make your process more efficient. **Create graphs to identify quality issues before products ship to customers.** Easily enter parameters for gripper width, belt height, location setup, cap feeder levels, and sorter setup.

**4. Conveyor and Material Handling:** Create modular, yet customizable conveyor architectures. Display information directly from drives and automated controls systems. **Share status information with machine PLC and other controllers without the need for expensive gateway hardware.** Provide status remotely. Alarms and other parameters are sent to remote stations, or even mobile phones. Real time information is presented in a user friendly display.

**5. Forming, Filling, and Seal:** Change bag length, rate, seal time, weight, and gas dispensing parameters. Simultaneously display data from PLC, checkweigher and inspection equipment, including metal detectors, and vision systems. Why force the operator to look at many different displays? Simplify your design by coordinating product changeover. Use handshaking and communication with upstream equipment to ensure bags are not filled with the wrong product. **Track change over in any SQL database for future inspection.**

**6. Inspecting:** With over 240 built-in drivers and the ability to use OPC servers, InduSoft Web Studio can communicate with nearly any inspection equipment. Eliminate costly specialized interfaces. Metal detection tunnels, vision systems, and even x-ray systems can be combined on one simple interface. Alarms are issued visually, audibly, and remotely. Take the guesswork out of your operation. Log inspection results directly to any external relational database. Save alarm history and event history to any SQL Relational Database, without the addition of any

add-on package. **InduSoft has a patent for exchanging data with remote SQL Relational Databases, even from Windows CE devices.** It is not necessary to write scripts for the most commonly used database integration. The interface contains built-in history tasks (Alarm, Trends, and Events), as well as in-graphic objects such as Trends, Alarms, Grids, and Combo-boxes. InduSoft Web Studio allows you to customize any SQL command, including the executing of store procedures..

**7. Case and Tray:** Case/tray forming, gluing, folding, lidding, wrapping and strapping operations demand reliable monitoring and information. **Give the operator the information they need to keep the machine running smoothly.**

**8. Accumulating:** Monitor status upstream and downstream. InduSoft Web Studio can communicate with most PLCs, dedicated controllers, or databases. When you need to prevent critical machine stoppages, use InduSoft Web Studio to share the information between disparate devices. By logging and trending your buffer size, tuning your accumulator couldn't be easier. Prevent blocked or starved situations and keep your line running smoothly. **Share information upstream and downstream directly to other HMI workstations, by using the built in TCP/IP communication interface without tying up valuable PLC resources**

**9. Cartoning:** Share information between feeder, guarding, and safety systems, drives, lubrication systems, all on one screen. Have a long or large machine? No problem! **Use InduSoft's web thin client to deploy low-cost workstations at multiple key locations around the machine. Keep the operator more efficient, reduce downtime, and make more products.**

**10. Labeling:** Integrate with barcode, 2D and even RFID tag printers. Coordinate the printing and scanning all in one device. InduSoft works with most scanners, via USB, keyboard wedge, or dedicated devices. Do you manufacture printer technology? Embed an InduSoft Web Studio application right in your printer. Provide your customers with great looking displays and set up pages on an Internet Explorer web browser. Coordinate directly with MES systems and download data right from plant floor systems. **No longer write custom code for each customer. Easily integrate with production systems and existing back office environments.**

**11. Wrapping:** Shrink wrap tunnels to pallet wrapping; let InduSoft scale to meet your machinery needs. **Run InduSoft Web Studio software on devices as small as a few inches to large flat panel displays.**

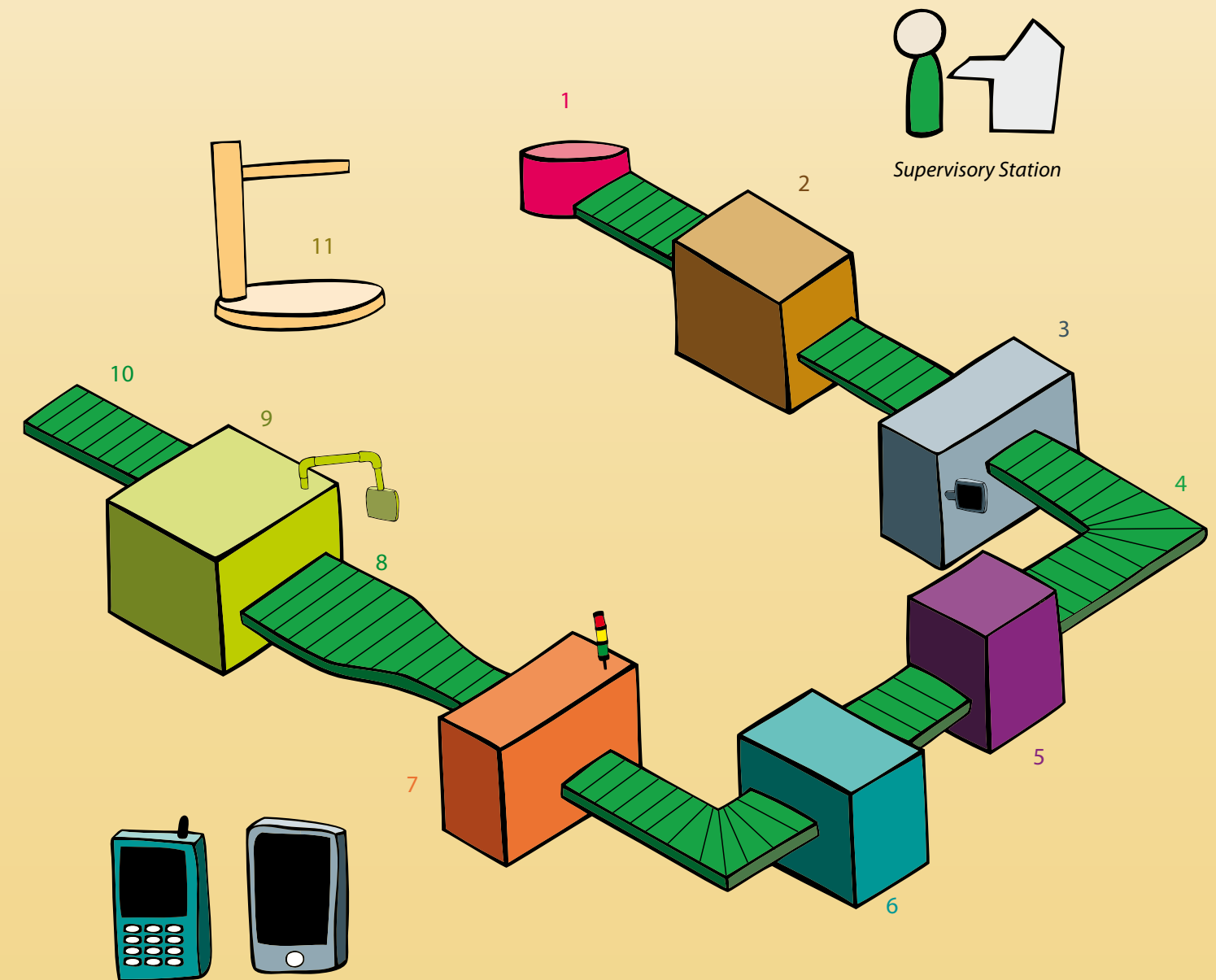

You can also deploy on your cell phone!



# FLEXIBILITY AND FUNCTIONALITY WITH INDUSOFT WEB STUDIO

## **Clipboard Extinction, Log Data Anywhere:**

Exchange data with any external SQL Relational Databases, via third-party ODBC, OLE-DB, ADO, or ADO.NET providers without the addition of any additional package. Automate the collection of data. Don't use your valuable human resources to record information and type it into Excel. Easily connect to ANY SQL or Oracle database, Excel, Access, ERP, SAP, or MES system. Automate collection of real-time data for Key Performance Indicators (KPI) such as Overall Equipment Effectiveness (OEE), downtime, and others. Is the logging of critical data a must? Built-in store and forward functionality logs information locally when the network is down, and synchronizes with the server when the network is restored. All of this happens without human interaction.

## **Save Time with InduSoft Symbols:**

InduSoft offers an extensive library of symbols installed along with the product. In addition to the graphic design, the symbols include built-in animations, allowing for color changes, bar graphs, rotation, and more. Animate these simply by linking project tags to the pre-built symbols. Customize native symbols, or create your own, and share them with many different projects. InduSoft Web Studio also provides the ability to modify a master symbol and replicate the changes to all instances of this symbol throughout the entire application. It represents huge time savings when deploying, maintaining, or enhancing real-world projects. InduSoft Web Studio also utilizes enhanced graphic interfaces such as 3D buttons, the ability to link icons to buttons, and the capability to apply dynamic rotation to bitmaps during the runtime.

You can also use external symbol libraries with the InduSoft HMI/SCADA package. Since InduSoft is an Active/X and .NET container, you can simply drop these 3rd party graphics onto the screen. InduSoft Web Studio provides the flexibility to use built-in graphics or external graphics packages in order to create a dynamic and intuitive application.

InduSoft Web Studio also allows you to customize faceplates as Linked Symbols. Using the built-in "Import Wizard", import complete templates, with tags, screens, scripts, and even driver configuration.

## **Easy to Use Development Environment :**

The ribbon interface has a modern look and feel, and brings increased user-friendliness and productivity. The new interface also offers the ability to open more than one document tab simultaneously, which speeds design workflow. Create consistent user interfaces, or share custom color pallets to keep corporate color standards throughout your project

## **Native Languages Means Less Mistakes:**

If you build machines that ship globally, or are used in areas that are known to be multilingual, take advantage of InduSoft's easy configuration for language. The software supports Unicode, allowing translation to Arabic, Chinese, Russian, and other non-Latin character sets. In fact, InduSoft Web Studio translates all texts configured in the application with the click of one button using the Auto Translate tool. After translating all texts from the project automatically (via an internet-based API), you have the ability edit any text, such as technical terms or acronyms.

Since InduSoft Web Studio translates entire phrases rather than each word individually, the grammar rules for each language are automatically taken into consideration when translating the project. The runtime language can be selected during the runtime and each thin client can select a language individually. In addition to language translation, InduSoft Web Studio allows you to adjust other settings to localize your project, such as date format and engineering units.

## **Quickly Choose Tagnames or I/O Points:**

InduSoft Web Studio provides a built-in tag browser and built-in function browser. As you type the tag name, the browser automatically filters the tags that match the typed name providing efficiency, even in large projects. The VBScript interface supports "intelliSense", so there is no need to open a different pop-up dialog to browse the tags or functions.



## **Reduce Machine Maintenance and Downtime:**

InduSoft Web Studio provides a complete set of "remote management tools" to deploy, troubleshoot, enhance, and maintain applications through any TCP/IP link. Monitor tags, write values to tags, monitor the application events such as the Protocol Analyzer, and implement changes on the application remotely with a web-based configuration. The new, customizable installer allows the creation of install disks that contain only the features you want, plus your application, making it easier to deploy machine after machine with consistency. Quickly change PLC suppliers. Create efficient setup screens. Store parameters independent from machine logic, saving valuable PLC memory costs. All of these things enable you to produce higher quality machines more quickly.

## **Choice of Communications and an Open Architecture:**

InduSoft Web Studio provides built-in drivers for most PLCs, drives, temperature controllers, scales, and inspection devices. Over 240 drivers included for Ethernet, serial or hardware based protocols. Drivers for Allen Bradley, Modbus (Schneider), GE, Mitsubishi, Omron, Siemens, and many others are included in the SCADA software suite. Use any PLC you want or the one your customer demands.

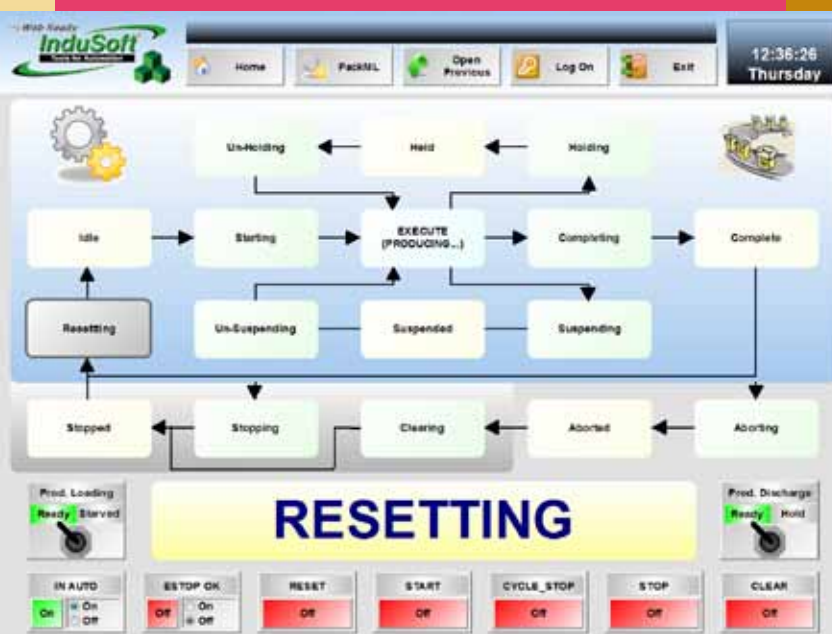



With support of several different protocols, platforms, databases, or systems, you're never locked into a proprietary software/hardware solution. InduSoft Web Studio provides interfaces based on standard technologies (OPC DA/XML/UA/.NET), ActiveX, .NET Controls, ODBC, OLE-DB, ADO, Gateways to third-party SCADA, and readily available APIs for integration with third-party proprietary systems. Write scripts within the package using a non-proprietary language such as VBScript.

InduSoft supports all currently supported Microsoft operating systems, including Windows Embedded, Windows CE, Windows XP, Windows Vista, Windows 7, Windows Server, Windows 2003 Server, and Windows 2008 Server R2 (32 and 64 bits).

**Stress Free, 100% Compatibility:**

InduSoft makes it a mission to maintain compatibility with applications created in any previous version of our software. This protects your investment when designing symbols, templates, or entire applications. Keep different versions of the development environment simultaneously installed on the same computer, under different directories. Applications developed in 1997 have been loaded into current versions and work without modification. Find that anywhere else!

**Remote Web and Mobile Solutions Gain Efficiency:**

Visualize your application from remote web browsers using Internet Explorer with user logon based permissions. The same screens developed for the local user are available for the "remote" user on the Web Thin Client station. Use the Secure Viewer thin client to run remote stations

without any additional configuration on the Server station. Design screens that can be visualized from mobile devices such as PDAs or cell phones powered with a Microsoft operating system such as Windows Mobile or Windows 7, or use the Studio Mobile Access (SMA) client to receive information on iPads, iPhones, Android tablets, Blackberries, or any other web enabled device.

**Maintenance Ease:**

Eliminate costly service calls. Make informed decisions in real-time. Understand what it takes to keep machinery running. Monitor, diagnose, and interact with your applications remotely through built-in web interface. Display repair videos showing exactly what needs to be done, reducing or eliminating downtime.

**Enhanced Security System:**

The enhanced security features offer you the capability to share the security system settings among several stations, integrate the application with the Microsoft Active Directory, create a security system via LDAP, or cache security system authentication information.

**Protect Your Corporate Property:**

InduSoft Web Studio provides security for intellectual property. Each document in the application can be protected by password.

**Bar Code and RFID Scanning Solutions:**

Eliminate costly PLC add-on modules, connect scanners directly to the HMI. Increase reliability by reducing data entry errors, "fat-finger" mistakes and confusion. Easily tie this data directly to SQL databases for traceability or verification.

**Reduce Product Changeover Time:**

Your customers demand shorter batch changeover. Use built-in recipe functionality to quickly change machine parameters with little or no operator interaction. Verify critical changes on a remote desktop PC or on mobile phones (including iPhones, and smart phones). Modify the application during the runtime using the online configuration. It is not necessary to shutdown the application to implement changes.

**Reduce Hardware Costs, Dual Monitor Functionality:**

Display the graphic interface in two monitors connected to the same computer (CPU). The graphic interface available on each monitor must provide independent screen navigation. This architecture does not have to rely on duplication of any screen during the development of the application. Large or long machines can simultaneously display information on remote monitors and interact with touch screens or other user input devices. Save cost by deploying robust remote monitors rather than full industrial PCs.

**Visual Understanding:**

Because a picture is worth a 1000 words, trends can visually alert you much quicker than raw data. Fill the area below the pens, apply transparency, and add pictures and text. Statistical Process Control (SPC) is included. Simply enable it with the click of an icon. No programming necessary. Easily view average, Min/Max, and standard deviation effortlessly.

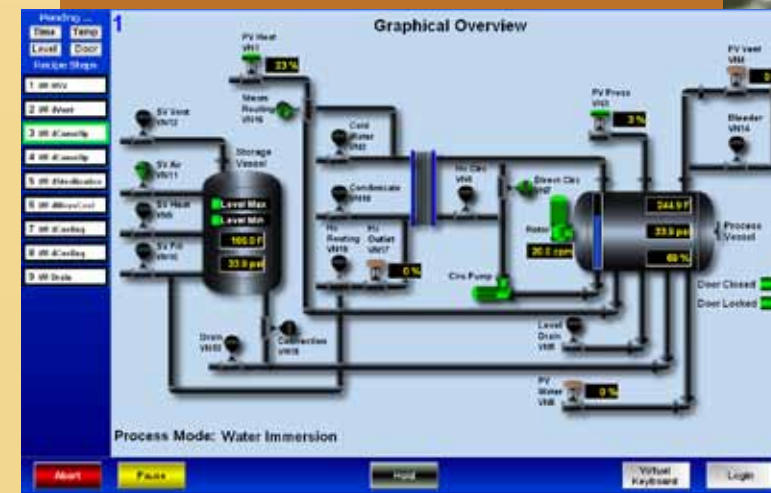



09/07/2011

13:53:18



Corrugated Paper

Open Previous



Operation Mode

Auto Stop

Auto Selected Preparing Fold

Reset Production: 1

Pneumatic Commands

Y14A		Y14B		Y14C		Y14D	
←	→	←	→	←	→	←	→
BE14A_B	BE14A_F	BE14B_B	BE14B_F	BE14C_F	BE14C_B	BE14D_F	BE14D_B
○	○	○	○	○	○	○	○

M11A 100.000%

M11B 100.000%

M13 20.000%

M13 - Speed

*From OEE tools to modular solutions, Indusoft web studio provides easy-to-use tools turning data into high yield production.*



About InduSoft



Main Features



Demo Applications





090911-BR-PAC-A-ENLT-PT

© 2011 InduSoft, Inc. All rights reserved worldwide.

InduSoft is a trademark of InduSoft, Inc. and Microsoft, Windows are either registered trademarks, or trademarks of Microsoft Corporation in the United States, and/or other countries. All other trademarks are the property of their respective owners.

**indusoft.com**  
**info@indusoft.com**

# InduSoft Web Studio

## Turning Renewable Energy into a Revolution!



### What Makes InduSoft Web Studio Ideal for Renewable Energy Applications?

- Scalability:** From low-cost embedded RTU applications to server scale SCADA implementations, InduSoft Web Studio provides all of the necessary tools in a single development environment.
- Flexibility:** InduSoft Web Studio provides the most interoperability of any HMI/SCADA solution on the market. With over 240 communication drivers for all major PLCs, RTUs, and controllers, as well as OPC support (UA, HDA, DA, and Xi), InduSoft Web Studio makes it easy to communicate with a variety of hardware and software components.
- Security:** InduSoft Web Studio v7.0 offers new security features, like support for Microsoft Active Directory. A stable and secure SCADA system is vital for the remote monitoring schemes commonly used in renewable energy applications.



### Wind Energy

**From “Small Wind” to “Wind Farm”, InduSoft Web Studio can handle it!**

- InduSoft Web Studio is ideal both as an embedded product found at the individual wind turbine level, or as a complex SCADA application monitoring performance of entire wind farms
- Remote Monitoring capabilities allow users to keep abreast of key system parameters using web-based thin clients, smart phones, e-mail alerts, and more.
- Connect to external weather resources like remote gust sensors to position turbines for optimal performance.
- Reduce downtime by monitoring critical performance metrics (such as shaft vibration or brake wear) and employing predictive maintenance practices.

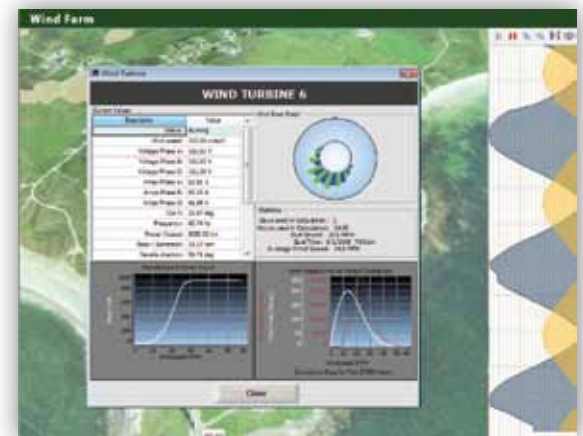



# InduSoft Web Studio

## Turning Renewable Energy into a Revolution!

### Solar Energy

#### Soak in the sun with InduSoft!

- Use InduSoft Web Studio to enable remote monitoring, troubleshooting and performance tracking of your solar farms over Ethernet, radio modems, or even a satellite connection.
- Use InduSoft Web Studio to interface with controllers on solar tracking systems and maximize energy output from your solar arrays.
- Use built-in Overall Equipment Effectiveness tools to provide insight into asset utilization and system degradation.
- InduSoft Web Studio can be configured to provide instant local access to product manuals and maintenance schedules/procedures.



### Energy Consumption

#### Measuring energy consumption is the first step in "Going Green"

- Use InduSoft Web Studio to interface with many types of equipment and accurately record the consumption of electricity, gas, steam, water, and other resources.
- Databases/reports help facility management better understand historical usage and plan for energy optimization and reduction efforts.
- Use visual dashboards as a teaching tool so that building occupants are aware of current consumption patterns (or cost savings)



**Microsoft** Partner  
Gold Independent Software Vendor (ISV)

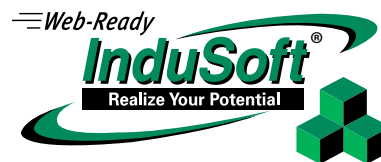

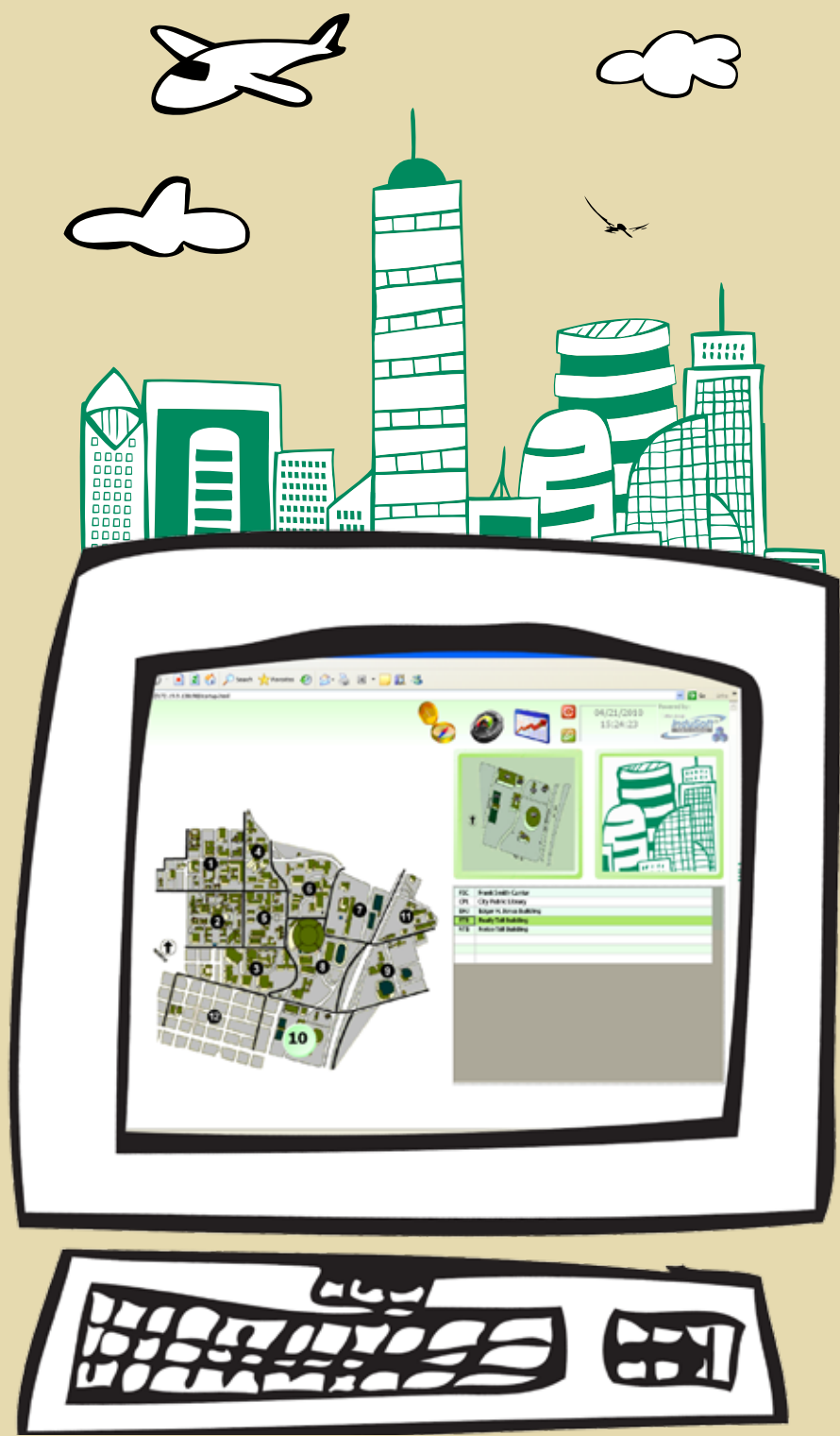

**Energy Management and Building Automation**

**InduSoft®**



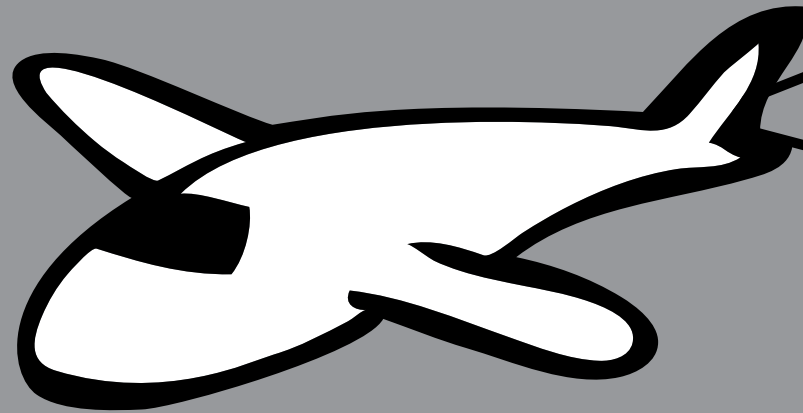
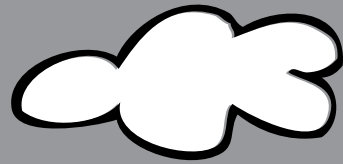
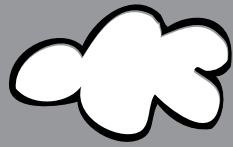

## Building Automation Solutions with InduSoft Web Studio

As energy costs rise, new infrastructure projects are undertaken, and older buildings are retrofitted to new standards, the building automation industry increasingly turns to SCADA solutions to keep pace with technology.

InduSoft Web Studio has proven through countless applications designed for building automation that it packs in all the tools and functions necessary to monitor and control everything from schools across whole districts, hospitals, pharmaceutical warehouses, and even personal homes. InduSoft Web Studio is non-proprietary, and can communicate with devices from nearly every vendor using the over 240 built in native drivers (Including BACnet and Modbus). The software also supports OPC DA, OPC UA, and OPC .NET 3.0 connectivity.



# Trends In Building Automation

## *Rising Energy Costs are Changing the Way We Build*

With the increase in energy costs and the corresponding need to reduce energy consumption, the demand for buildings to speak to us and to tell us how best to maintain them has never been greater. Facilities are becoming increasingly connected to utilities, and interest in renewable energy options continues to rise. This has forced companies to have to evaluate what equipment they have on their facilities, what the real costs behind operating that equipment may be, and what changes can be made in the operation to curb energy use and make the most efficient systems.

In addition, there is a growing global shift toward buildings that have a lower carbon footprint, or buildings that can even become carbon neutral. Accomplishing this requires a careful collection of data that can be used to quantify energy use and expenditures.

## *A Demand for More Control*

Scheduling, is a function that no good building automation system can be complete without. To accomplish the goals of using energy efficiently, scheduling tools have become increasingly critical. InduSoft Web Studio includes the scheduling tools necessary to reduce energy use during off-peak hours, night, or even account for variables in scheduling such as holidays or events.

## *Increased Security Concerns*

Addressing the increasing complexity of security management of these systems in real time is a growing challenge. InduSoft Web Studio provides tools that allow connections to barcode and RFID chip readers, enabling door badge systems and other methods of user authentication. The software also supports user accounts and varied levels of user access, which makes it possible to track doors and security systems, and even the traffic of personnel that comes in and out of the facility.

## *A Fully Integrated Solution*

InduSoft Web Studio is being used to relay important information about energy management, optimized operating conditions, and improved asset utilization. All too often people think of building systems as just heating, ventilation and air conditioning (HVAC) systems, but a truly integrated system covers much more. Integrated Systems have the ability—with a single interface—to be able to manage, monitor and operate all aspects of the building including heating and air conditioning, security and surveillance, lighting, fire and safety systems, as well as other building equipment.

## *A Push Toward Cloud-Based Connectivity*

InduSoft has long provided the functionality to configure web-based applications, and applications that can send alarms and other data directly to e-mail or via SMS. Smartphones are increasingly popular ways to visualize data. InduSoft Web Studio provides three different types of thin client options that will allow users to create building automation systems that can be viewed or managed not only in a central control room, but from every corner of the facility.

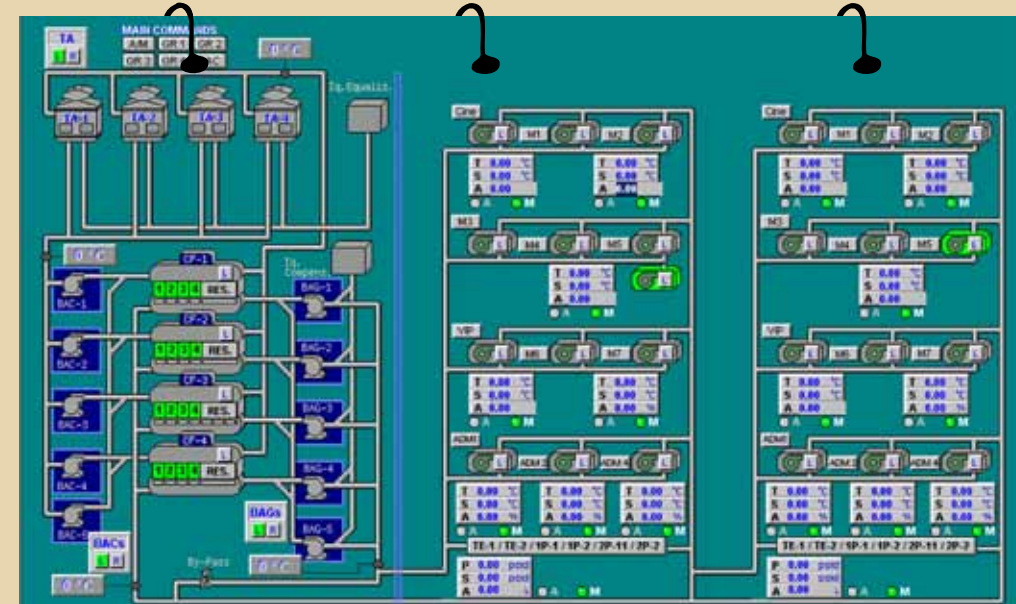



## An Easy Solution for a Complex System

The need for simple tools for automation that allow you to deploy highly redundant control systems to mobile devices has never been greater. These control systems also provide the flexibility required for a master plan for building automation that involves a whole building approach for energy efficiency, and to comply with government regulations.

The InduSoft Web Studio commitments for interoperability with such systems as lighting controls, HVAC mechanical equipment, security and access control systems, fire and life safety systems, and many other kinds of systems are the basis for a long-time support of the BACnet and Modbus protocols.

InduSoft Web Studio has drivers for BACnet and Modbus that will allow a user on any Microsoft Platform from Windows Embedded to Windows 7 to connect to lighting, HVAC, security, and other systems and devices from multiple vendors that can be attached to a network. This capability enables single-seat, global control, and access to all connected building control systems.

For logging and retrieving data, InduSoft has developed a patented method of connecting with any SQL database that goes a long way in making the acquisition and retrieval of this data a very simplified process. The purpose of our software is not that you be a programmer or have extensive familiarity with databases – we provide you with a platform that makes it easy to acquire the data, and then visualize and interpret it through the system.

As building automation continues to evolve, it must constantly work with legacy systems that are not typically replaced every five or fewer years. For example, a building's chillers often perform for 30 years. InduSoft Web Studio understands the need to constantly work with legacy systems while evolving to newer technologies. InduSoft Web Studio maintains this balance by providing seamless integration with new releases of its product. An application written in InduSoft Web Studio V1.0 can be upgraded to the latest release InduSoft Web Studio v7.0 without changes. It is completely compatible, providing users with new technology while still maintaining compatibility with legacy systems.

With the evolution of Wireless Control Networks for Building Automation, InduSoft Web Studio is poised with its strong mobile offering to provide flexibility for building managers to virtually connect to any building system using a mobile or wireless device such as cell phones or tablet computers. Integrating controls saves on cost, as operators are better able to view equipment performance and be more proactively involved in preventative maintenance. With the ability to reduce energy consumption,

InduSoft Web Studio helps to position buildings to go completely green. With regulations evolving in this area, being proactive in creating a single interface that allows viewing from mobile devices, the Web and a control interface will provide an unprecedented level of real-time monitoring and control of heating and air conditioning, security and surveillance, lighting, fire and safety systems as well as other building equipment.

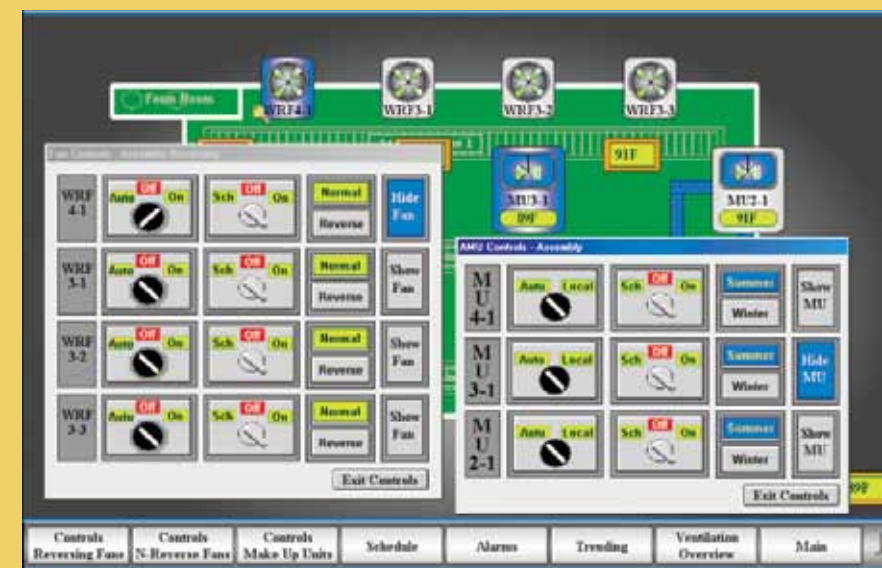
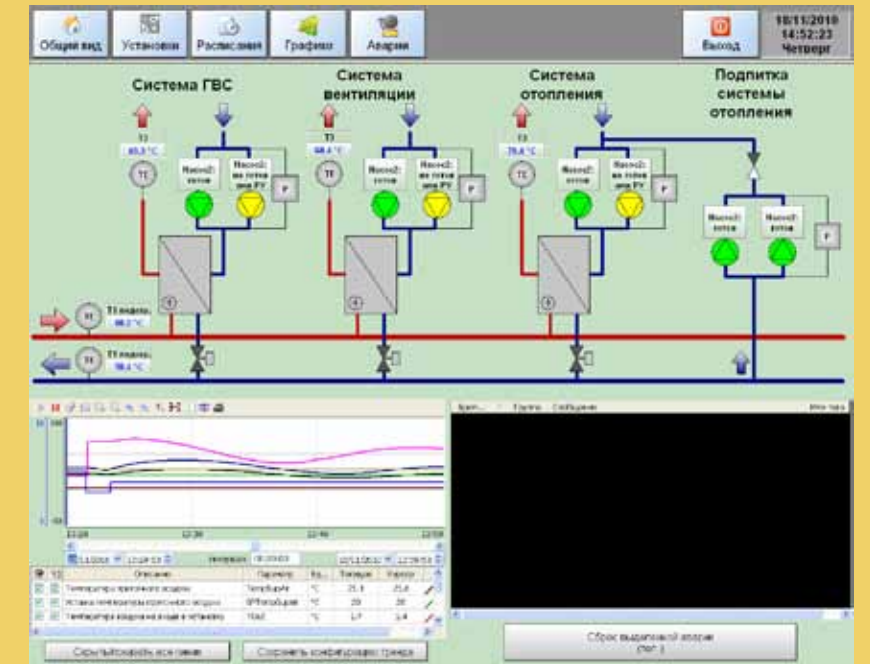

## Case Studies in Building Automation with InduSoft Web Studio

InduSoft Web Studio has been used worldwide for building automation projects ranging from single family homes to entire school districts. We encourage you to read the full case studies online at [www.InduSoft.com](http://www.InduSoft.com), or request printed versions from your local InduSoft representative. Here is a brief overview of some of the applications InduSoft Web Studio has been used to create:

### **Retel Neuhausen AG Helps Merck & Cie Meeting New, Tight Standards:**

Retel Neuhausen AG was charged with developing an application that would help a Merck and Cie plant meet tight government regulations. Under internationally sanctioned guidelines, not only must process data be recorded, but environmental conditions of rooms and storage and production facilities must be monitored as well. In addition, security is required that will allow record-keeping of user access to equipment and materials. This requires traceability features, such as individual user access with protected usernames and passwords, and the verification of eSignatures. InduSoft Web Studio was used to develop an application that met all international regulations related to the environmental quality of this pharmaceutical production facility.

### **A Building Management System for Hospitals in Russia:**

The Central Clinical Hospital of the Federal Custom Service, located in Moscow, contracted with the Russian company First Mile to develop a building management system that would meet all the requirements of a state-of-the-art medical facility. First Mile created a building management system for them using InduSoft Web Studio for a powerful medical facility automation application. First Mile constructed an application with a minimal number of screens by using key technology and VBScripting native to InduSoft Web Studio. The finished product monitors each of the engineering functions, and collects information on the ventilation system, the air chiller and HVAC, the temperature, and air supply. The issue of the hot water supply was also a major aspect of the design of the system. The water, distributed by the largest supplier in Moscow, Monsenergo, required quick changes in temperature and pressure.

### **Paulista Shopping Mall:**

The upscale Paulista shopping mall in São Paulo, Brazil uses an intuitive building automation interface to control all phases of operation using InduSoft Web Studio. The graphic displays allow ease of use that allows for reduced operator training costs, and slow network speeds have been overcome thanks to communication optimization by InduSoft. This application could be designed easily and efficiently thanks to the tools included for quick development and rapid deployment.

### **Dosapac S.A. using technology to set the bar in school building automation systems:**

Over 75% of the schools in Portugal's secondary public school network are facilities that were built before 1968. Parque Escolar was established in Portugal as a government backed corporation tasked with modernizing Portuguese school buildings. Along with new fixtures and flooring came new challenges, such as how to automate vital functions. Everything from energy supplies and consumption to the climate control needed to be monitored in order to protect the quality of the environment for students and faculty.

Using InduSoft, Dosapac S.A. was able to create a new standard for building management software for buildings in Portugal. By contributing to Parque Escolar, they are able to help create state of the art school buildings throughout Europe.

### **American Water Heater:**

Most of us take hot running water for granted and give no thought whatsoever to what life might be like without it. American Water Heater Company is one of the leaders in the contingent that makes that simple luxury a reality. Using the drag and-drop paradigm, American Water Heater designed an application to monitor and control the ventilation system in their plant in weeks rather than months. Manufacturing engineers successfully coupled the ventilation system to 17 temperature systems throughout the plant. Within a few months, more than 100 different control points will also be monitored, enabling the coordinated management of production rates and downtime.

**InduSoft Web Studio HMI Software Used to Automate Home:** John Rasmussen, a homeowner in Salt Lake City, Utah, was unable to find a suitable home automation system that could perform more than just a few functions and would also be easy to integrate, so he built his own, using the industrial-based InduSoft Web Studio HMI/SCADA software and a programmable logic controller (PLC). Not only did Rasmussen find the software flexible, but also affordable. "With industrial systems like the InduSoft Web Studio software and a PLC, I can connect valves, pumps, sensors, switches and video quite easily," he says. "With traditional home automation products, the choices are much more limited. I would have to buy separate systems for security, heating/cooling, and audio, and they would not work together. For the zone heating alone, I would have needed three commercial controllers with limited functionality, and all of them were sold separately!"



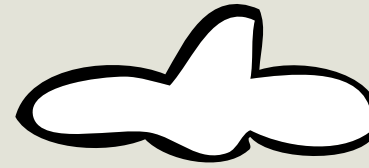
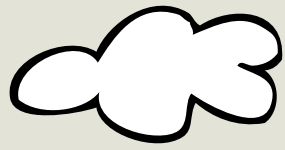

## The Growing Need for Security in Building Automation

Security plays a vital role in many recent building automation projects, and there is increasing demand for an all-in-one tool that has built-in capabilities for building automation and security. Many public buildings must meet security standards, as well as schools, detention centers, hospitals, and even manufacturing or storing food and beverages and pharmaceuticals. InduSoft has a unique insight in the security market, and has proven to be a software powerful and reliable enough for detention centers and prisons.

### ***Juvenile Facility Improves Security Measures Using InduSoft Web Studio to Run Multiple Systems:***

The Eaton County Youth Services juvenile treatment and detention facility is in Charlotte, Michigan. This 24 bed facility houses young people deemed to have “behavioral challenges.” To reduce problems with the detainees and monitor their movements, security personnel used an aging computer system to listen to sounds in each detainee’s room and other areas of the facility, so they could identify abnormal sounds, movements or activities. This system was replaced by a system designed with InduSoft Web Studio. Workers can monitor the status of doors, control access to the building, and listen to rooms from the control station.

### ***Sierra detention Systems – Helping to ensure the security of a community:***

Whether we like it or not, correctional facilities are a fact of civilized life. And as prison systems have evolved to become more sophisticated and secure, policies and procedures have evolved to ensure that security. Nobody is more aware of this evolution than Sierra Detention Systems, where InduSoft Web Studio has been used to develop a system that controls over 2,000 devices and 35 HMI screens. Using this system, the Adams County Sheriff’s office in Colorado can monitor every camera on the facility, and control the entire system from a mouse or touch screen input.

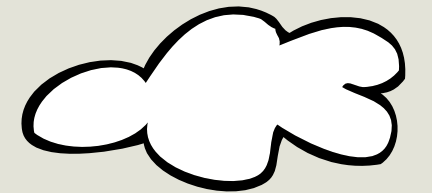
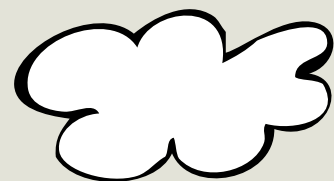

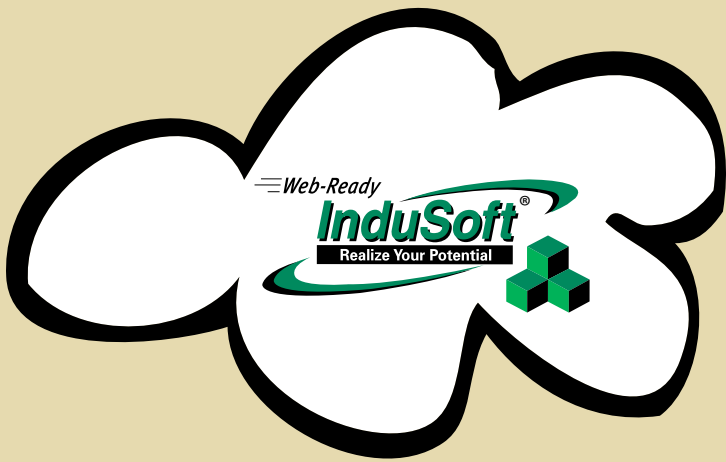

**indusoft.com**  
**info@indusoft.com**

