

GRUNDFOS DMB SERIES MANUAL



Quick Links

[Applications](#)

[Operating Conditions](#)

[General Information](#)

[Technical Data](#)

[Identification](#)

[General Description](#)

Table of Contents

Table of Contents

Applications

Service documentation

Operating conditions

Identification of safety instructions in this manual

Qualification and training of personnel

Risks when safety instructions are not observed

Safety-conscious working

Safety instructions for the operator/ user

Safety instructions for maintenance, inspection and installation work

Unauthorised modification and manufacture of spare parts⁴

Improper operating methods

Safety of the system in the event of a failure in the dosing system

Delivery

Unpacking

Return

Identification

General description

Installation location

Mounting

Installation tips

Tube / pipe lines

Version with mains plug

Initial start-up / subsequent start-up

Operating the pump

Shutdown

Control and display elements

Switching on/off

Operating the pump with control unit

Notes for stroke-length adjustment

Pumps with manual deaeration

General notes

Maintenance intervals

Cleaning suction and discharge valves

Replacing the diaphragm

Other ManualsLib Projects



MANUAL DE BOMBAS DOSIFICADORAS DMB

INSTRUCCIONES DE OPERACIÓN E INSTALACIÓN.



CONTENTS

1. General information	3	5.1 Installation location	6
1.1 Applications	3	5.2 Mounting	1
1.2 Service documentation	3	5.3 Installation tips	6
1.3 Operating conditions	3	5.4 Tube / pipe lines	7
2. Safety	4	6. Electrical connections	7
2.1 Identification of safety instructions in this manual.....	4	6.1 Version with mains plug	8
2.2 Qualification and training of personnel.....	4	7. Start-up / shutdown.....	8
2.3 Risks when safety instructions are not observed.....	4	7.1 Initial start-up / subsequent start-up	8
2.4 Safety-conscious working.....	4	7.2 Operating the pump	9
2.5 Safety instructions for the operator/ user	4	7.3 Shutdown.....	9
2.6 Safety instructions for maintenance, inspection and installation work.....	4	8. Operation.....	9
2.7 Unauthorised modification and manufacture of spare parts	4	8.1 Control and display elements.....	9
2.8 Improper operating methods.....	4	8.2 Switching on/off	10
2.9 Safety of the system in the event of a failure in the dosing system	5	8.3 Operating the pump with control unit	10
3. Transport	5	8.4 Notes for stroke-length adjustment	11
3.1 Delivery	5	8.5 Pumps with manual deaeration	11
3.2 Unpacking	5	9. Maintenance	11
3.3 Return	5	9.1 General notes.....	11
4. Technical data.....	5	9.2 Maintenance intervals.....	11
4.1 Identification	5	9.3 Cleaning suction and discharge valves.....	11
4.2 General description	5	9.4 Replacing the diaphragm	12
5. Installation	6	10. Fault finding chart	13
		11. Disposal	14



These basic installation and operating instructions contain the minimum of information that is needed to install, operate and maintain the DMB dosing pump. For more or advanced information, please contact Grundfos Alldos.

Prior to installation, read these installation and operating instructions. Installation and operation must comply with local regulations and accepted codes of good practice.

1. General information

1.1 Applications

The DMB pump is to be used strictly in accordance with the instructions in this manual.



Warning Other applications or the operation of pumps in ambient and operating conditions, which are not approved, are considered improper and are not permitted. Grundfos Alldos accepts no liability for any damage resulting from incorrect use.

Caution

In the event of questions regarding the material resistance and suitability of the pump for specific dosing media, please contact Grundfos Alldos.

1.2 Service documentation

If you have any questions, please contact the nearest Grundfos Alldos company or service workshop.

1.3 Operating conditions

1.3.1 Maximum inlet pressure

All DMB pumps: 0.2 bar

1.3.2 Minimum counter-pressure at the pump discharge valve

For all DMB pumps: 1 bar.

1.3.3 Maximum suction lift* (continuous operation) for media with a viscosity similar to water

All DMB pumps: 6 m

* Dosing head and valves moistened.

1.3.4 Sound pressure level

45 dB(A), testing according to DIN 45635-01-KL3.

1.3.5 Enclosure class

- Pump with mains plug: IP 65.
- Pumps with electronics: The enclosure class is only met if the sockets are protected! The data regarding the enclosure class applies to pumps with correctly inserted plugs or screwed-on caps.

1.3.6 Required energy

Power supply for AC voltage

- Rated voltage: 110 / 115 V or 230 / 240 V. Deviation from the rated value: $\pm 10\%$.
- Mains frequency: 50/60 Hz.
- Maximum input power: 22 W.

1.3.7 Ambient and operating conditions

- Permissible ambient temperature: 0 °C to +40 °C.
- Permissible storage temperature: -10 °C to +50 °C.
- Permissible air humidity: max. relative humidity: 92 % (non-condensing).



Warning The DMB is NOT approved for operation in potentially explosive areas!

The installation site must be under cover! Ensure that the enclosure class of motor and pump is not affected by the atmospheric conditions. Pumps with electronics are only suitable for indoor use! Do not install outdoors!

1.3.8 Dosing medium

The dosing medium must have the following basic characteristics:

- liquid
- non-abrasive
- non-inflammable.

1.3.9 Permissible media temperature

Min. media temperature: 0 °C

Max. media temperature: 40 °C



Warning Observe the chemical manufacturer's safety instructions when handling chemicals!

The dosing medium must be in liquid form!

Caution

Observe the freezing and boiling points of the dosing medium!

Caution

The resistance of the parts that come into contact with the media depends on the media, media temperature and operating pressure. Ensure that parts in contact with the media are chemically resistant to the dosing medium under operating conditions!

Make sure that the pump is suitable for the actual dosing medium!

2. Safety

This manual contains general instructions that must be observed during installation, operation and maintenance of the pump. This manual must therefore be read by the installation engineer and the relevant qualified personnel/operators prior to installation and start-up, and must be available at the installation location of the pump at all times.

It is not only the general safety instructions given in this "Safety" section that must be observed, but also all the specific safety instructions given in other sections.

2.1 Identification of safety instructions in this manual

If the safety instructions or other advice in this manual are not observed, it may result in personal injury or malfunction and damage to the pump. The safety instructions and other advice are identified by the following symbols:



Warning If these safety instructions are not observed, it may result in personal injury!

If these safety instructions are not observed, it may result in malfunction or damage to the equipment!

Notes or instructions that make the job easier and ensure safe operation.

Information provided directly on the pump, e.g. labelling of fluid connections, must be observed and must be maintained in a readable condition at all times.

2.2 Qualification and training of personnel

The personnel responsible for the operation, maintenance, inspection and installation must be appropriately qualified for these tasks. Areas of responsibility, levels of authority and the supervision of the personnel must be precisely defined by the operator.

If the personnel do not have the necessary knowledge, the necessary training and instruction must be given. If necessary, training can be performed by the manufacturer/supplier at the request of the operator of the pump. It is the responsibility of the operator to make sure that the contents of this manual are understood by the personnel.

2.3 Risks when safety instructions are not observed

Non-observance of the safety instructions may have dangerous consequences for the personnel, the environment and the pump. If the safety instructions are not observed, all rights to claims for damages may be lost.

2.4 Safety-conscious working

The safety instructions in this manual, applicable national health and safety regulations and any operator internal working, operating and safety regulations must be observed.

2.5 Safety instructions for the operator/ user

Hazardous hot or cold parts on the pump must be protected to prevent accidental contact. Leakages of dangerous substances (e.g. hot, toxic) must be disposed of in a way that is not harmful to the personnel or the environment. Legal regulations must be observed. Damage caused by electrical energy must be prevented (for more details, see for example the regulations of the VDE and the local electricity supply company).

2.6 Safety instructions for maintenance, inspection and installation work

The operator must ensure that all maintenance, inspection and installation work is carried out by authorised and qualified personnel, who have been adequately trained by reading this manual.

All work on the pump should only be carried out when the pump is stopped. The procedure described in this manual for stopping the pump must be observed.

Pumps or pump units which are used for media that are harmful to health must be decontaminated. All safety and protective equipment must be immediately restarted or put into operation once work is complete.

Observe the points described in the initial start-up section prior to subsequent start-up.

Warning



Electrical connections must only be carried out by qualified personnel!

The pump housing must only be opened by personnel authorised by Grundfos Aaldos!

2.7 Unauthorised modification and manufacture of spare parts

Modification or changes to the pump are only permitted following agreement with the manufacturer. Original spare parts and accessories authorised by the manufacturer are safe to use. Using other parts can result in liability for any resulting consequences.

2.8 Improper operating methods

The operational safety of the supplied pump is only ensured if it is used in accordance with section 1. General information. The

specified limit values must under no circumstances be exceeded.

2.9 Safety of the system in the event of a failure in the dosing system

DMB dosing pumps are designed according to the latest technologies and are carefully manufactured and tested. However, a failure may occur in the dosing system. Systems in which dosing pumps are installed must be designed in such a way that the safety of the entire system is still ensured following a failure of the dosing pump. Provide the relevant monitoring and control functions for this.

3. Transport

3.1 Delivery

The DMB dosing pump is delivered in a cardboard box. Place the pump in the packaging during transport and intermediate storage.

3.2 Unpacking

Retain the packaging for future storage or return, or dispose of the packaging in accordance with local regulations.

3.3 Return

Return the pump in its original packaging or equivalent. The pump must be thoroughly cleaned before it is returned or stored. It is essential that there are no traces of toxic or hazardous media remaining on the pump.

Caution

Grundfos Alldos accepts no liability for damage caused by incorrect transportation or missing or unsuitable packaging of the pump!

Before returning the pump to Grundfos Alldos for service, the **safety declaration** at the end of these instructions must be filled in by authorised personnel and attached to the pump in a visible position.

Caution

If a pump has been used for a medium which is injurious to health or toxic, the pump will be classified as contaminated.

If Grundfos Alldos is requested to service the pump, it must be ensured that the pump is free from substances that can be injurious to health or toxic. If the pump has been used for such substances, the pump must be cleaned before it is returned.

If proper cleaning is not possible, all relevant information about the chemical must be provided. If the above is not fulfilled, Grundfos Alldos can refuse to accept the pump for service. Possible costs of returning the pump are paid by the customer.

The safety declaration can be found at the end of these instructions.

Caution

The replacement of the power supply cable must be carried out by an authorised Grundfos Alldos service workshop.

4. Technical data

4.1 Identification

See fig. 1 on page 15.

Pos.	Description
1	Type designation
2	Model
3	Maximum capacity [l/h]
4	Voltage [V]
5	Frequency [Hz]
6	Product number
7	Year and week code
8	Maximum pressure [bar]
9	Serial number

4.2 General description

4.2.1 DMB with manual deaeration

See fig. 2 on page 15.

Pos.	Components
3a	Suction valve
3b	Discharge valve
2a	Dosing head with manual deaeration

I	Connection for deaeration line
V	Deaeration screw for manual deaeration

5. Installation

5.1 Installation location

Caution Observe the permissible air humidity and the permissible ambient operation temperature, see section 1.3.7
Ambient and operating conditions.

5.1.1 Space required for operation and maintenance

Caution The pump must be installed in a position where it is easily accessible during operation and maintenance work.

The control elements must be easily accessible during operation. Maintenance work on the dosing head and the valves must be carried out regularly. Provide sufficient space for removing the dosing head and the valves.

5.1.2 Mounting surface

The pump must be mounted on a flat surface.

5.2 Mounting

Caution Carefully tighten the screws, otherwise the plastic housing may be damaged.

5.2.1 Horizontal mounting

See fig. 3 on page 15.

- Use four M6 screws to mount the pump on the tank or on a console so that the suction valve is at the bottom and the discharge valve is at the top (dosing always flows upwards).

5.2.2 Installation examples

See fig. 4 on page 15.

Pos. Components

1i	Dosing tank
2i	Electric agitator
3i	Extraction device
5i	Dosing pump
6i	Relief valve
7i	Pressure-loading valve
9i	Calibration tube
10i	Injection unit
15i	Filter

5.3 Installation tips

- For non-degassing media with a viscosity similar to water, the pump can be mounted on the tank (observe the permissible suction lift).
- Flooded suction preferred (not with Plus³ system).
- For media with a tendency to sedimentation, install the suction line with filter so that the suction valve remains a few millimetres above the possible level of sedimentation.

With open outflow of the dosing medium or low counter-pressure

A positive pressure difference of at least 1 bar must be ensured between the counter-pressure at the injection point and the pressure of the dosing medium at the pump suction valve.

- If this cannot be ensured, install a pressure-loading valve immediately before the outlet or the injection unit.

Installation to avoid the siphon effect

See fig. 5 on page 16.

- To avoid the siphon effect, install a pressure-loading valve (7i) in the discharge line and, if necessary, a solenoid valve (14i) in the suction line.

Installation with pressure relief valve and filter

See fig. 6 on page 16.

To protect the dosing pump against excessive pressure build-up, install a relief valve (6i) in the discharge line.

- For degassing media:
 - Flooded suction

- Install a filter (15i) in the suction line to prevent the valves being contaminated.

When installing the suction line, observe the following:

- Keep the suction line as short as possible. Prevent it from becoming tangled.
- If necessary, use swept bends instead of elbows.
- Always route the suction line up towards the suction valve.
- Avoid loops as they may cause air bubbles.

In the case of long discharge lines, install a non-return valve (12i) in the discharge line.

5.4 Tube / pipe lines

5.4.1 General



WarningTo protect the dosing pump against excessive pressure build-up, install a relief valve in the discharge line. All lines must be free from strain!

Avoid loops and buckles in the tubes! Keep the suction line as short as possible!

The flow must run in the opposite direction to gravity! Observe the manufacturer's safety instructions when handling chemicals!

The resistance of the parts that come into contact with the media depends on the media, media temperature and operating pressure. Ensure that parts in contact with the media are chemically resistant to the dosing medium under operating conditions!

Only use the specified line types!

5.4.2 Sizing of tube / pipe lines



Warning PVC tube DN 4 is not suitable for use as a discharge line! Connect PE tube DN 4 on the discharge side!

Warning Observe the pressure stage of the used lines. The maximum permissible inlet pressure must not be exceeded!

Minimum internal diameter

Pump version

Pump type	Standard [mm]
DMB 1.0-10 - DMB 5.0-6	4
DMB 9.0-6 DMB 18-3.5	6

5.4.3 Connecting the suction and discharge lines



Warning All lines must be free from strain! Only use the prescribed line types!

- Connect the suction line to the suction valve (3a).
 - Install the suction line in the tank so that the foot valve remains a few millimetres above the possible level of sedimentation.
- Connect the discharge line to the discharge valve (3b).

5.4.4 Connecting the overflow and deaeration lines



Warning Observe chemical resistance!

For all DMB pumps

See fig. 7 on page 16

The pump has a deaeration line (PVC 4/6).

- Connect the deaeration line (J) to the connection for the deaeration line (I).

5.4.5 Installing the overflow and deaeration lines

- Shorten the overflow line and deaeration line to at least 10 mm above the maximum tank level.
- Insert the overflow line and deaeration line downwards into the dosing tank or collection container. Avoid loops.

Dosing medium can leak from the overflow and deaeration lines. Route both lines into a collection container or the tank! Do not immerse the overflow line and deaeration line in the dosing medium!

Observe the pressure limits specified in section 1. General information!

6. Electrical connections

Make sure that the pump is suitable for the electricity supply on which it will be used.



Warning Electrical connections must only be carried out by qualified personnel! Disconnect the power supply before connecting the power supply cable and the relay contacts! Observe the local safety regulations!



Warning The pump housing must only be opened by personnel authorised by Grundfos Alldos!



Warning Protect the cable connections and plugs against corrosion and humidity. Only remove the protective caps from the sockets that are being used.

The power supply must be electrically isolated from the signal inputs and outputs.

The pump can be automatically started by connecting the power supply!

The assignment between the plug-and-socket connection and the pump must be labelled clearly (e.g. by labelling the socket outlet).

- Do not switch on the power supply until you are ready to start the pump.

6.1 Version with mains plug

- Insert the mains plug in the mains socket.

7. Start-up / shutdown



Warning Risk of chemical burns! Wear protective clothing (gloves and goggles) when working on the dosing head, connections or lines!

Before each start-up, check the dosing head screws. After initial start-up and after each time the diaphragm is changed, tighten the dosing head screws. After approximately 6-10 operating hours or two days, cross-tighten the dosing head screws using a torque wrench.

Maximum torque: DMB 1.0 - DMB 5.0: 2.1 Nm. DMB 9.0 - DMB 18: 2.5 Nm.

Adjust the stroke length only while the pump is running!

7.1 Initial start-up / subsequent start-up

7.1.1 Checks before start-up

- Check that the rated voltage stated on the pump nameplate corresponds to the local conditions!
- Check that all connections are secure and tighten, if necessary.
- Check that the dosing head screws are tightened with the specified torque and tighten, if necessary.
- Check that all electrical connections are correct.

7.1.2 Assisting suction for systems without dosing medium flooded suction

At the dry suction/discharge valves:

- 1 Remove the suction line.
- 2 Hold a small container of water directly next to the suction valve and draw water until the dosing head is full.
- 3 Reinsert the suction line.

7.1.3 Starting pump without automatic deaeration

- 1 Open the suction and discharge isolating valves, if installed.
- 2 Open the deaeration valve of the dosing head by approximately 1 or 2 turns.
- 3 Let the pump run in continuous operation:
 - Switch on the power supply.
 - Pumps with electronics: Press the "continuous operation" button and keep it pressed.
 - The pump switches to continuous operation at maximum stroke frequency.
 - Set the stroke-length adjustment knob to maximum.
- 3 Leave the pump running until the dosed medium is free of air bubbles.
- 4 Carefully close the deaeration valve.
 - The pump is now ready for operation.

7.1.4 Tightening dosing head screws

After initial start-up and after each time the diaphragm is changed, tighten the dosing head screws.

After approximately 6-10 operating hours or two days, cross-tighten the dosing head screws using a torque wrench.

Maximum torque: DMB 1.0 - DMB 5.0: 2.1 Nm. DMB 9.0 - DMB 18: 2.5 Nm.

7.2 Operating the pump

To operate the pump, refer to sections 8. Operation and 9. Maintenance, and if necessary, section 10. Fault finding chart in the event of a fault.

7.3 Shutdown

Warning Risk of chemical burns! Wear protective clothing (gloves and goggles) when working on the dosing head, connections or lines! Do not allow any chemicals to leak from the pump. Collect and dispose of all chemicals correctly!

If possible, rinse the dosing head before shutting down the pump, e.g. by supplying it with water.

7.3.1 Switching off / uninstalling

- 1 Switch off the pump and disconnect it from the power supply.
- 2 Depressurise the system.
- 3 Take suitable steps to ensure that the returning dosing medium is safely collected.
- 4 Carefully remove all lines.
- 5 Uninstall the pump.

7.3.2 Cleaning

1. Rinse all parts that have come into contact with the medium very carefully:
 - lines
 - valves
 - dosing head
 - diaphragm.
2. Remove any trace of chemicals from the pump housing.

7.3.3 Storage

Storage of the pump:

- 1 After cleaning (see above), carefully dry all parts and reinstall the dosing head and valves, or
- 2 change the valves and diaphragm. See section 9. Maintenance.

8. Operation

Warning Faults, incorrect operation or faults on the pump or system can, for example, lead to excessive or insufficient dosing, or the permissible pressure may be exceeded. Consequential faults or damage must be evaluated by the operator and appropriate precautions must be taken to avoid them!

In the event of a diaphragm leakage, the dosing liquid may leak out of the hole in the intermediate flange between the pump and the dosing head. The parts inside the housing are protected from the dosing liquid for a short time (depending on the type of liquid) by the housing sealing. It is necessary to check regularly (daily) if liquid is leaking out of the intermediate flange.

For maximum safety, we recommend the pump version with diaphragm leakage detection.



8.1 Control and display elements





8.1.1 Stroke-length adjustment

Adjust the stroke length only while the pump is running!

8.1.2 Control and display elements for pumps with control unit

See fig. 6 on page 16

Element	Description
	Light-emitting diode (LED) Lights up red when the pump is stopped. Lights up green when the pump is started and briefly turns off during a suction stroke. Flashes red if an error signal is present.
 	Manual / Contact LEDs Either "Manual" or "Contact" lights up green, depending on the operating mode.

	"Continuous operation" button for continuous operation.
	Use the "Menu/Info" button to switch between the operating modes.
 	For setting the dosing flow in "Manual control" ("Manual") or "Contact signal control" ("Contact") mode.

8.2 Switching on/off

Before switching on the pump, check that it is installed correctly. Refer to sections 5. Installation and 7.1

Initial start-up / subsequent start-up.

8.2.1 Switching on the pump

- Switch on the power supply.

8.2.2 Switching off the pump

- Switch off the power supply.

8.3 Operating the pump with control unit

8.3.1 Continuous operation

For suction or deaeration, switch the pump to continuous operation, without modifying the selected operating mode and dosing flow settings.

The pump doses at maximum stroke rate. The stroke length remains the same.

- Press the "continuous operation" button.

8.3.2 Selecting the operating mode

The available operating modes are "Manual control" and "Contact signal control". Use the "Menu/Info" button to switch between the operating modes.

- Press the "Menu/Info" button and keep it pressed for approximately 2 seconds.
 - The LED for the new operating mode flashes and then lights up continuously after approximately 2 seconds. The LED for the old operating mode turns off.

The selected operating mode is indicated by the relevant LED.

8.3.3 Setting the dosing flow in "Manual control" mode

In general, keep the stroke length setting as high as possible, and adjust the flow rate using the stroke frequency.

In "Manual control" mode, set the desired dosing flow by modifying the stroke frequency in the range between 0 % and 100 %. The internal scale applies.

8.3.4 Setting the dosing flow in "Contact signal control" mode

In general, keep the stroke length setting as high as possible, and adjust the flow rate using the stroke frequency.

In "Contact signal control" mode, set the desired dosing flow by modifying the number of strokes per contact signal received. The external scale applies.

The pump makes the set number of dosing strokes		
Setting	Function	Number of strokes per contact signal
1:1	1:1	The pump makes one dosing stroke per contact signal received.
1:n	Multiplier	The pump makes the set number of dosing strokes per contact signal received, e.g. 16 strokes per contact signal for the setting 1:16.

n:1	Divisor	The pump makes one dosing stroke after the set number of contact signals has been received, e.g. one stroke for every 4 contact signals for the setting 4:1.
-----	---------	--------------------------------------------------------------------------------------------------------------------------------------------------------------

Even if the pump receives more contact signals than it can process at maximum stroke frequency, the pump runs for as long as possible in continuous operation with a maximum stroke frequency.

8.4 Notes for stroke-length adjustment

In general, keep the stroke length setting as high as possible, and adjust

8.5 Pumps with manual deaeration

Manual deaeration of the dosing head (while the pump is running)

- 1 Open the deaeration valve (V) of the dosing head by approximately 1 turn (2 turns with Plus³ system).
- 2 Press the "Start/Stop" button and keep it pressed.
 - The pump switches to continuous operation.
- 3 Leave the pump running until the medium flowing from the deaeration line (J) is free of air bubbles.
- 4 Carefully close the deaeration valve.

9. Maintenance

In the event of a diaphragm leakage, the dosing liquid may leak out of the hole in the intermediate flange between the pump and the dosing head. The parts inside the housing are protected from the dosing liquid for a short time (depending on the type of liquid) by the housing sealing. It is necessary to check regularly (daily) if liquid is leaking out of the intermediate flange.

For maximum safety, we recommend the pump version with diaphragm leakage detection.

9.1 General notes

Warning When dosing dangerous media,

observe the corresponding safety precautions! Risk of chemical burns! Wear protective clothing (gloves and goggles) when working on the dosing head, connections or lines! Do not allow any chemicals to leak from the pump. Collect and dispose of all chemicals correctly!

Warning The pump housing must only be opened by personnel authorised by Grundfos Aaldos! Repairs must only be carried out by authorised and qualified personnel! Switch off the pump and disconnect it from the power supply before carrying out maintenance work and repairs!

If possible, rinse the dosing head, e.g. by supplying it with water.

9.2 Maintenance intervals

At least every 12 months or after 4000 operating hours. When dosing crystallising liquids, more frequently.

In the event of a fault.

9.2.1 Cleaning the valves and diaphragm

- Clean the diaphragm and valves and replace, if necessary (for stainless-steel valves: inner valve parts).

9.3 Cleaning suction and discharge valves

9.3.1 Switching off the pump

- 1 Switch off the pump and disconnect it from the power supply.
- 2 Depressurise the system.
- 3 Take suitable steps to ensure that the returning dosing medium is safely collected.

9.3.2 Unscrewing suction and discharge valves/ cleaning valves

- 1 Unscrew the suction and discharge valves.

Dismantle the inner valve parts: Standard DN 4/DN 8 valve: See fig. 15 on page 327.

- 2 – Carefully push out the inner valve part using a thin wire nail (or paper clip) in the flow direction (see arrow on the valve body).

- Dismantle the inner parts: seat (4r), O-ring (1r), balls (3r), ball cages (2r).
 - Unscrew the valve cover.
3. Clean all parts. If faulty parts are detected, proceed as follows:
- Replace the valve (for stainless-steel valves: inner valve parts). For contents and order numbers of the spare parts kits, contact Grundfos Alldos.
- 1 Re-assemble and refit the valve.
 - 2 Remove the deaeration cartridge (1p, 2p, 3p) under the discharge valve from the dosing head using a pair of tweezers.
 - Dismantle the cartridge.
 - Clean the cartridge. If faulty parts are detected, proceed as follows:
 - Replace the deaeration cartridge. For contents and order numbers of the spare parts kits, contact Grundfos Alldos.
 - Re-assemble the cartridge.
6. Refit all parts. See fig. 10 on page 16.

The O-rings must be correctly placed in the specified groove.

Observe the flow direction (indicated by an arrow)! Only tighten the valve by hand.

9.4 Replacing the diaphragm

9.4.1 Switching off the pump

- 1 While the pump is running, set the stroke-length adjustment knob to 100 %.
- 2 Switch off the pump and disconnect it from the power supply.
- 3 Depressurise the system.
- 4 Take suitable steps to ensure that the returning dosing medium is safely collected.

9.4.2 Replacing the diaphragm

See fig. 11 on page 16.

- 1 Loosen the four screws (1q + 2q) on the dosing head (2).
- 2 Remove the dosing head (2).
3. Unscrew the diaphragm (Q₃) counter-clockwise.
 - For pumps without Plus system: Replace the sealing diaphragm (3q), intermediate ring (4q) and support disk (5q).
- 4 Screw in the new diaphragm (Q).
- 5 Start/stop the pump briefly so that the diaphragm is set to the back dead point (end of suction stroke).
- 6 Replace the dosing head (2) and cross-tighten the screws (1q + 2q).
Maximum torque: DMB 1.0 - DMB 5.0: 2.1 Nm. DMB 9.0 - DMB 18: 2.5 Nm.
- 7 Vent and start up the dosing pump.

After initial start-up and after each time the diaphragm is changed, tighten the dosing head screws.

After approximately 6-10 operating hours or two days, cross-tighten the dosing head screws using a torque wrench.

Maximum torque: DMB 1.0 - DMB 5.0: 2.1 Nm. DMB 9.0 - DMB 18: 2.5 Nm.

10. Fault finding chart

Fault	Cause	Remedy
1. Dosing pump does not run.	a) Not connected to the mains.	Connect the power supply cable.
	b) Incorrect mains voltage.	Switch off the pump. Check voltage and motor. If the motor is faulty, return the pump for repair.
	c) Electrical failure.	Return the pump for repair.
2. Dosing pump does not suck in.	a) Leaking suction line.	Replace or seal the suction line.
	b) Cross-section of the suction line too small or suction line too long.	Check with Grundfos Alldos specification.
	c) Clogged suction line.	Rinse or replace the suction line.
	d) Foot valve covered by sediment.	Suspend the suction line from a higher position.
	e) Buckled suction line.	Install the suction line correctly. Check for damage.
	f) Crystalline deposits in the valves.	Clean the valves.
	g) Diaphragm broken or diaphragm tappet torn out.	Replace the diaphragm.
	h) Empty dosing tank.	Fill the dosing tank.
3. Dosing pump does not dose.	a) Air in the suction line and dosing head.	Fill the dosing head and suction line.
	b) Viscosity or density of medium too high.	Check the installation.
	c) Crystalline deposits in the valves.	Clean the valves.
	d) Valves not correctly assembled.	Assemble the inner valve parts in the right order and check or possibly correct the flow direction.
	e) Injection unit blocked.	Check and possibly correct the flow direction, or remove the obstruction.
	f) Incorrect installation of lines and peripheral equipment.	Check the lines for free passage and correct installation.
	g) Empty dosing tank.	Fill the dosing tank.
	h) Sealing elements not chemically resistant.	Replace sealing elements.

Fault	Cause	Remedy
4. Dosing flow of the pump is inaccurate.	a) Dosing head not fully deaerated.	Repeat the deaeration.
	b) Degassing medium.	Check the installation.
	c) Parts of the valves covered in dirt or incrusted.	Clean the valves.
	d) Counter-pressure fluctuations.	Install a pressure-loading valve and a pulsation damper, if necessary.
	e) Suction lift fluctuations.	Keep the suction level constant.
	f) Siphon effect (inlet pressure higher than counter-pressure).	Install a pressure-loading valve.
	g) Leaking or porous suction line or discharge line.	Replace the suction line or discharge line.
	h) Parts in contact with the medium are not resistant to it.	Replace with resistant materials.
	i) Dosing diaphragm worn (incipient tears).	Replace the diaphragm. Also observe the maintenance instructions.
	j) Variation of the dosing medium (density, viscosity).	Check the concentration. Use an agitator, if necessary.
5. Liquid leaks out of the hole in the intermediate flange between the pump and the dosing head.	a) A diaphragm leakage has occurred.	Replace the diaphragm.

11. Disposal

This product or parts of it must be disposed of in an environmentally sound way:

- 1 Use appropriate waste collection services.
- 2 If this is not possible, contact the nearest Grundfos or Grundfos Alldos company or service workshop.

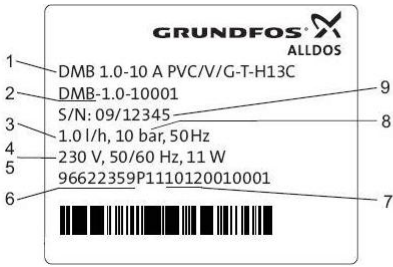

Fig. 1 DMB nameplate

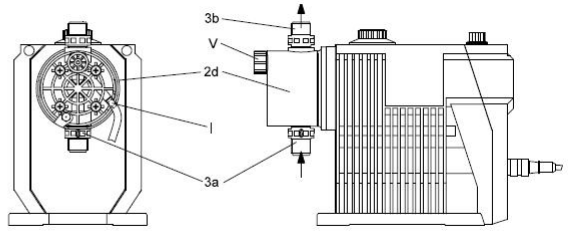

Fig. 2 DMB with manual deaeration

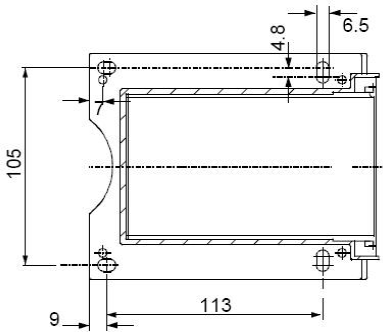

Fig. 3 Filling scheme

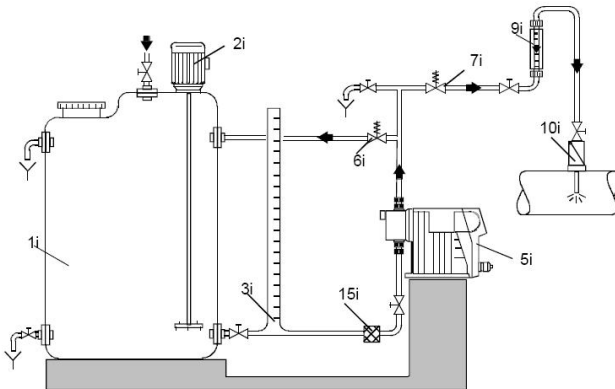

Fig. 4 Installation example of pump with manual deaeration

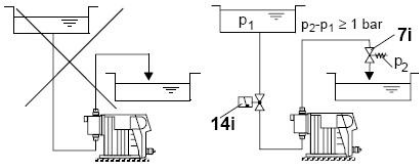

Fig. 5 Installation to avoid the siphon effect

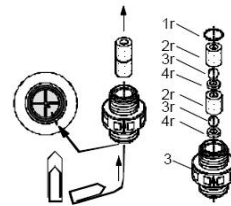

Fig. 9 Standard DN4/DN8 valve

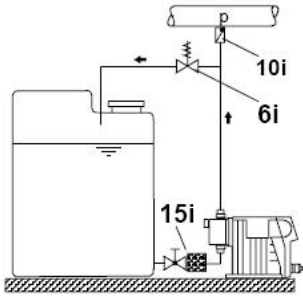

Fig. 6 Installation with relief valve and filter

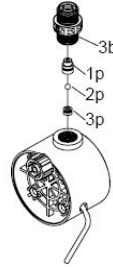

Fig. 10 Standard DN4/DN8 valve

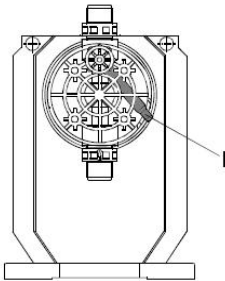

Fig. 7 Connecting the deaeration line to pumps
With manual deaeration

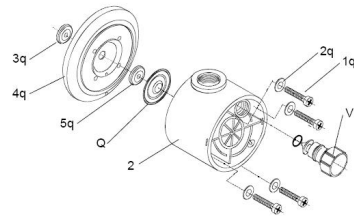

Fig. 11 Replace diaphragm

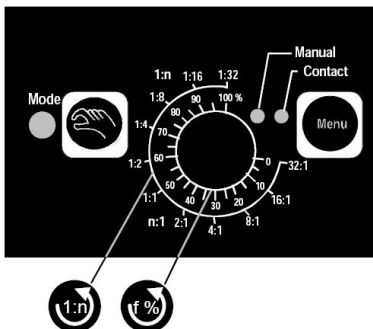

Fig. 8 Display of pumps with control unit

Neuquén

J.J. Lastra 1120 (8300)
Tel/Fax: 0299 442 8380
ventas@leonindustrial.com.ar

Comodoro Rivadavia

Tel. 0297 446 1329
ventascr@leonindustrial.com.ar

Buenos Aires

Av. Roque Sáenz Peña 615
Tercer piso, oficina 309 (C1035AAB)
ventasbsas@leonindustrial.com.ar

Other ManualsLib Projects



www.manualslib.com



www.manualslib.de



www.manualslib.es



www.manualslib.fr



www.manualslib.nl



www.manualslib.mx



www.manualslib.tech 30+ Languages