



ESM-7710 72 x 72 DIN Size Digital, On/Off Temperature Controller

- 3 Digits display
- NTC Input or,
PTC Input or,
J type thermocouple or,
K type thermocouple or,
PT-100 2-wire or 3-wire temperature input
(It must be determined in order)
- ON/OFF control form
- Selectable heating and cooling function
- Operating type selection with hysteresis
- Adjustment of temperature offset value
- Minimum pulling time adjustment for control outputs
- Password protection for programming mode

ABOUT INSTRUCTION MANUAL

Instruction manual of ESM-7710 Temperature Controller consists of three main sections. Explanation of these sections are below. Also, there are other sections which include order information and technical specifications of the device. All titles and page numbers in instruction manual are in “**CONTENTS**” section. User can reach to any title with section number.

Installation:

In this section, physical dimensions of the device, panel mounting, electrical wiring are explained.

Operation and Parameters:

In this section, user interface of the device, how to access to the parameters, description of the parameters are explained.

Control Algorithm:

Configurable control function that is on the device is explained.

Also in these sections, there are warnings to prevent serious injury while doing the physical and electrical mounting or using the device.

Explanation of the symbols which are used in these sections are given below.



This symbol is used for safety warnings. User must pay attention to these warnings.



This symbol is used to determine the dangerous situations as a result of an electric shock. User must pay attention to these warnings definitely.



This symbol is used to determine the important notes about functions and usage of the device.

CONTENTS

1.PREFACE	Page	5
1.1 GENERAL SPECIFICATIONS		
1.2 ORDERING INFORMATION		
1.3 WARRANTY		
1.4 MAINTENANCE		
2.INSTALLATION	Page	7
2.1 GENERAL DESCRIPTION		
2.2 FRONT VIEW AND DIMENSIONS OF ESM-7710 TEMPERATURE CONTROLLER WITH ONE RELAY		
2.3 FRONT VIEW AND DIMENSIONS OF ESM-7710 TEMPERATURE CONTROLLER WITH TWO RELAYS		
2.4 PANEL CUT-OUT		
2.5 ENVIRONMENTAL RATINGS		
2.6 PANEL MOUNTING		
2.7 INSTALLATION FIXING CLAMP		
2.8 REMOVING FROM THE PANEL		
3.ELECTRICAL WIRINGS	Page	12
3.1 TERMINAL LAYOUT AND CONNECTION INSTRUCTIONS		
3.2 ELECTRICAL WIRING DIAGRAM		
3.3 LABELS FOR ESM-7710 TEMPERATURE CONTROLLER WITH ONE RELAY		
3.4 LABELS FOR ESM-7710 TEMPERATURE CONTROLLER WITH TWO RELAYS		
3.5 SUPPLY VOLTAGE INPUT CONNECTION OF THE DEVICE		
3.6 TEMPERATURE INPUT CONNECTION		
3.6.1 TC (THERMOCOUPLE) CONNECTION		
3.6.2 RTD CONNECTIONS		
3.6.3 PTC AND NTC CONNECTIONS		
3.7 GALVANIC ISOLATION TEST VALUES OF ESM-7710 TEMPERATURE CONTROLLER		
3.8 OUTPUT-1 CONNECTIONS		
3.8.1 OUTPUT-1 (RELAY OUTPUT) CONNECTION		
3.8.2 OUTPUT-1 DRIVER OUTPUT CONNECTION		
3.9 OUTPUT-2 CONNECTIONS		
3.9.1 OUTPUT-2 (RELAY OUTPUT) CONNECTION		
3.9.2 OUTPUT-2 DRIVER OUTPUT CONNECTION		
4.FRONT PANEL DEFINITION AND ACCESSING TO THE MENUS	Page	21
4.1 FRONT PANEL DEFINITION FOR ESM-7710 WITH ONE RELAY		
4.2 FRONT PANEL DEFINITION FOR ESM-7710 WITH TWO RELAYS		
4.3 OBSERVATION OF ESM-7710 TEMPERATURE CONTROLLER SOFTWARE REVISION		
4.4 CHANGING AND SAVING SET VALUES		
4.4.1 ESM-7710 WITH ONE RELAY		
4.4.2 ESM-7710 WITH TWO RELAYS		
4.5 ENTERING TO PROGRAMMING MODE, CHANGING AND SAVING PARAMETERS		
4.5.1 ESM-7710 WITH ONE RELAY		
4.5.2 ESM-7710 WITH TWO RELAYS		
5.PARAMETERS	Page	41
5.1 SET PARAMETERS		
5.2 PROGRAM PARAMETERS		
6.FAILURE MESSAGE IN ESM-7710 TEMPERATURE CONTROLLERS	Page	43
7.CONTROL ALGORITHM	Page	44
7.1 ON/OFF CONTROL		
7.1.1 ON/OFF CONTROL IN ESM-XX10 TEMPERATURE CONTROLLERS		
8.SPECIFICATIONS	Page	45
9.OTHER INFORMATIONS	Page	46

EU DECLARATION OF CONFORMITY

Manufacturer's Name : EMKO ELEKTRONIK A.S.
Manufacturer's Address : DOSAB, Karanfil Sk., No:6,
16369 Bursa, TURKEY

The manufacturer hereby declares that the product:

Product Name : Temperature Controller Unit
Type Number : ESM-7710
Product Category : Electrical equipment for measurement, control and laboratory use

Conforms to the following directives :

2006 / 95 / EC The Low Voltage Directive

2004 / 108 / EC The Electromagnetic Compatibility Directive

has been designed and manufactured to the following specifications:

EN 61000-6-4:2007 EMC Generic Emission Standard for Industrial Environments

EN 61000-6-2:2005 EMC Generic Immunity Standard for Industrial Environments

EN 61010-1:2001 Safety Requirements for electrical equipment for measurement, control and laboratory use

When and Where Issued

16th October 2009

Bursa-TURKEY

Authorized Signature

Name : Serpil YAKIN

Position : Quality Manager

1. Preface

ESM series temperature controllers are designed for measuring and controlling temperature. They can be used in many applications with On/Off control form and heating and cooling selection. Some application fields which they are used are listed below:

Application Fields

Glass
Plastic
Petro-Chemistry
Textile
Automotive
Machine Production Industries

1.1 General Specifications

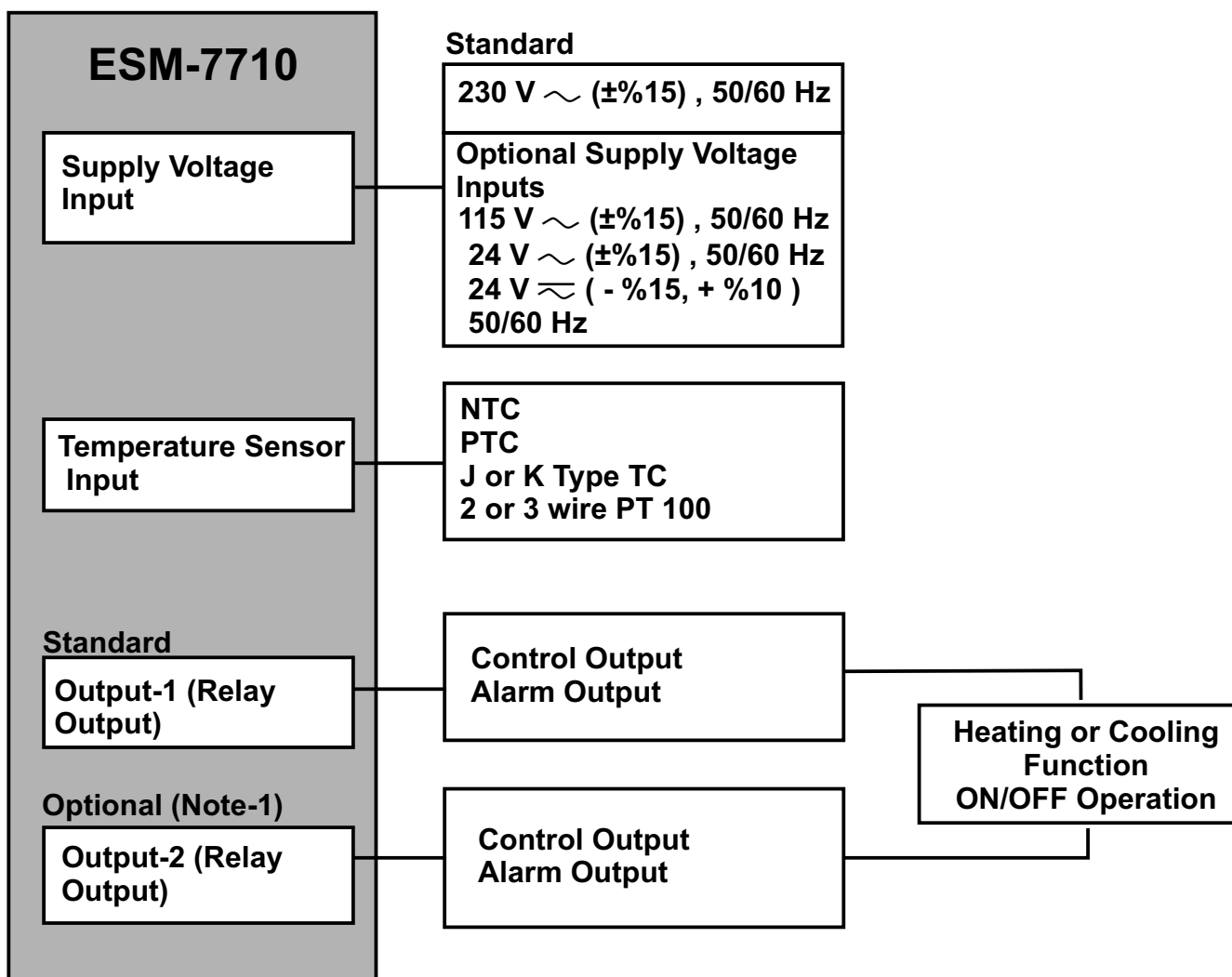

Note-1: Optional Relay output is standard in ESM-7710 with two relays

1.2 Ordering Information

ESM-7710 (72x72 DIN Size)	A	BC	D	E	/	FG	HI	/	U	V	W	Z
			0		/	00		/	2		0	0

A	Supply Voltage
2	24 V \sim (- %15, + %10) 50/60 Hz
3	24 V \sim (\pm %15) 50/60 Hz
4	115 V \sim (\pm %15) 50/60 Hz
5	230 V \sim (\pm %15) 50/60 Hz
9	Customer

BC	Input Type	Scale(°C)	
12	PTC (Note-1)	-50°C	150°C
15	PTC (Note-1)	-19.9°C	99.9°C
09	PT 100 , IEC751(ITS90)	-19.9°C	99.9°C
03	PT 100 , IEC751(ITS90)	0°C	400°C
05	J ,Fe CuNi IEC584.1(ITS90)	0°C	800°C
10	K ,NiCr Ni IEC584.1(ITS90)	0°C	999°C
18	NTC (Note-1)	-50°C	100°C
19	NTC (Note-1)	-19.9°C	99.9°C

Note-1 : If input type is selected PTC or NTC (BC = 12, 15, 18, 19), Temperature sensor is given with the device. For this reason, If input type is selected as PTC, sensor type (V = 0, 1 or 2) or If input type is selected as NTC, sensor type (V = 0, 3 or 4) must be declared in ordering information.

E	Output-1
1	Relay Output(7A@250V \sim at resistive load,1NO+1NC)
2	SSR Driver Output (Maximum 23mA,15V)
FG	Output-2
00	None
01	Relay Output(7A@250V \sim at resistive load,1NO)
02	SSR Driver Output (Maximum 23mA,15V)
V	Temp.Sensor which is given with ESM-7710
0	None
1	PTC-M6L40.K1.5(PTC Air probe with 1.5 m silicon cable)
2	PTCS-M6L30.K1.5.1/8"(PTC Liquid probe with 1.5 m silicon cable)
3	NTC-M5L20.K1.5 (NTC Probe, thermoplastic moulded with 1.5 m cable for cooling application)
4	NTC-M6L50.K1.5 (NTC Probe, stainless steel housing with 1.5 m cable for cooling application)
9	Customer

All order information of ESM-7710 Temperature Controller are given on the table at left. User may form appropriate device configuration from information and codes that at the table and convert it to the ordering codes.

Firstly, supply voltage then other specifications must be determined. Please fill the order code blanks according to your needs.

Please contact us, if your needs are out of the standards.



\sim Vac,
 \equiv Vdc,
 \sim Vacdc

1.3 Warranty

EMKO Elektronik warrants that the equipment delivered is free from defects in material and workmanship. This warranty is provided for a period of two years. The warranty period starts from the delivery date. This warranty is in force if duty and responsibilities which are determined in warranty document and instruction manual performs by the customer completely.

1.4 Maintenance

Repairs should only be performed by trained and specialized personnel. Cut power to the device before accessing internal parts.

Do not clean the case with hydrocarbon-based solvents (Petrol, Trichlorethylene etc.). Use of these solvents can reduce the mechanical reliability of the device. Use a cloth dampened in ethyl alcohol or water to clean the external plastic case.

2. Installation



Before beginning installation of this product, please read the instruction manual and warnings below carefully.

In package ,

- One piece unit
- Two pieces mounting clamps
- One piece instruction manual

A visual inspection of this product for possible damage occurred during shipment is recommended before installation. It is your responsibility to ensure that qualified mechanical and electrical technicians install this product.

If there is danger of serious accident resulting from a failure or defect in this unit, power off the system and separate the electrical connection of the device from the system.

The unit is normally supplied without a power switch or a fuse. Use power switch and fuse as required.

Be sure to use the rated power supply voltage to protect the unit against damage and to prevent failure.

Keep the power off until all of the wiring is completed so that electric shock and trouble with the unit can be prevented.

Never attempt to disassemble, modify or repair this unit. Tampering with the unit may results in malfunction, electric shock or fire.

Do not use the unit in combustible or explosive gaseous atmospheres.

During the equipment is putted in hole on the metal panel while mechanical installation some metal burrs can cause injury on hands, you must be careful.

Montage of the product on a system must be done with it's own fixing clamps. Do not do the montage of the device with inappropriate fixing clamp. Be sure that device will not fall while doing the montage.

It is your responsibility if this equipment is used in a manner not specified in this instruction manual.

2.1 General Description

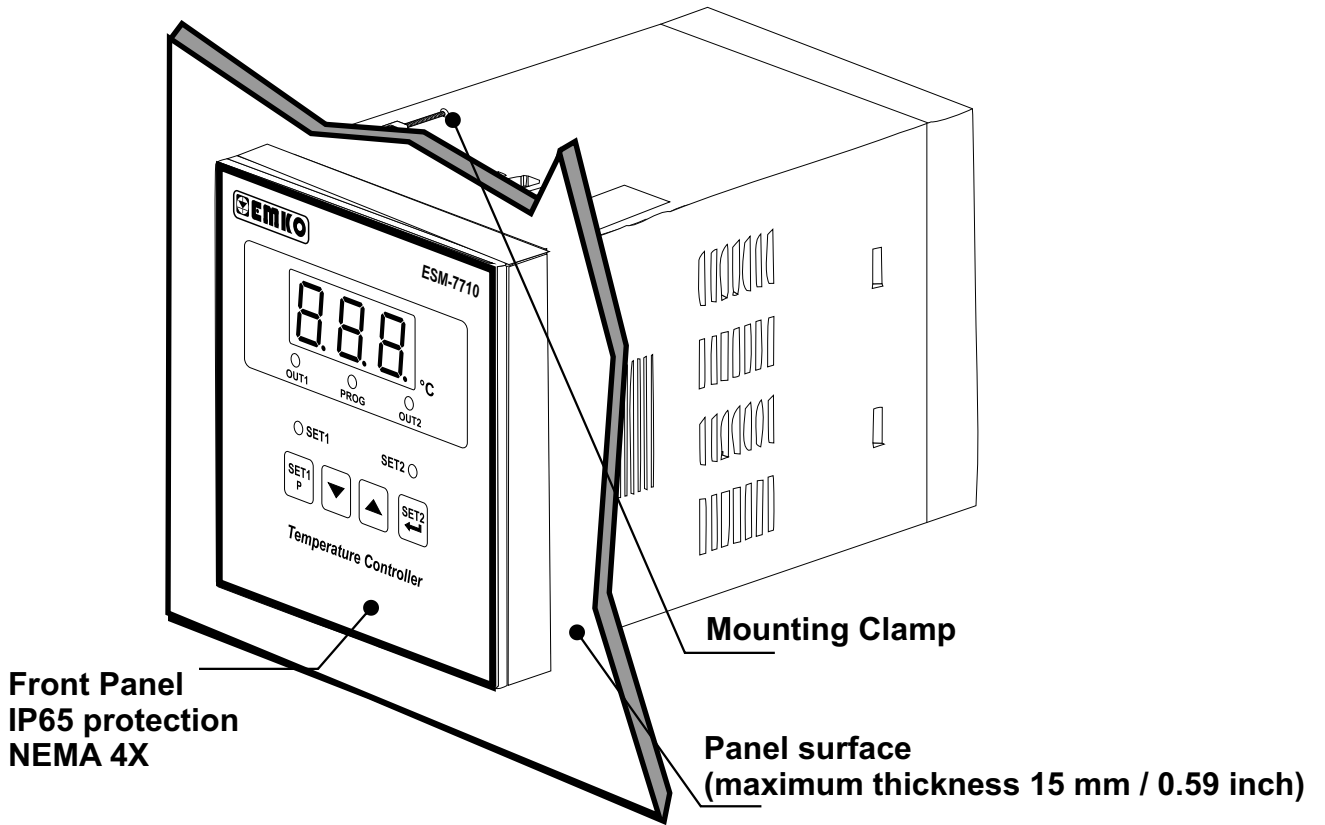

2.2 Front View and Dimensions of ESM-7710 Temperature Controller with One Relay

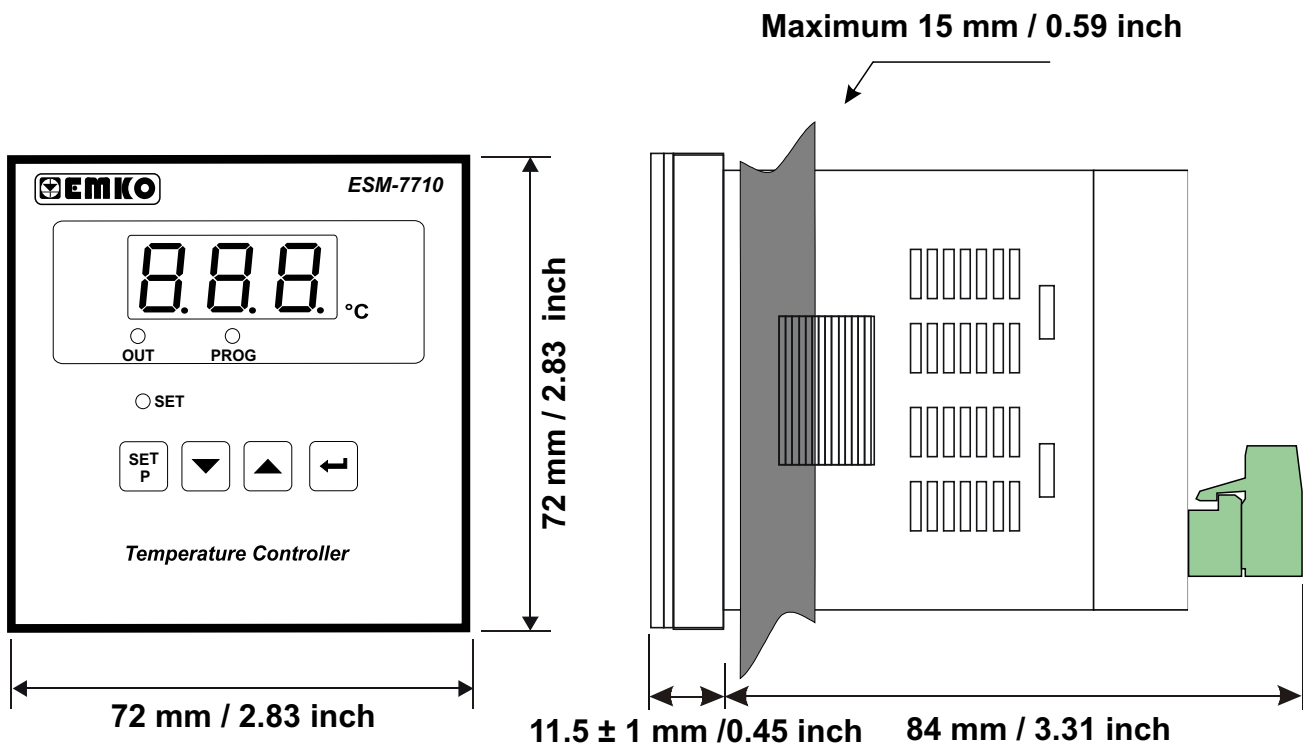

2.3 Front View and Dimensions of ESM-7710 Temperature Controller with Two Relays

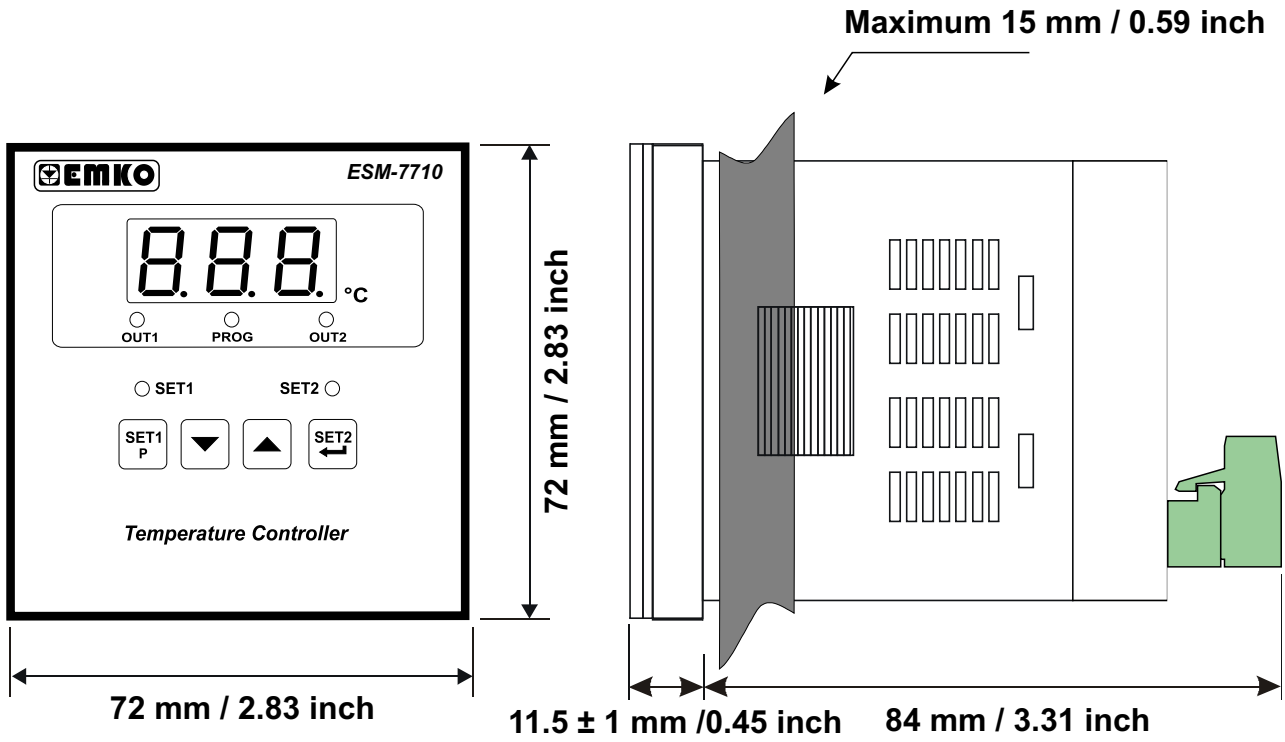

2.4 Panel Cut-Out

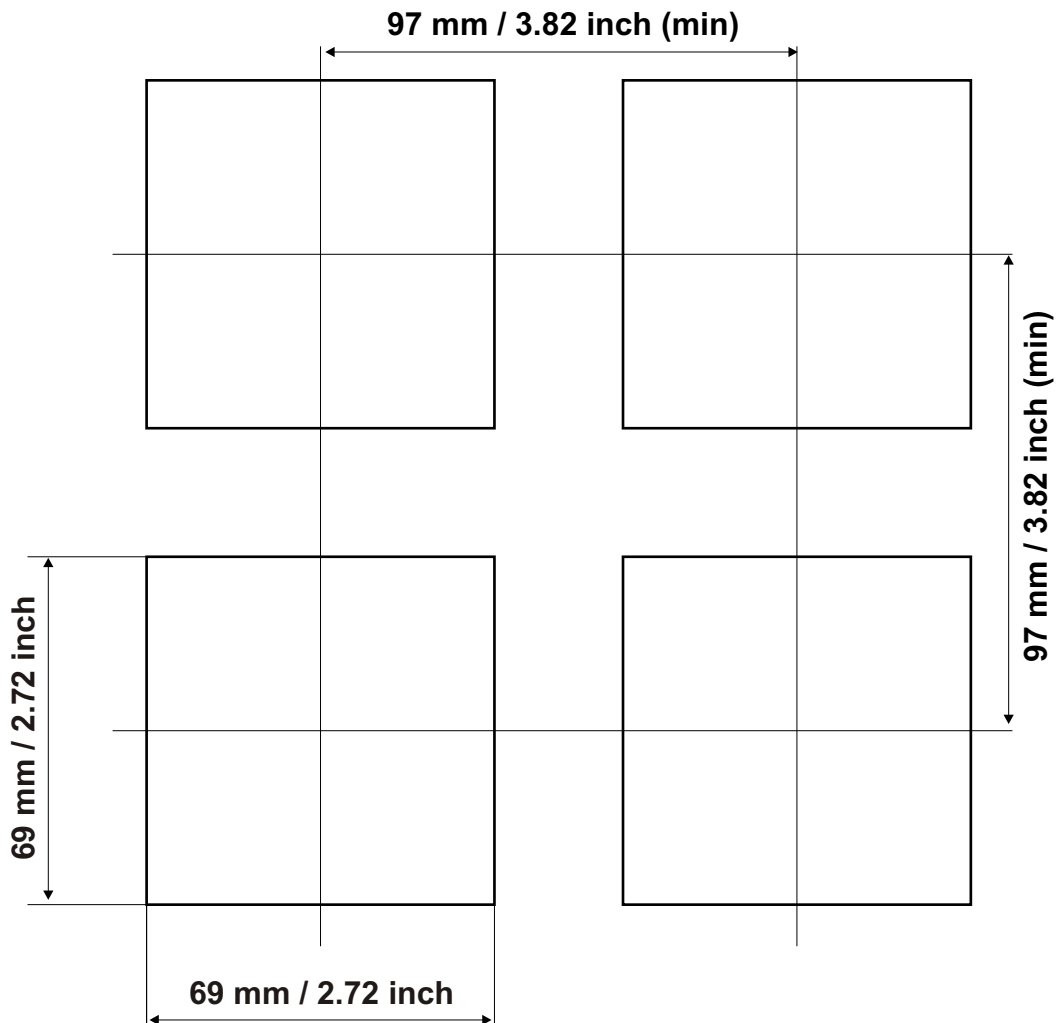

2.5 Environmental Ratings

Operating Conditions



Operating Temperature : 0 to 50 °C



Max. Operating Humidity : 90% Rh (non-condensing)



Altitude : Up to 2000 m.



Forbidden Conditions:

Corrosive atmosphere

Explosive atmosphere

Home applications (The unit is only for industrial applications)

2.6 Panel Mounting

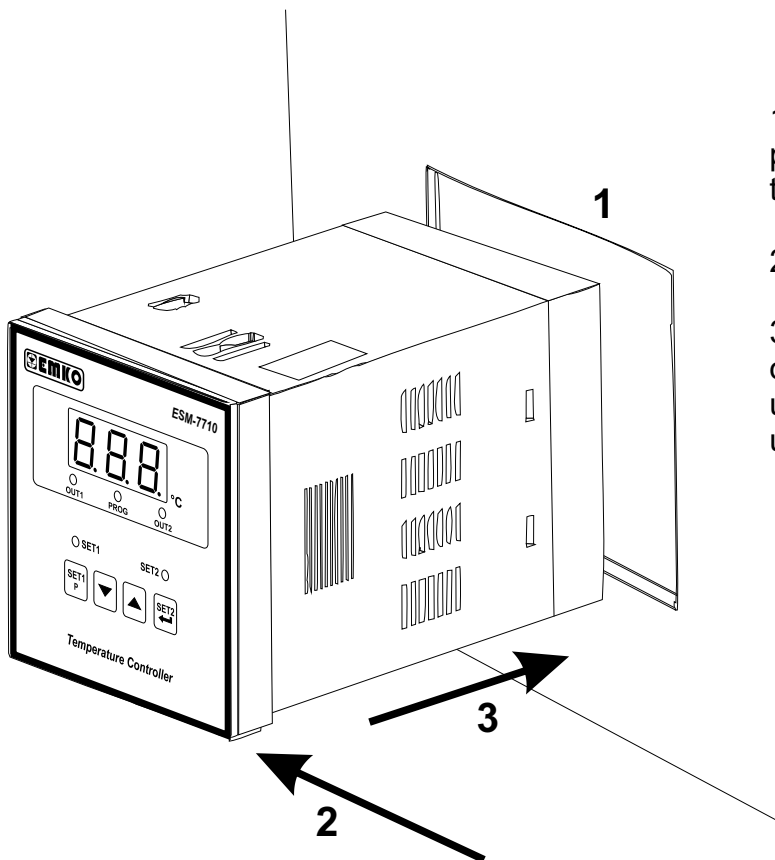

1-Before mounting the device in your panel, make sure that the cut-out is of the right size.

2-Check front panel gasket position

3-Insert the device through the cut-out. If the mounting clamps are on the unit, put out them before inserting the unit to the panel.



During installation into a metal panel, care should be taken to avoid injury from metal burrs which might be present. The equipment can loosen from vibration and become dislodged if installation parts are not properly tightened. These precautions for the safety of the person who does the panel mounting.

2.7 Installation Fixing Clamp

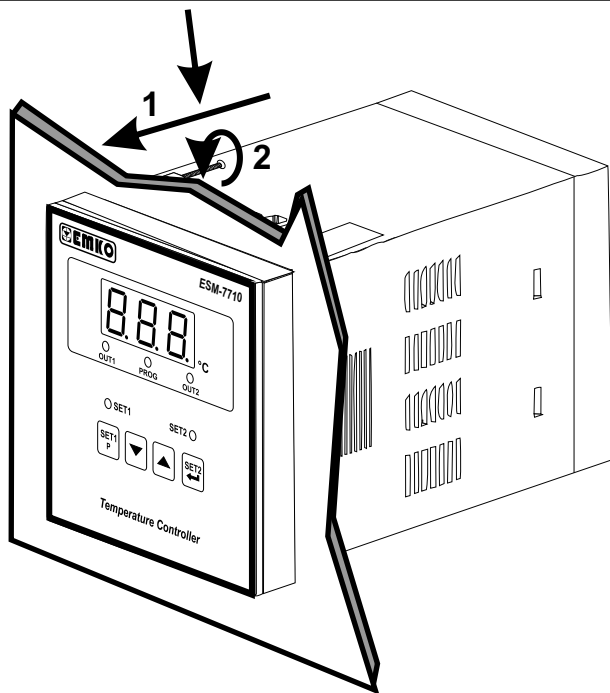

The unit is designed for panel mounting.

1-Insert the unit in the panel cut-out from the front side.

2- Insert the mounting clamps to the holes that located top and bottom sides of device and screw up the fixing screws until the unit completely immobile within the panel



Montage of the unit to a system must be done with it's own fixing clamps. Do not do the montage of the device with inappropriate fixing clamps. Be sure that device will not fall while doing the montage.

2.8 Removing from the Panel



Before starting to remove the unit from panel, power off the unit and the related system.

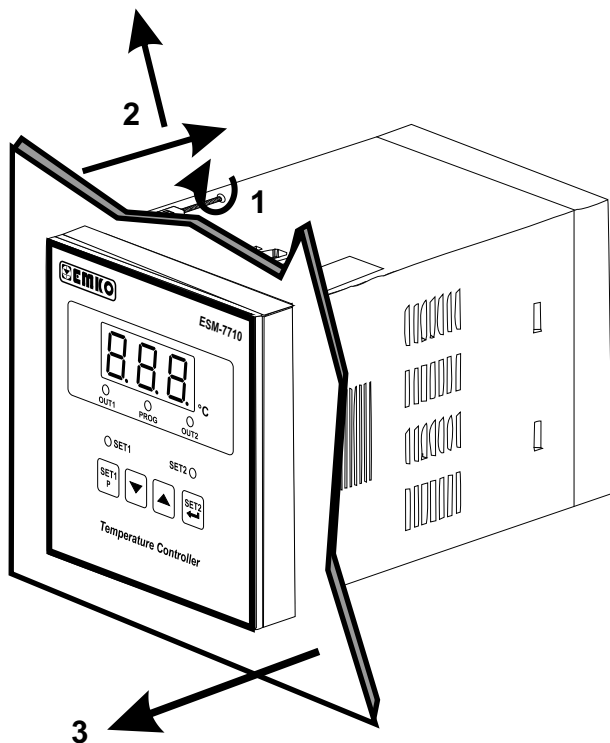

1-Loosen the screws.

2-Pull mounting clamps from top and bottom fixing sockets.

3-Pull the unit through the front side of the panel

3. Electrical Wirings



You must ensure that the device is correctly configured for your application. Incorrect configuration could result in damage to the temperature being controlled, and/or personal injury. It is your responsibility, as the installer, to ensure that the configuration is correct.

Device parameters has factory default values. These parameters must be set according to the system's needs.



Only qualified personnel and technicians should work on this equipment. This equipment contains internal circuits with voltage dangerous to human life. There is severe danger for human life in the case of unauthorized intervention.



Be sure to use the rated power supply voltage to protect the unit against damage and to prevent failure.



Keep the power off until all of the wiring is completed so that electric shock and trouble with the unit can be prevented.

3.1 Terminal Layout and Connection Instructions

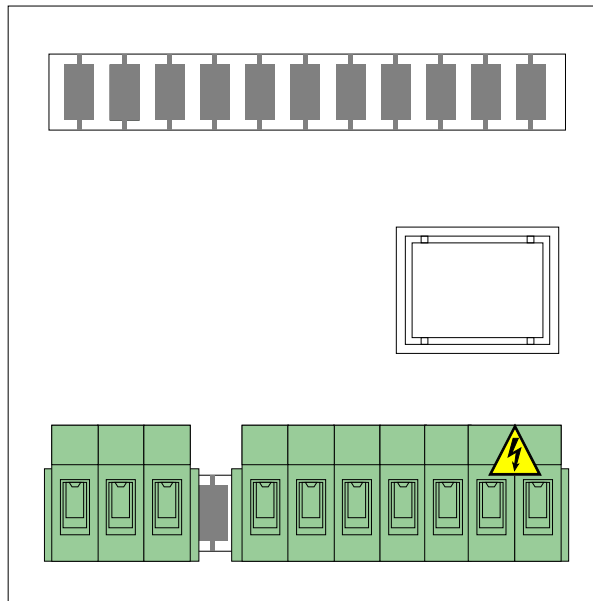

Max. 2.5 mm / 0.098 inch

Wire Size:
14AWG/1 mm²
Solid /Stranded

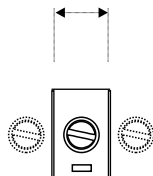

Torque
0.5 Nm



Screw driver
0.8 x 3 mm



3.2 Electrical Wiring Diagram



Electrical wiring of the device must be the same as 'Electrical Wiring Diagram' below to prevent damage to the process being controlled and personnel injury.

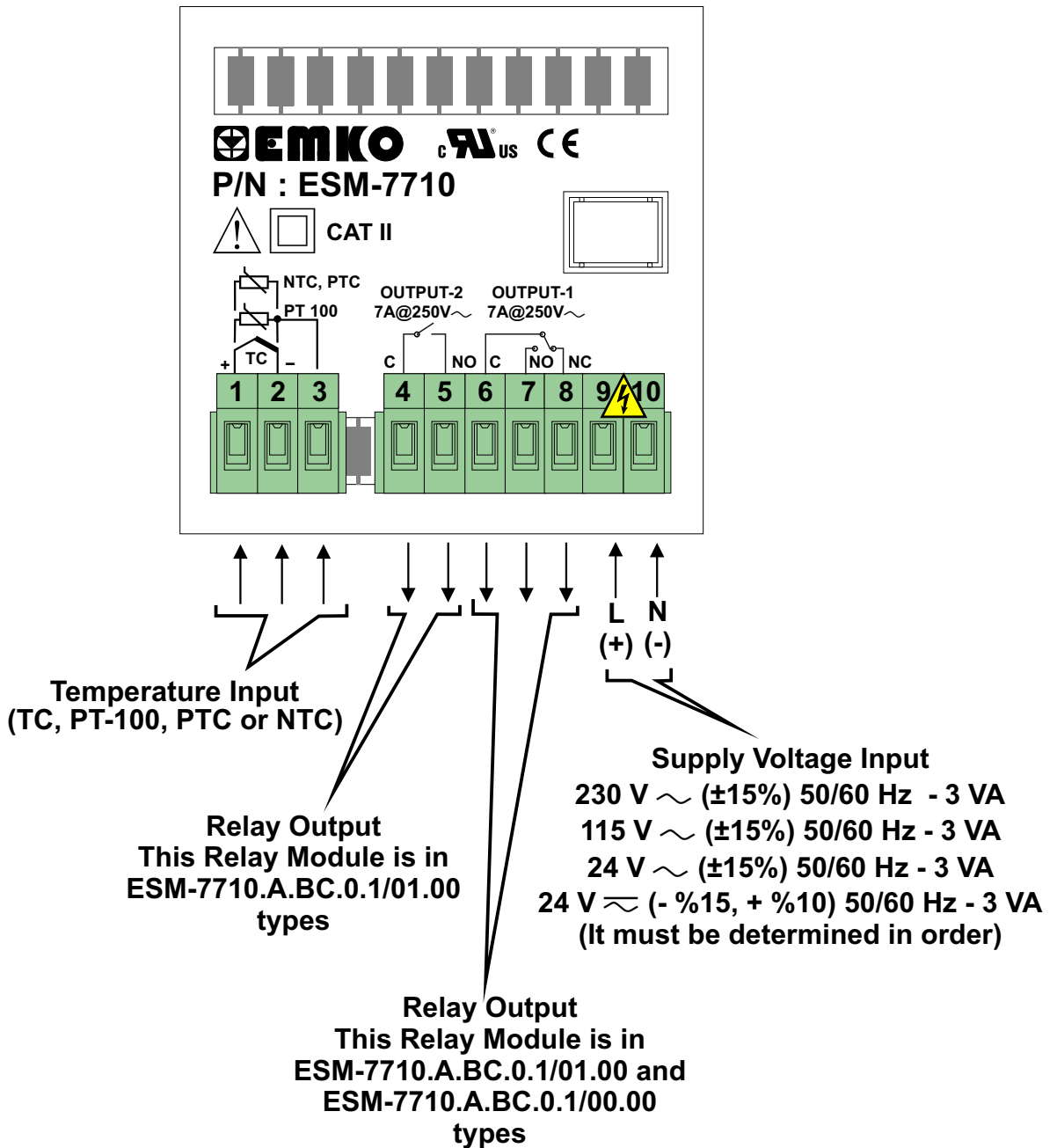

Temperature input is in CAT II class.

3.3 Labels for ESM-7710 Temperature Controller with One Relay

Rear label appearance of the device that have PT-100 (-19.9°C ; + 99.9°C) Scale

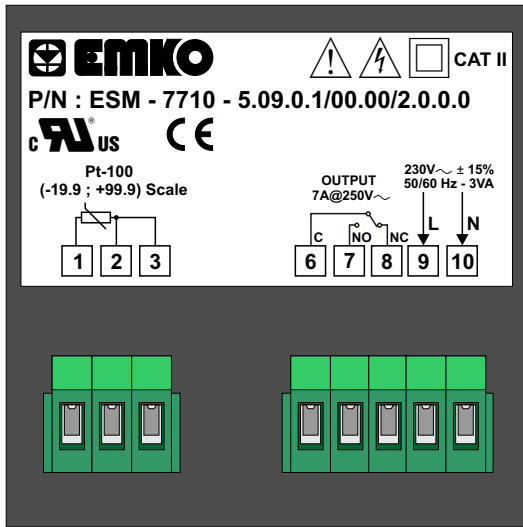

Rear label appearance of the device that have PT-100 (0°C ; 400°C) Scale

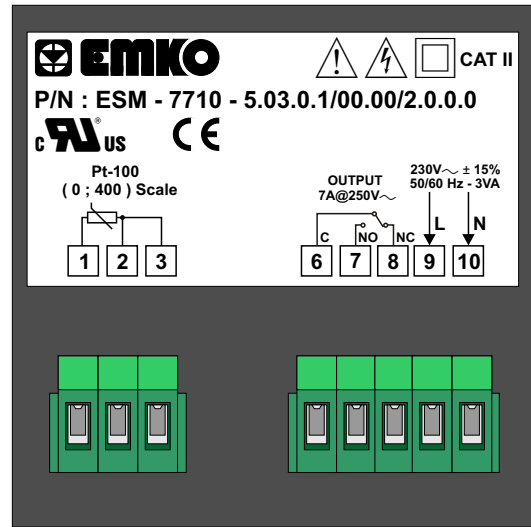

Rear label appearance of the device that have PTC (-19.9°C ; + 99.9°C) Scale

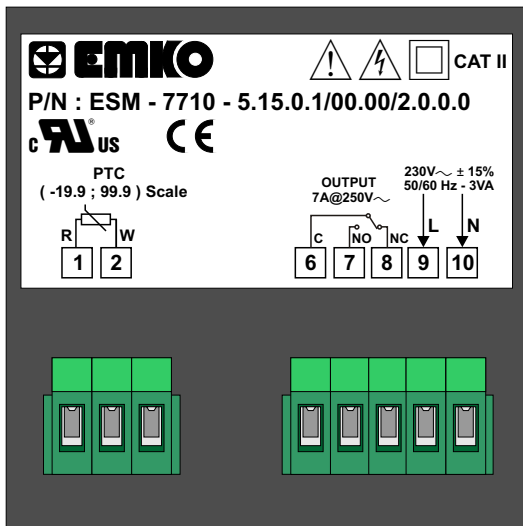

Rear label appearance of the device that have PTC (-50°C ; 150°C) Scale

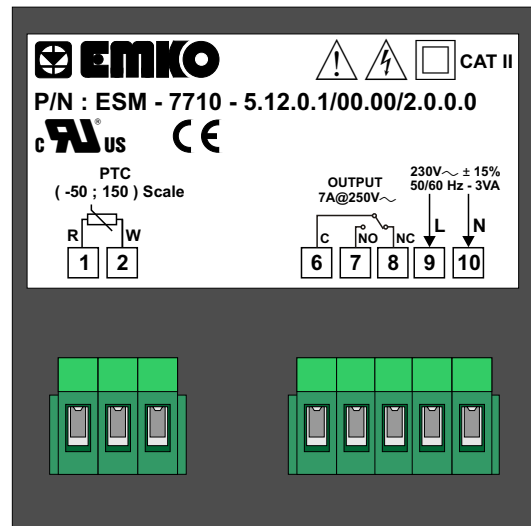

Rear label appearance of the device that have J Type Thermocouple (0°C ; 800°C) Scale

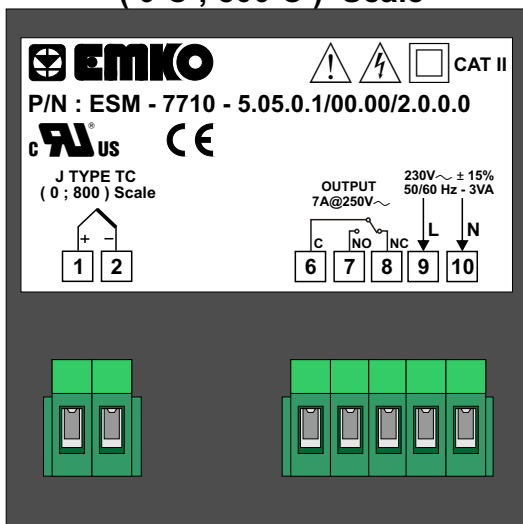

Rear label appearance of the device that have K Type Thermocouple (0°C ; 999°C) Scale

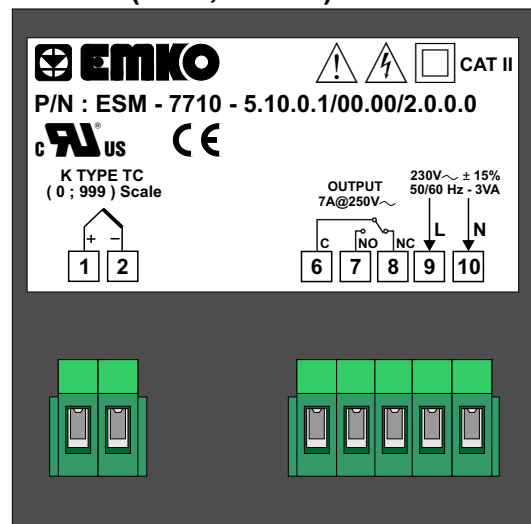

3.4 Labels for ESM-7710 Temperature Controller with Two Relays

Rear label appearance of the device that have PT-100 (-19.9°C ; + 99.9°C) Scale

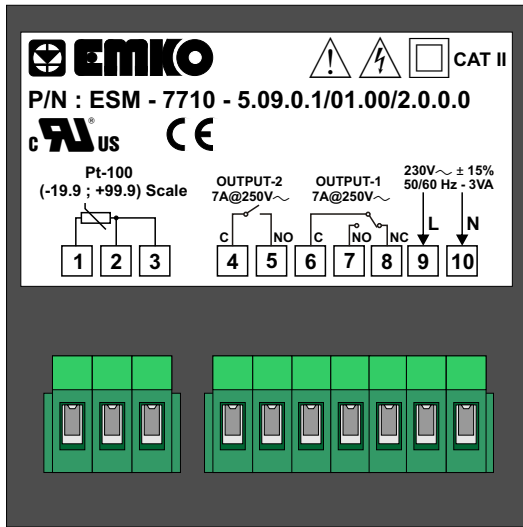

Rear label appearance of the device that have PT-100 (0°C ; 400°C) Scale

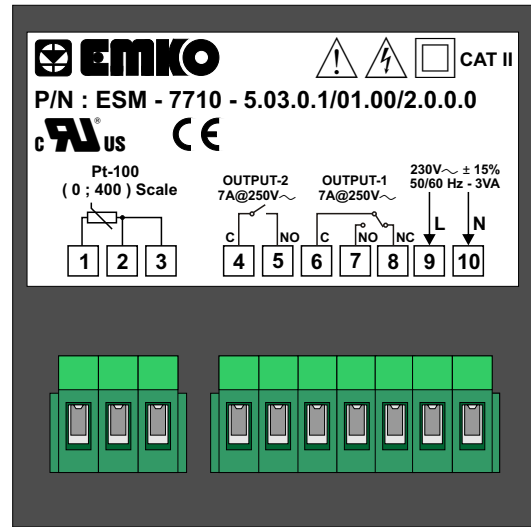

Rear label appearance of the device that have PTC(-19.9°C ; + 99.9°C) Scale

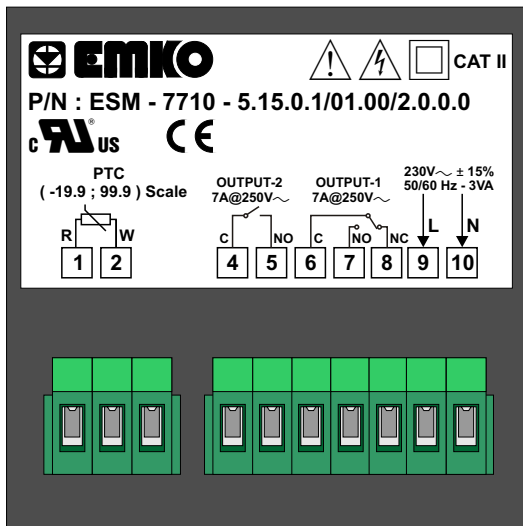

Rear label appearance of the device that have PTC (-50°C ; 150°C) Scale

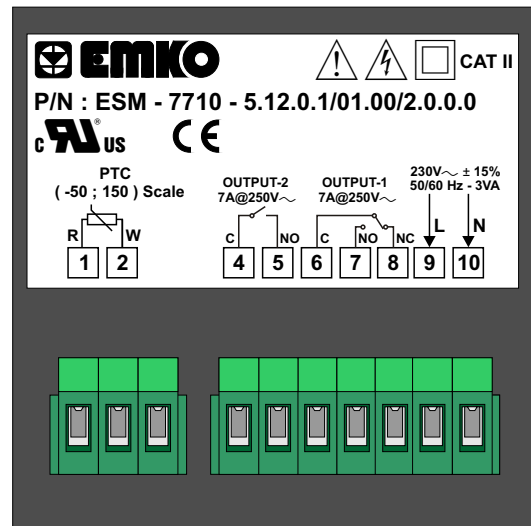

Rear label appearance of the device that have J Type Thermocouple (0°C ; 800°C) Scale

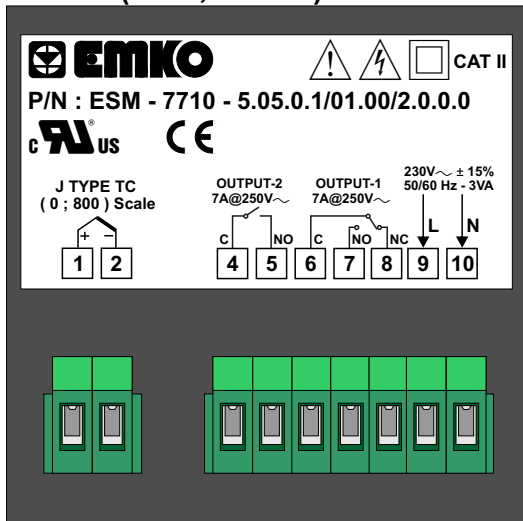

Rear label appearance of the device that have K Type Thermocouple (0°C ; 999°C) Scale

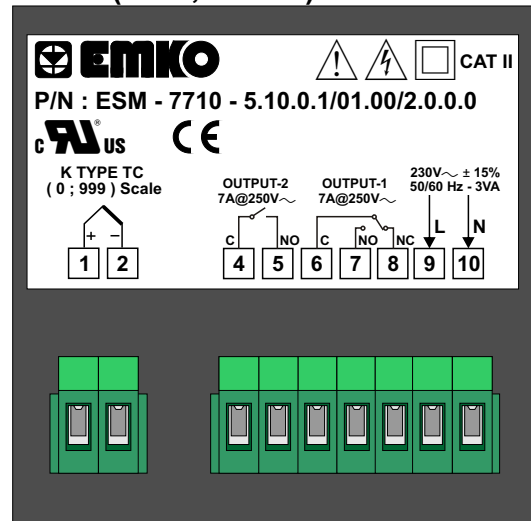

3.5 Supply Voltage Input Connection of the Device

Connection of Supply Voltage Input

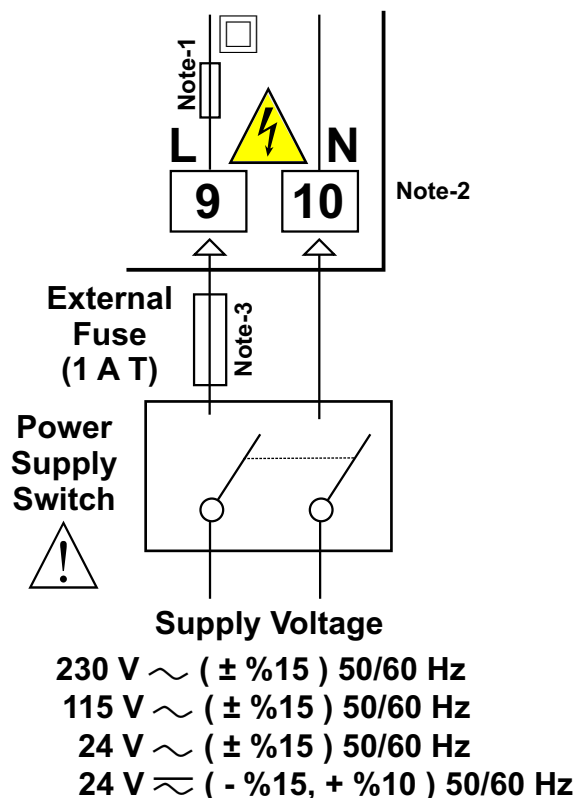

- Note-1 :** There is an internal 33R Ω fusible flameproof resistor in 100-240 V \sim 50/60Hz
 There is an internal 4R7 Ω fusible flameproof resistor in 24V \sim 50/60Hz and 24V \approx 50/60Hz
Note-2 : “L” is (+), “N” is (-) for 24V \approx Supply voltage
Note-3 : External fuse is recommended.



Make sure that the power supply voltage is the same indicated on the instrument.
Switch on the power supply only after that all the electrical connections have been completed.
Supply voltage range must be determined in order. While installing the unit, supply voltage range must be controlled and appropriate supply voltage must be applied to the unit. Controlling prevents damages in unit and system and possible accidents as a result of incorrect supply voltage.



There is no power supply switch on the device. So a power supply switch must be added to the supply voltage input. In accordance with the safety regulations, the power supply switch shall bring the identification of the relevant instrument. Power supply switch shall be easily accessible by the user.
Power switch must be two poled for seperating phase and neutral. On/Off condition of power switch is very important in electrical connection. On/Off condition of power switch must be signed for preventing the wrong connection.

If an external fuse is used, it must be on phase connection in \sim supply input.
If an external fuse is used, it must be on (+) line connection in \approx supply input.



The instrument is protected with an internal fuse (Please refer to Note-1 for information). In case of failure it is suggested to return the instrument to the manufacturer for repair.

3.6 Temperature Input Connection

3.6.1 TC (Thermocouple) Connection

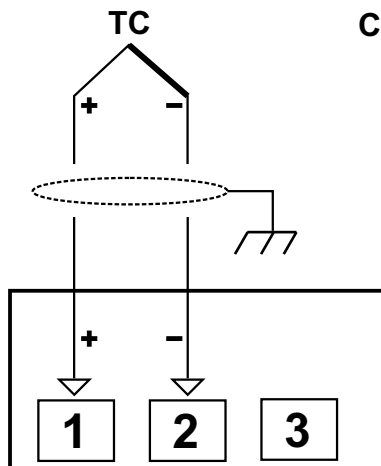

Connect the wires with the polarity as shown in the figure at left.



Always use compensation wire corresponding to the thermocouple used. If present, the shield must be connected to a proper ground.



Input resistance is greater than 10 M Ω .

3.6.2 RTD Connections

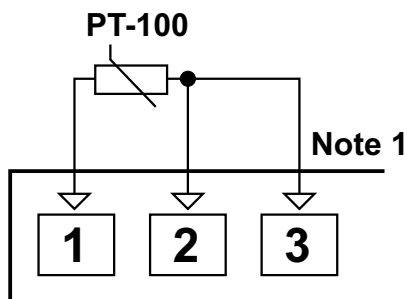

3-wire PT-100 connection
(with line compensation)
(Max. Line impedance is 10 Ω)

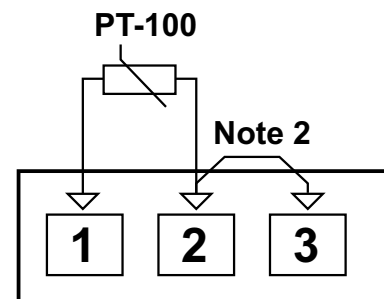

2-wire PT-100 connection
(without line compensation)

Note 1 : In 3-wire system, use always cables of the same diameter (min 1mm²) Its necessary to use cable in the same gauge and type for doing the line compensation properly.

Note 2 : Install a jumper between terminals 2 and 3 when using a 2-wire RTD.

Note 3 : If the distance is longer than 10 meters, use 3-wire system.



Input resistance is greater than 10 M Ω .

3.6.3 PTC and NTC Connections

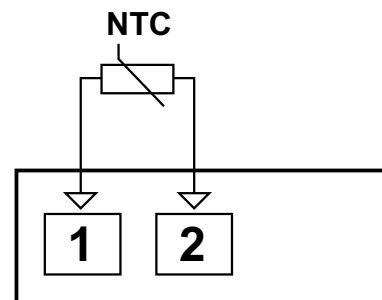
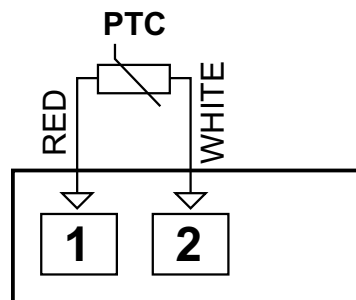

Input resistance is greater than 10 M Ω .



While doing the PTC Probe connection, pay attention to the PTC Probe cable colour.

3.7 Galvanic Isolation Test Values of ESM-7710 Temperature Controller

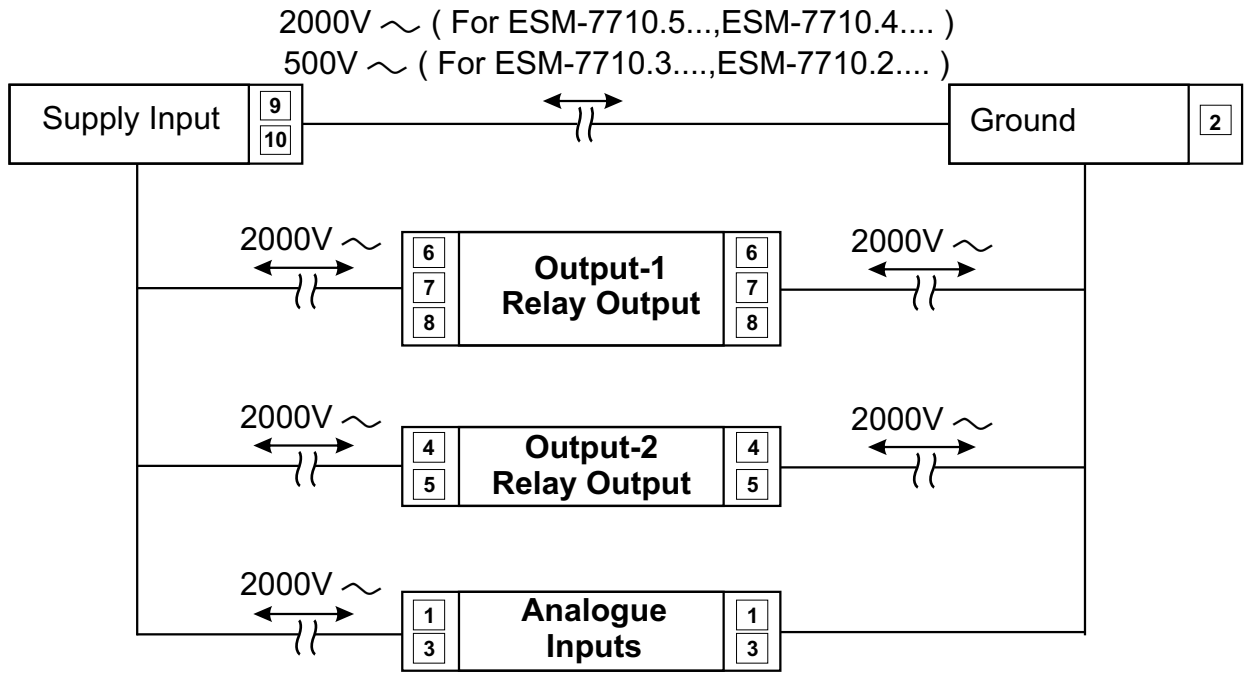

3.8 Output-1 Connection

3.8.1 Output-1 (Relay Output) Connection

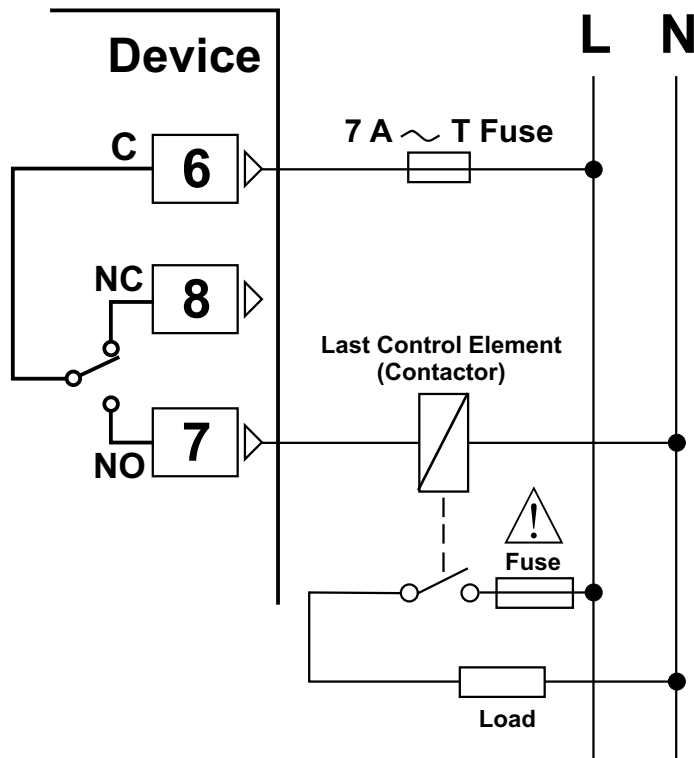

Fuses must be selected according to the application

3.8.2 SSR Driver Output-1 Connection

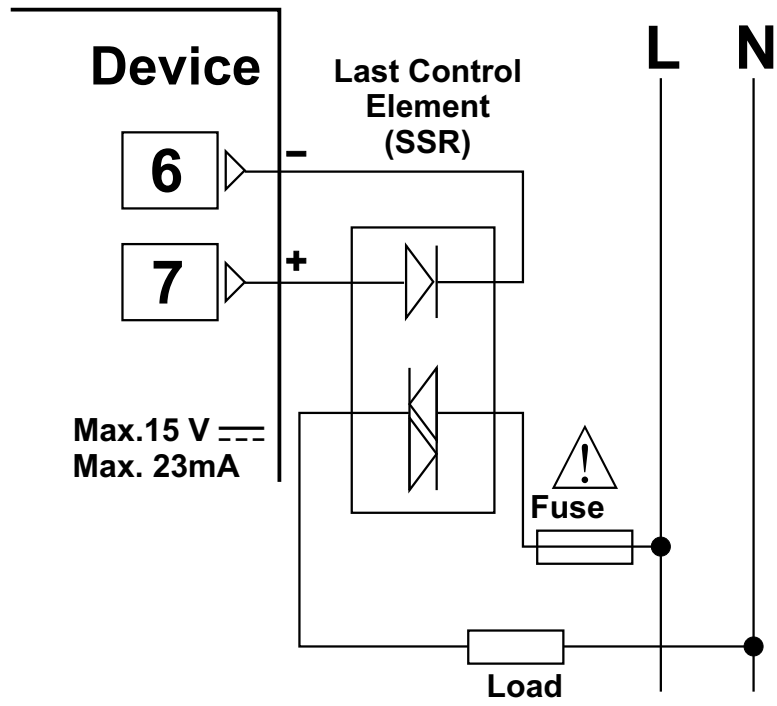

3.9 Output-2 Connections

3.9.1 Output-2 (Relay Output) Connection

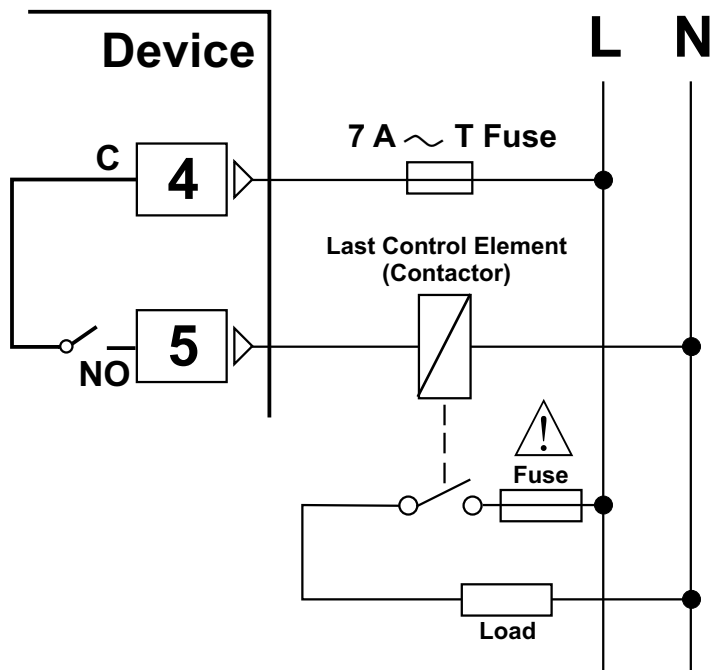

Fuses must be selected according to the application



Output-2 exists in device with two relays

3.9.2 SSR Driver Output-2 Connection

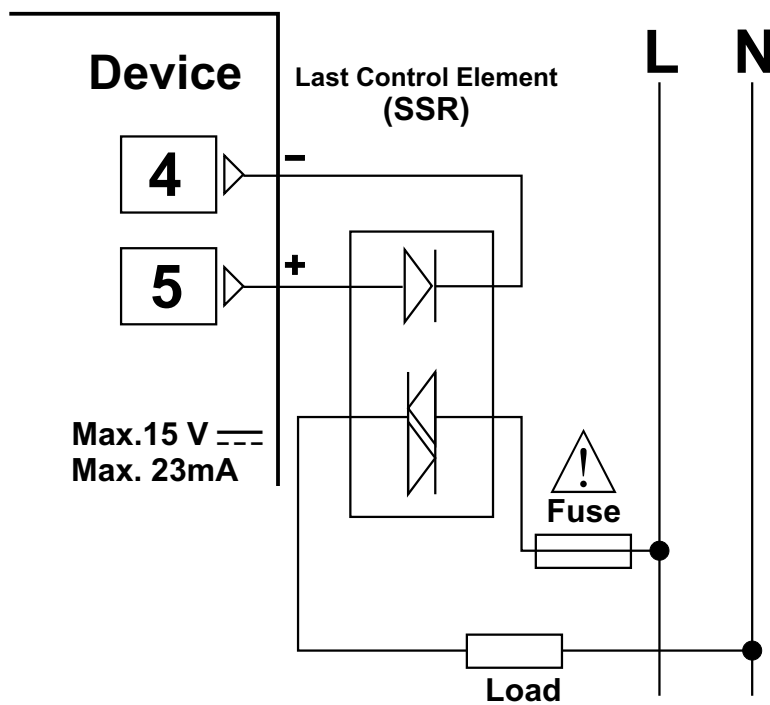

4. Front Panel Definition and Accessing to the Menu

4.1 Front Panel Definition for ESM-7710 with One Relay

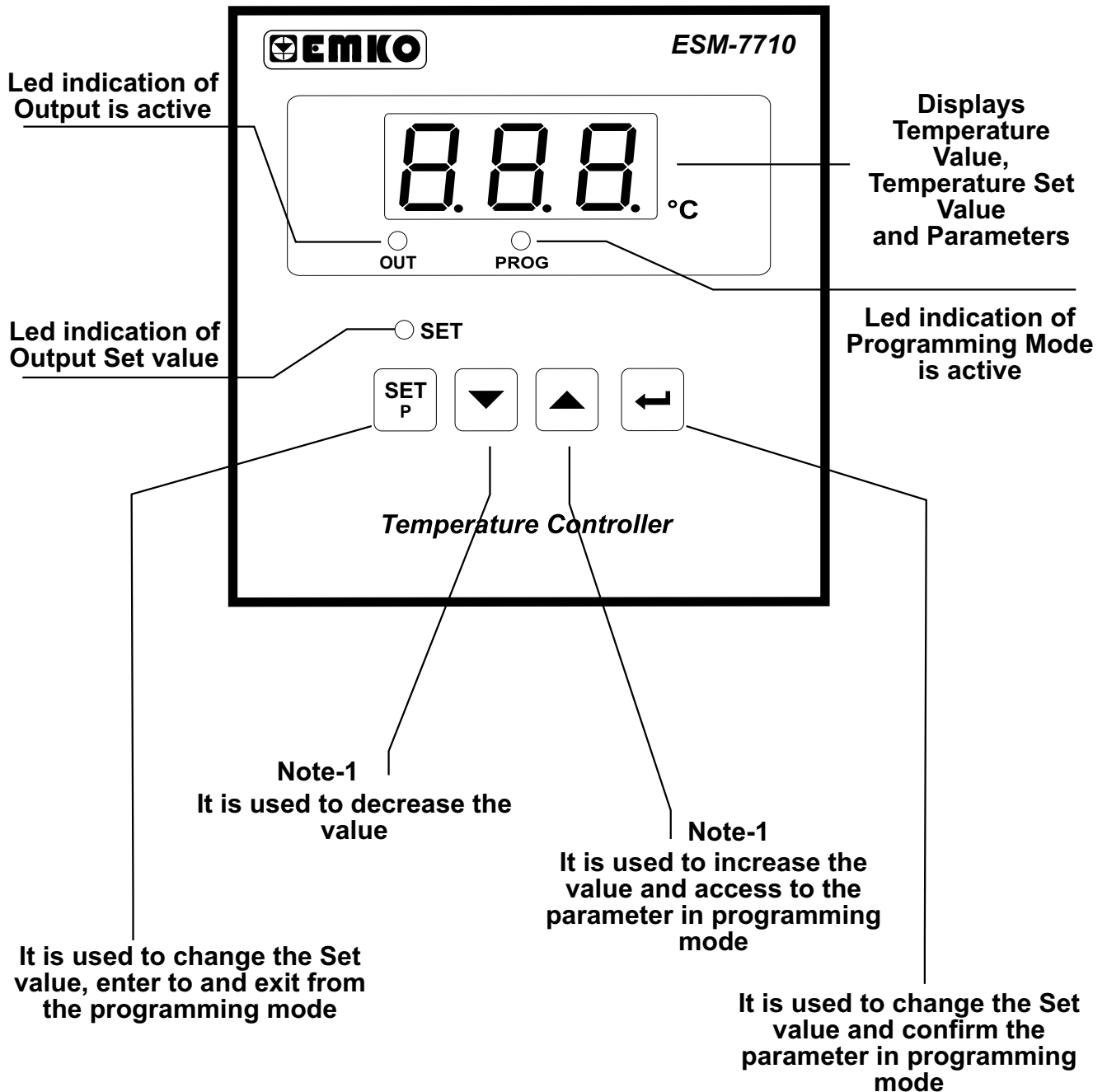

Note-1: In Set value or programming mode while changing the parameter, if increment or decrement button is pressed for 5 seconds continuously, increment and decrement number become 10, if increment or decrement button is pressed for 10 seconds continuously, increment and decrement number become 100.

4.2 Front Panel Definition for ESM-7710 with Two Relays

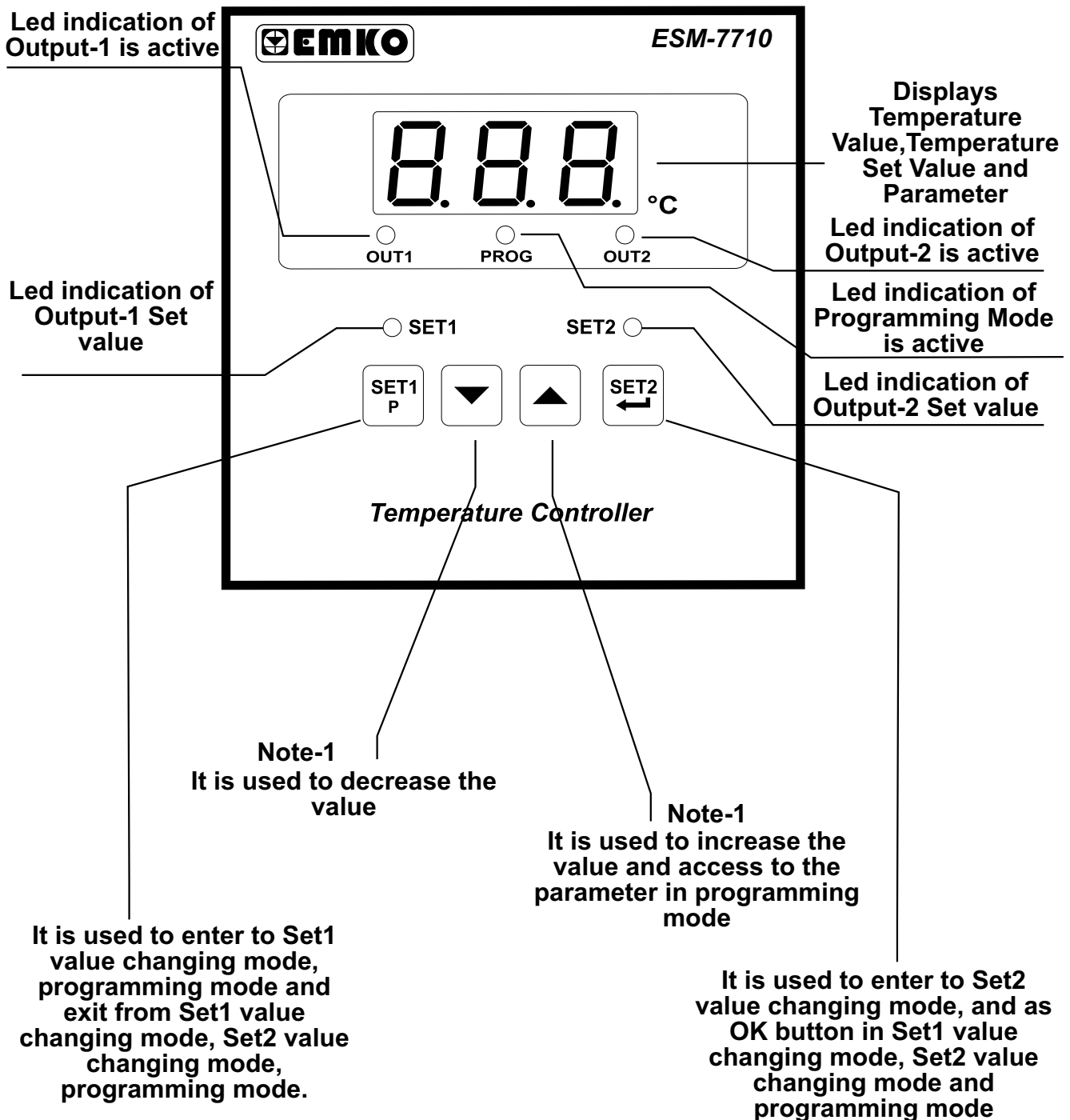

Note-1: In Set value or programming mode while changing the parameter, if increment or decrement button is pressed for 5 seconds continuously, increment and decrement number become 10, if increment or decrement button is pressed for 10 seconds continuously, increment and decrement number become 100.

4.3 Observation of ESM-7710 Temperature Controller Software Revision

When the power is applied to the device, software revision number is momentarily shown on the display.

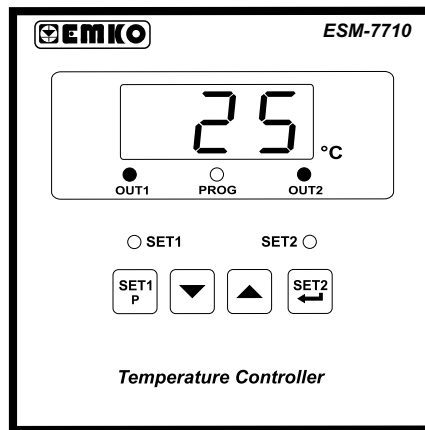
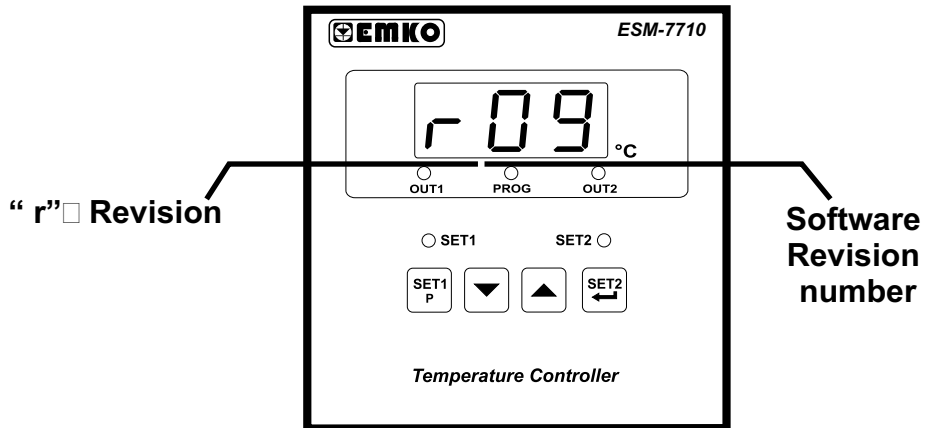

Main operation screen is shown



If there is an unexpected situation while opening the device, power off the device and inform a qualified personnel.

4.4 Changing and Saving Set Values

4.4.1 ESM-7710 with One Relay

Main Operation Screen



When SET button is pressed, SET led lights on and SET value is observed on display.

○ SET



SET Value Screen



● SET



SET value can be changed with increment and decrement buttons.

SET Value Screen



● SET



Press SET button again to exit without saving SET value.

Press Enter button for saving SET value.

Main Operation Screen



For both conditions, SET led lights off and it turns to main operation screen.

○ SET



If no operation is done in programming or Set value mode for 20 seconds, device turns to main operation screen automatically.

Adjustment of SET1 value

Main Operation Screen

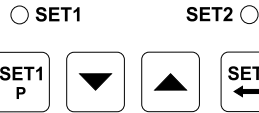
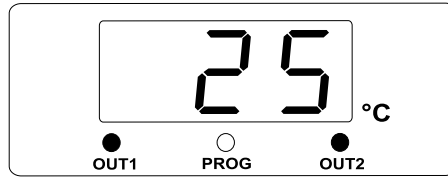

When SET1 button is pressed, SET1 led lights on and SET1 value is seen on display.

SET1 Value Screen

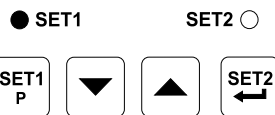
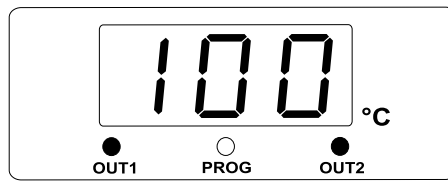

SET1 value can be changed with increment and decrement buttons.

SET1 Value Screen

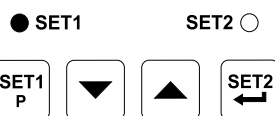

Press SET2/Enter button for saving SET1 value.

Press SET1 button again to exit without saving SET1 value.

Main Operation Screen

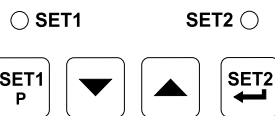

For both conditions SET1 led lights off and it turns to main operation screen.



If no operation is done in programming or Set value mode for 20 seconds, device turns to main operation screen automatically.

Adjustment of SET2 value

Main Operation Screen



○ SET1 SET2 ○

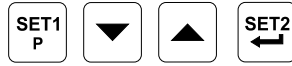

When SET2 button is pressed, SET2 led lights on and SET2 value is seen on display.

SET2 Value Screen



○ SET1 SET2 ●



SET2 value can be changed with increment and decrement buttons.

SET2 Value Screen



○ SET1 SET2 ●



Press SET1 button to exit without saving SET2 value.

Press SET2/Enter button for saving SET2 value.

Main Operation Screen



○ SET1 SET2 ○

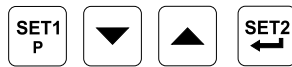

For both conditions, SET2 led lights off and it turns to main operation screen.



If no operation is done in programming or Set value mode for 20 seconds, device turns to main operation screen automatically.

4.5 Entering to Programming Mode, Changing and Saving Parameters

4.5.1 ESM-7710 with One Relay

Main Operation Screen

When SET button is pressed for 10 seconds, "PROG" led starts to blink. If programming mode entering password is different from 0, programming mode entering screen **PrG** will be observed



Note: If programming mode accessing password is 0, hysteresis screen **H51** is observed instead of **PrG** programming screen accessing password

Programming Mode Entering Screen

In programming mode entering screen, press SET button to exit from programming mode and turn to the main operation screen.



Press increment button for accessing to the password entering screen

Parameters can be observed by pressing Enter button, but parameters can not be changed.

Password Entering Screen

In password entering screen, press SET button to return the programming mode entering screen

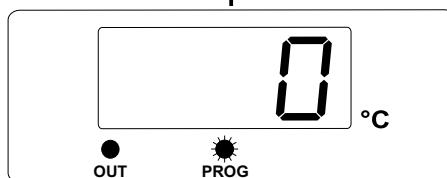

Enter programming mode accessing password with increment and decrement buttons

Parameters can be observed by pressing Enter button, but parameters can not be changed.

Programming Mode Entering Screen



Press SET button to exit programming mode.



Password Entering Screen

In password entering screen, press SET button to return the programming mode entering screen

Press Enter button for accessing to the parameters



Main Operation Screen



If no operation is done in programming or Set value mode for 20 seconds, device turns to main operation screen automatically.

Programming Screen

In programming screen, Press SET1 button to exit from programming mode and turn to the main operation screen.

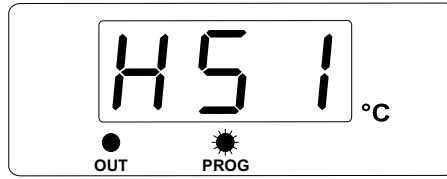

Hysteresis Parameter

Parameter value can be observed by pressing increment button.

If Enter button is pressed next parameter is shown.

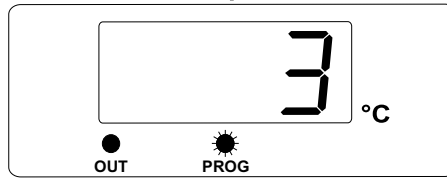

Hysteresis Value

If Enter button is pressed next parameter is shown.

Parameter can be changed with increment and decrement buttons.

In programming screen, Press SET button to exit from programming mode and turn to the main operation screen.

Programming Screen



Hysteresis Value

Press SET button to exit from programming mode.

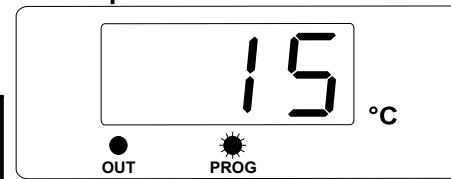
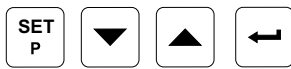

Press SET button to turn to the programming screen without saving the parameter.

Press Enter button for saving parameter value.



Main Operation Screen



If no operation is done in programming or Set value mode for 20 seconds, device turns to main operation screen automatically.

Programming Screen

In programming screen, Press SET1 button to exit from programming mode and turn to the main operation screen.

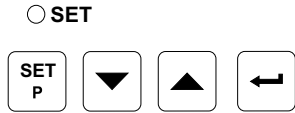
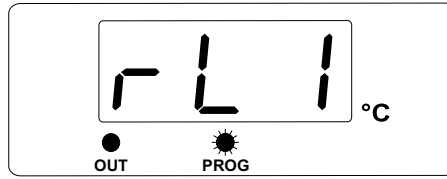

Operation Type Selection for Output

Parameter value can be observed by pressing increment button.

If Enter button is pressed next parameter is shown.

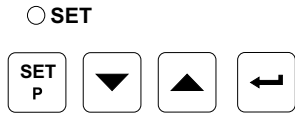
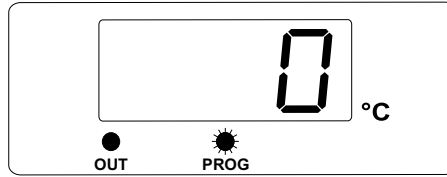

Value of Operation Type Selection for Output

Heating is selected

If Enter button is pressed next parameter is shown.

Parameter can be changed with increment and decrement buttons.

In programming screen, Press SET button to exit from programming mode and turn to the main operation screen.

Programming Screen

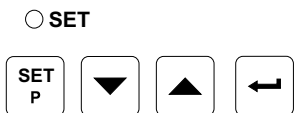
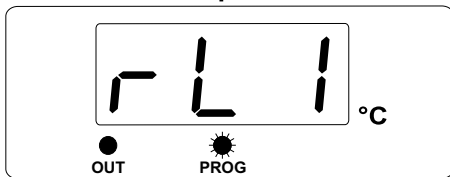

Press SET button to exit from programming mode.

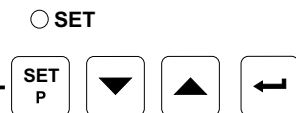
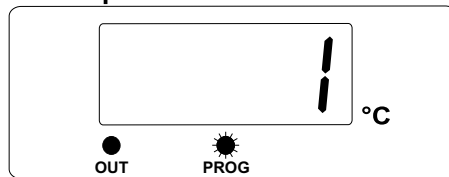

Value of Operation Type Selection for Output

It is changed as cooling

Press Enter button for saving parameter value.

Press SET button to turn to the programming screen without saving the parameter.

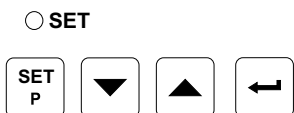

Main Operation Screen



If no operation is done in programming or Set value mode for 20 seconds, device turns to main operation screen automatically.

Programming Screen

In programming screen, Press SET1 button to exit from programming mode and turn to the main operation screen.

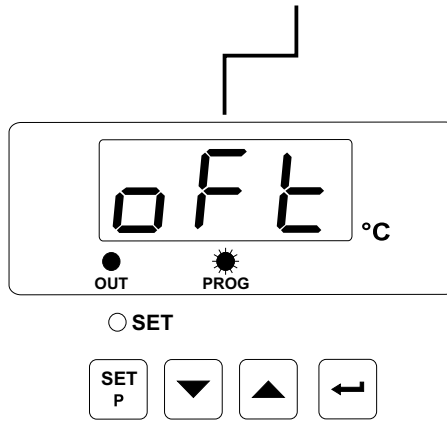

Process Offset Parameter

Parameter value can be observed by pressing increment button.

If Enter button is pressed, next parameter is shown.

Press SET button to turn to the programming screen without saving the parameter.

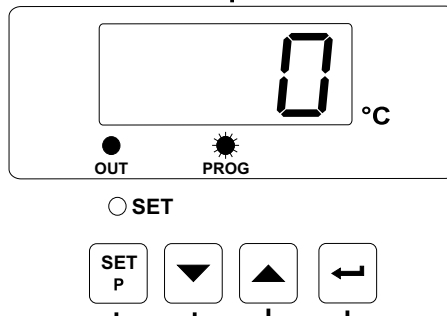

Process Offset Value

If Enter button is pressed, next parameter is shown.

Parameter can be changed with increment and decrement buttons.

Programming Screen

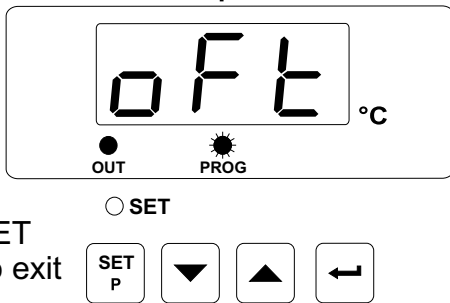

Press SET button to exit from programming mode.

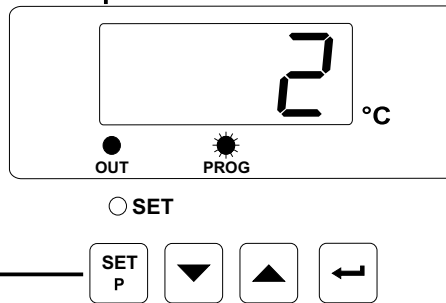

Process Offset Value

Press SET button to turn to the programming screen without saving the parameter.

Press Enter button for saving parameter value.

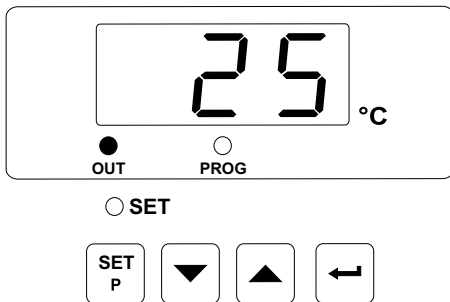

Main Operation Screen



If no operation is done in programming or Set value mode for 20 seconds, device turns to main operation screen automatically.

Programming Screen

In programming screen, Press SET1 button to exit from programming mode and turn to the main operation screen.

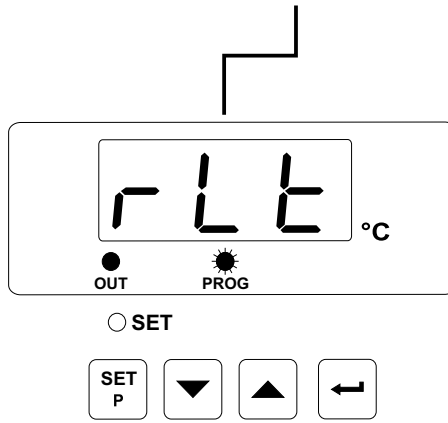

Minimum Pulling Time for Output Parameter

Parameter value can be observed by pressing increment button.

If Enter button is pressed, next parameter is shown.

Press SET button to turn to the programming screen without saving the parameter.

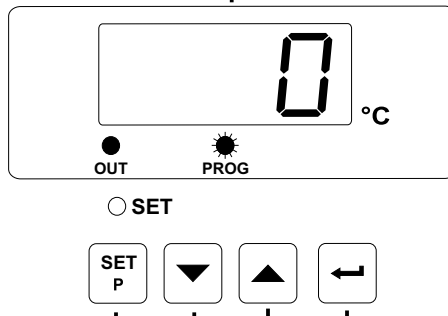

Value of Minimum Pulling Time for Output

If Enter button is pressed, next parameter is shown.

Parameter can be changed with increment and decrement buttons.

Programming Screen

Press SET button to exit from programming mode.

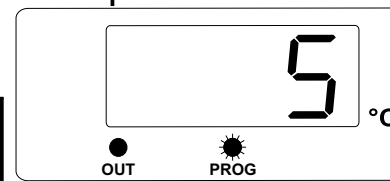

Value of Minimum Pulling Time for Output

Press SET button to turn to the programming screen without saving the parameter.

Press Enter button for saving parameter value.



Main Operation Screen



If no operation is done in programming or Set value mode for 20 seconds, device turns to main operation screen automatically.

Programming Screen

In programming screen, Press SET1 button to exit from programming mode and turn to the main operation screen.

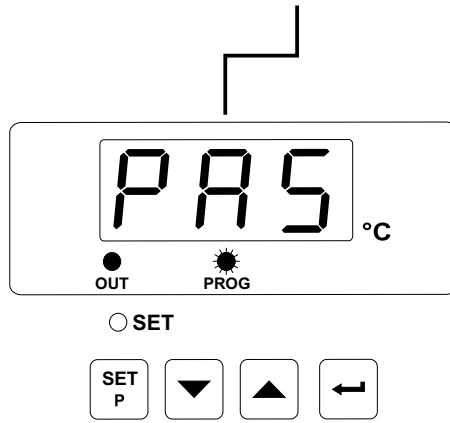

Programming Mode Accessing Password

Parameter value can be observed by pressing increment button.

If Enter button is pressed, next parameter is shown.

Press SET button to turn to the programming screen without saving the parameter.

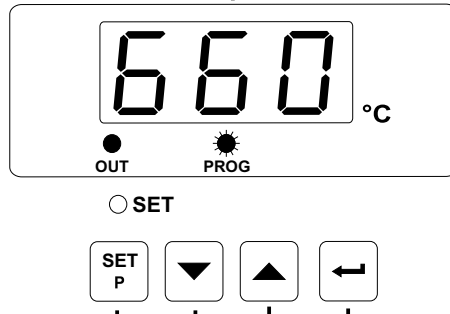

Programming Mode Accessing Password Value

If Enter button is pressed, next parameter is shown.

Parameter can be changed with increment and decrement buttons.

Programming Screen

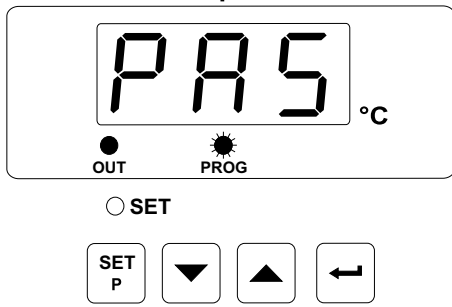

Programming Mode Accessing Password Value

Press Enter button for saving parameter value.

Press SET button to exit from programming mode.

Press SET button to turn to the programming screen without saving the parameter.

Programming Screen

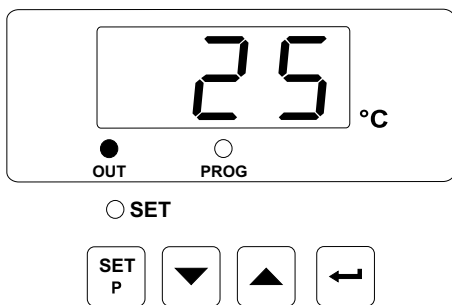

Main Operation Screen

Press SET button to exit from programming section

Continue to press SET2/Enter button for accessing to the parameters.

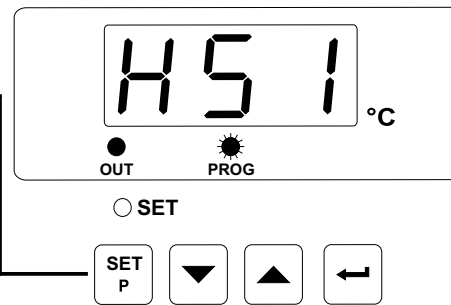

Hysteresis Parameter

It turns to beginning of the programming mode



If no operation is done in programming or Set value mode for 20 seconds, device turns to main operation screen automatically.

4.5.2 ESM-7710 with Two Relays

Main Operation Screen

When SET1 button is pressed for 10 seconds, "PROG" led starts to blink. If programming mode entering password is different from 0, programming mode entering screen **Pr0** will be observed

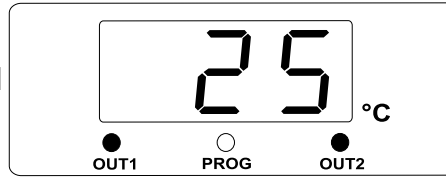

Note: If programming mode accessing password is 0, hysteresis screen **H51** is observed instead of **Pr0** programming screen accessing password

Programming Mode Entering Screen

In programming mode entering screen, press SET1 button to exit from programming mode and turn to the main operation screen.

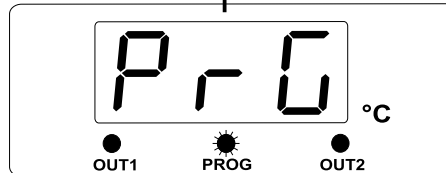

Press increment button for accessing to the password entering screen

Parameters can be observed by pressing SET2/Enter button, but parameters can not be changed.

Password Entering Screen

In password entering screen, press SET1 button to return the programming mode entering screen

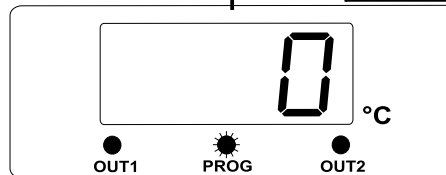

Enter programming mode accessing password with increment and decrement buttons

Parameters can be observed by pressing SET2/Enter button, but parameters can not be changed.

Programming Mode Entering Screen

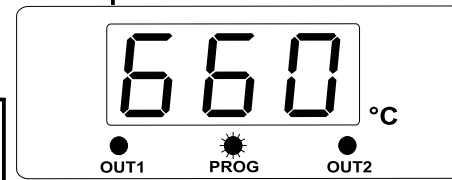

Password Entering Screen

Press SET1 button to exit programming mode.



Main Operation Screen

In password entering screen, press SET1 button to return the programming mode entering screen

Press SET2/Enter button for accessing to the parameters



If no operation is done in programming or Set value mode for 20 seconds, device turns to main operation screen automatically.

Programming Screen

In programming screen, Press SET1 button to exit from programming mode and turn to the main operation screen.



Hysteresis-1 Parameter

Parameter value can be observed by pressing increment button.

If SET2/Enter button is pressed, next parameter is shown.

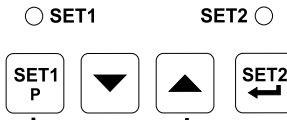

Hysteresis-1 Value

If SET2/Enter button is pressed, next parameter is shown.

Parameter can be changed with increment and decrement buttons.

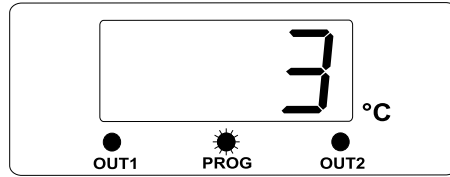

Press SET1 button to exit without saving parameter value.

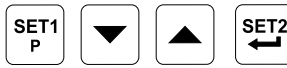

Programming Screen

Hysteresis-1 Value

Press SET1 button to exit from programming mode.

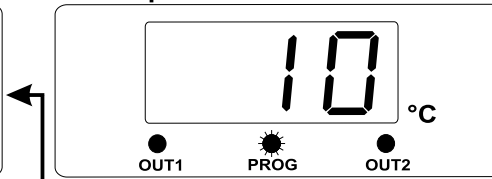

In programming screen, Press SET1 button to exit from programming mode and turn to the operation screen.

Press SET2/Enter button for saving parameter value.



Main Operation Screen



If no operation is done in programming or Set value mode for 20 seconds, device turns to main operation screen automatically.

Programming Screen

In programming screen, Press SET1 button to exit from programming mode and turn to the main operation screen.



Hysteresis-2 Parameter

Parameter value can be observed by pressing increment button.

If SET2/Enter button is pressed, next parameter is shown.

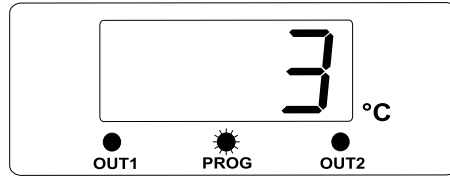
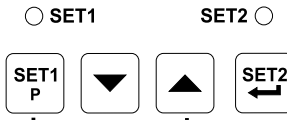

Hysteresis-2 Value

If SET2/Enter button is pressed, next parameter is shown.

Parameter can be changed with increment and decrement buttons.

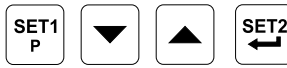

Press SET1 button to exit without saving parameter value.

Programming Screen



Press SET1 button to exit from programming mode.

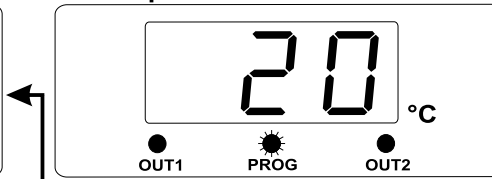

Hysteresis-2 Value

In programming screen, Press SET1 button to exit from programming mode and turn to the operation screen.

Press SET2/Enter button for saving parameter value.



Main Operation Screen

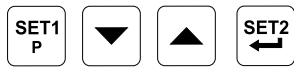

If no operation is done in programming or Set value mode for 20 seconds, device turns to main operation screen automatically.

Programming Screen

In programming screen, Press SET1 button to exit from programming mode and turn to the main operation screen.

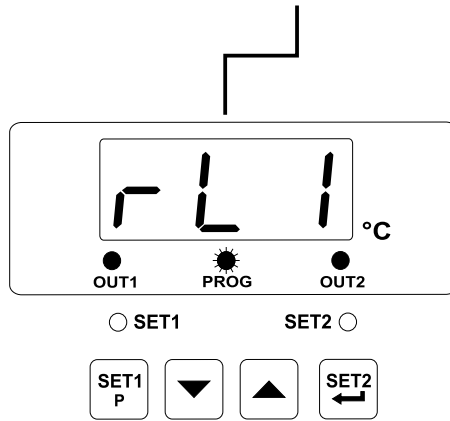

Operation Type Selection for Output-1

Parameter value can be observed by pressing increment button.

If SET2/Enter button is pressed, next parameter is shown.

Value of Operation Type Selection for Output-1

Heating is selected

If SET2/Enter button is pressed, next parameter is shown.

Parameter can be changed with increment and decrement buttons.

In programming screen, Press SET1 button to exit from programming mode and turn to the operation screen.

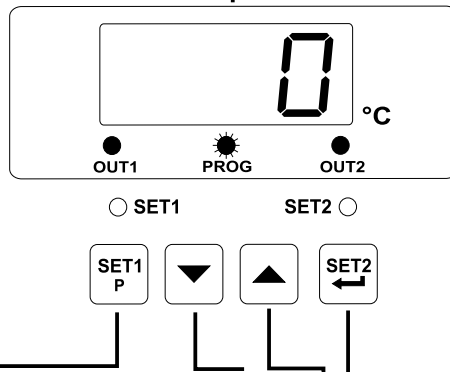

Programming Screen

Value of Operation Type Selection for Output-1

Cooling is selected

Press SET2/Enter button for saving parameter value.

Press SET1 button to exit from programming mode.

In programming screen, Press SET1 button to exit from programming mode and turn to the operation screen.

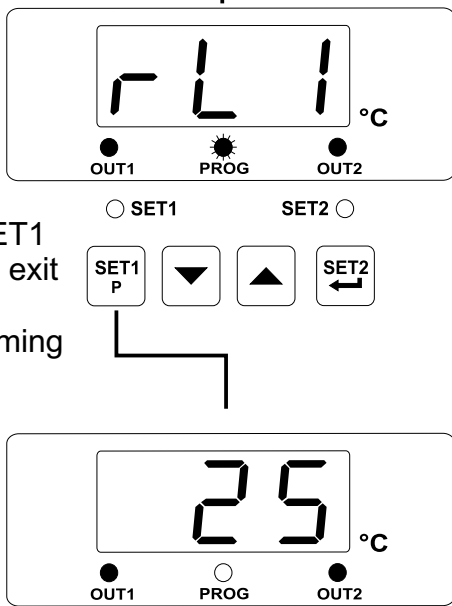

Main Operation Screen



If no operation is done in programming or Set value mode for 20 seconds, device turns to main operation screen automatically.

Programming Screen

In programming screen, Press SET1 button to exit from programming mode and turn to the main operation screen.

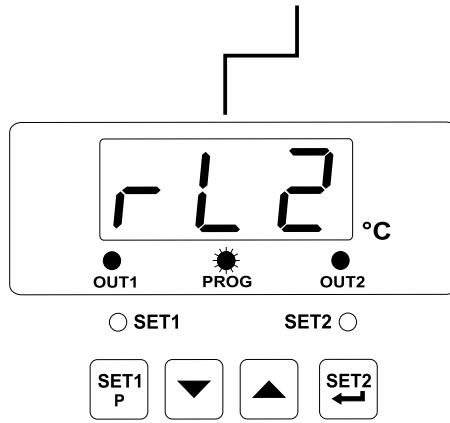

Operation Type Selection for Output-2

Parameter value can be observed by pressing increment button.

If SET2/Enter button is pressed, next parameter is shown.

Press SET1 button to turn to the programming screen without saving the parameter.

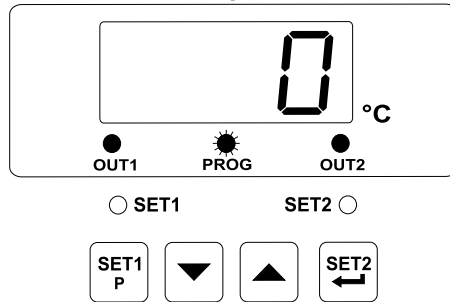

Value of Operation Type Selection for Output-2 Heating is selected

If SET2/Enter button is pressed, next parameter is shown.

Parameter can be changed with increment and decrement buttons.

Programming Screen

Press SET1 button to exit from programming mode.

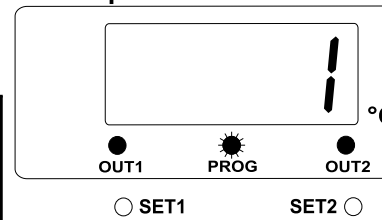
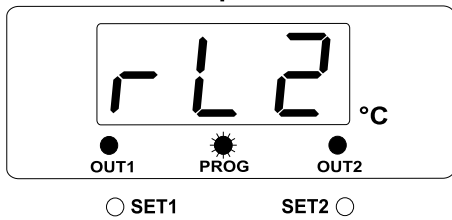

Value of Operation Type Selection for Output-2 Cooling is selected

Press SET2/Enter button for saving parameter value.

Press SET1 button to turn to the programming screen without saving the parameter.



Main Operation Screen



If no operation is done in programming or Set value mode for 20 seconds, device turns to main operation screen automatically.

Programming Screen

In programming screen, Press SET1 button to exit from programming mode and turn to the main operation screen.

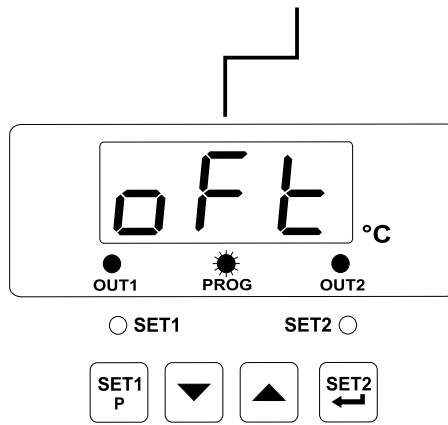

Process Offset Parameter

Parameter value can be observed by pressing increment button.

If SET2/Enter button is pressed, next parameter is shown.

Process Offset Value

If SET2/Enter button is pressed, next parameter is shown.

Parameter can be changed with increment and decrement buttons.

Press SET1 button to turn to the programming screen without saving the parameter.

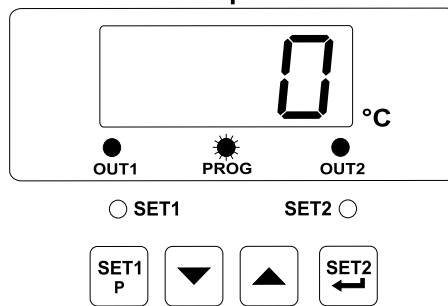

Programming Screen

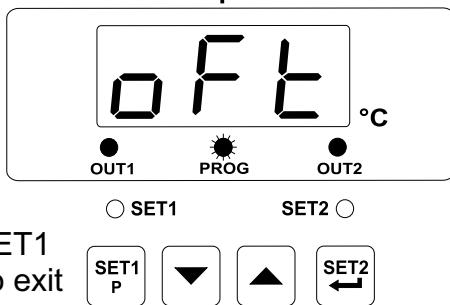

Press SET1 button to exit from programming mode.

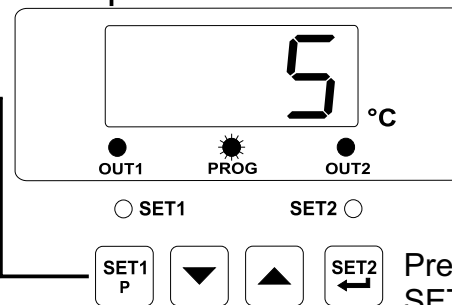

Process Offset Value

Press SET1 button to turn to the programming screen without saving the parameter.

Press SET2/Enter button for saving parameter value.

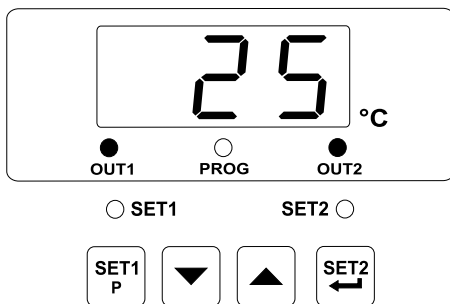

Main Operation Screen



If no operation is done in programming or Set value mode for 20 seconds, device turns to main operation screen automatically.

Programming Screen

In programming screen, Press SET1 button to exit from programming mode and turn to the main operation screen.

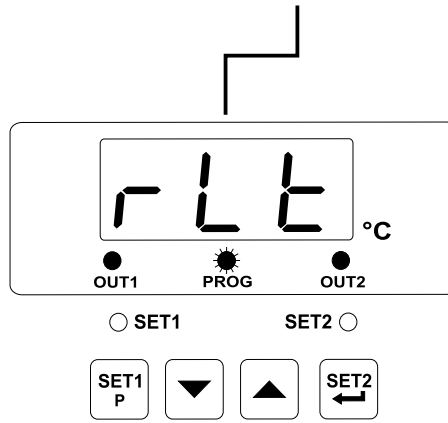

Minimum Pulling Time for Output-1

Parameter value can be observed by pressing increment button.

If SET2/Enter button is pressed, next parameter is shown.

Press SET1 button to turn to the programming screen without saving the parameter.

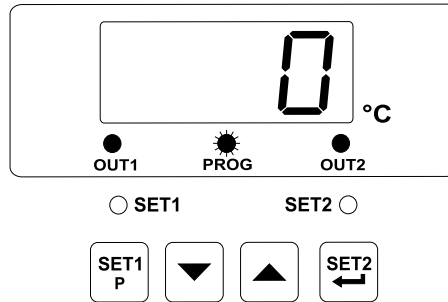

Value of Minimum Pulling Time for Output-1

If SET2/Enter button is pressed, next parameter is shown.

Parameter can be changed with increment and decrement buttons.

Programming Screen

Press SET1 button to exit from programming mode.

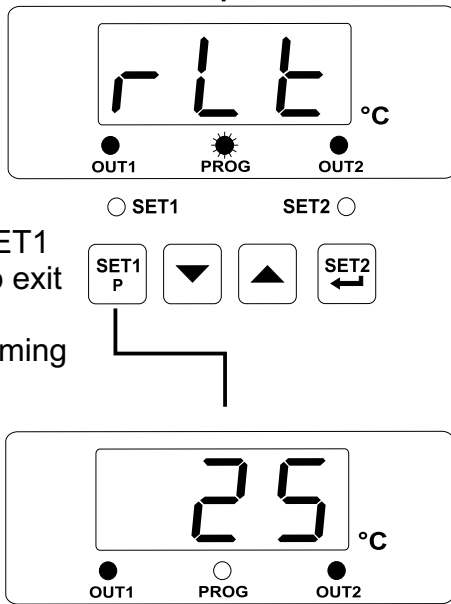

Press SET1 button to turn to the programming screen without saving the parameter.

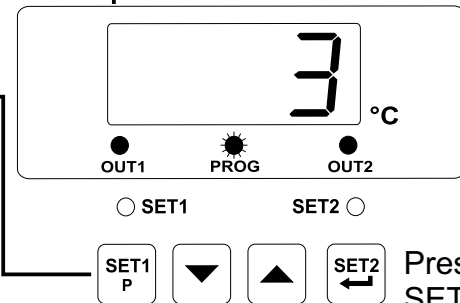

Value of Minimum Pulling Time for Output-1

Press SET2/Enter button for saving parameter value.

Main Operation Screen



If no operation is done in programming or Set value mode for 20 seconds, device turns to main operation screen automatically.

Programming Screen

In programming screen, Press SET1 button to exit from programming mode and turn to the main operation screen.

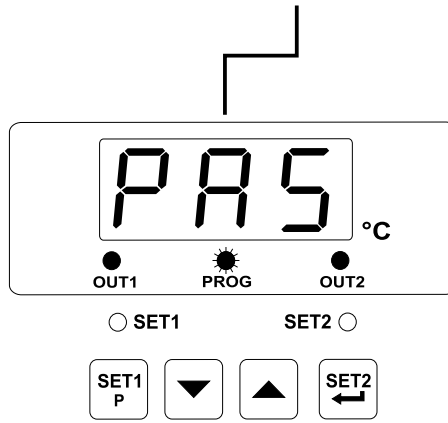

Minimum Pulling Time for Output-1

Parameter value can be observed by pressing increment button.

If SET2/Enter button is pressed, next parameter is shown.

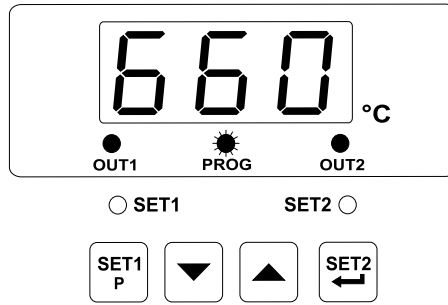

Value of Minimum Pulling Time for Output-1

If SET2/Enter button is pressed, next parameter is shown.

Parameter can be changed with increment and decrement buttons.

Press SET1 button to turn to the programming screen without saving the parameter.

Programming Screen

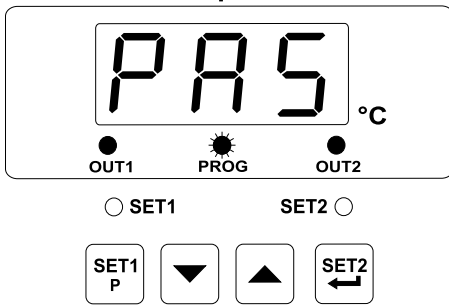

Press SET1 button to exit from programming mode.

Press SET1 button to turn to the programming screen without saving the parameter.

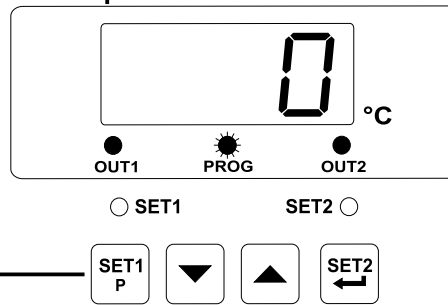

Value of Minimum Pulling Time for Output-1

Press SET2/Enter button for saving parameter value.

Programming Screen

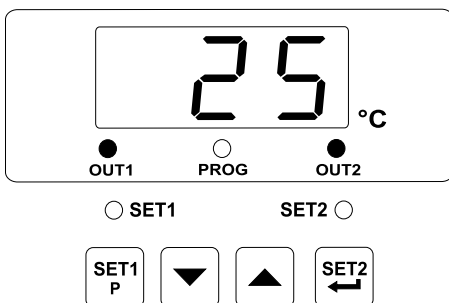

Main Operation Screen

Press SET1 button to exit from programming mode.

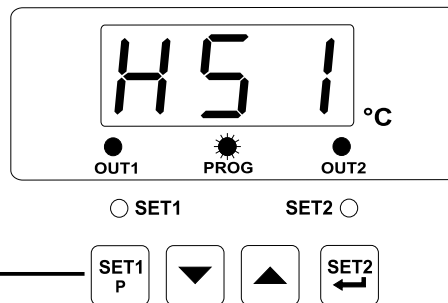

Hysteresis-1 Parameter

It turns to beginning of the programming mode

Continue to press SET2/Enter button for accessing to the parameters.



If no operation is done in programming or Set value mode for 20 seconds, device turns to main operation screen automatically.

5. Parameters

Parameters are divided into two groups as SET and PROGRAM parameters.

5.1 Set Parameters

SET1

SET value for Output-1. Control of output-1 relay is done according to this value.

This value can be adjusted according to input type, minimum and maximum of scale.

SET2

SET value for Output-2. Control of output-2 relay is done according to this value.

This value can be adjusted according to input type, minimum and maximum of scale.

THIS PARAMETER IS NOT ACTIVE IN DEVICES WITH ONE RELAY.

5.2 Program Parameters



Hysteresis Parameter for Output-1 (Default = 3)

1 to 100 °C for TC Type Devices,
1 to 100 °C for PT-100 (0°C , 400°C),
1.0 to 10.0 °C for PT-100 (-19.9°C, 99.9°C),
1 to 100 °C for PTC (-50°C, 150°C),
1.0 to 10.0 °C for PTC (-19.9°C, 99.9°C) and NTC (-19.9°C, 99.9°C)
1 to 20 °C for NTC (-50°C, 100°C)

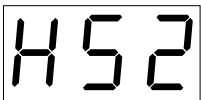

Hysteresis Parameter for Output-2 (Default = 3)

1 to 100 °C for TC Type Devices,
1 to 100 °C for PT-100 (0°C , 400°C),
1.0 to 10.0 °C for PT-100 (-19.9°C, 99.9°C),
1 to 100 °C for PTC (-50°C, 150°C),
1.0 to 10.0 °C for PTC (-19.9°C, 99.9°C) and NTC (-19.9°C, 99.9°C)
1 to 20 °C for NTC (-50°C, 100°C)

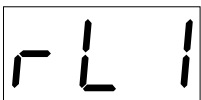

Operation Type Selection parameter for output-1.



Operation type of output-1 relay can be adjusted as "HEATING". Normally energised.



Operation type of output-1 relay can be adjusted "COOLING". Normally de-energised.



"Hs2" and "rL2" PARAMETERS ARE ACTIVE IN DEVICES WITH TWO RELAYS.

If no operation is done in programming or Set value mode for 20 seconds, device turns to main operation screen automatically.

rL2

Operation type selection parameter of output-2.

THIS PARAMETER IS NOT ACTIVE IN DEVICES WITH ONE RELAY.

0

Operation Type of Output-2 relay can be adjusted as "HEATING". Normally energised.

1

Operation Type of Output-2 relay can be adjusted as "COOLING". Normally de-energised.

oFt

Process Offset Parameter (Default = 0).

This parameter is offset for the process value. This defined value is added to the process value.

-10 to 10 °C for TC Type Devices,
-10 to 10 °C for PT-100 (0°C, 400°C),
-10.0 to 10.0 °C for PT-100 (-19.9°C, 99.9°C),
-10 to 10 °C for PTC (-50°C, 150°C),
-10.0 to 10.0 °C for PTC (-19.9°C, 99.9°C) and NTC (-19.9°C, 99.9°C)
-10 to 10 °C for NTC (-50°C, 100°C)

rLt

Minimum Pulling Time Parameter for Output-1 (Minimum Off Time) (Default = 0)

When Output-1 is inactive this time must be expired for Output-1 to become active again. It can be adjusted from 0 to 100 seconds

PAS

Programming Mode Accessing Password (Default =0)

It is used for accessing to the programming mode. It can be adjusted from 0 to 999. If it is selected 0, password is not entered for accessing to the parameters.



"Hs2" and "rL2" PARAMETERS ARE ACTIVE IN DEVICES WITH TWO RELAYS.

If no operation is done in programming or Set value mode for 20 seconds, device turns to main operation screen automatically.

6. Failure Message in ESM-7710 Temperature Controllers

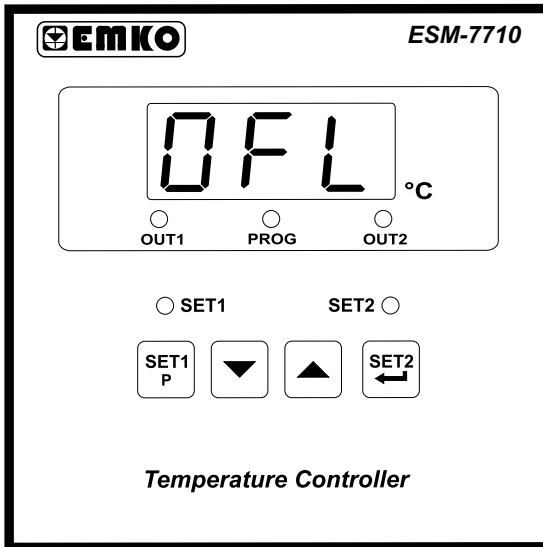

Sensor failure in analogue inputs. It means sensor connection is wrong or there is no sensor.

7. Control Algorithm

7.1 ON/OFF Control

In ON/OFF control algorithm, temperature value is tried to keep equal to set value by opening or closing the last control element. ON/OFF controlled system, temperature value oscillates continuously. Temperature value's oscillation period or amplitude around set value changes according to controlled system. For reducing oscillation period of temperature value, a threshold zone is formed below or around set value and this zone is named hysteresis. Action of control output is described with figures below.

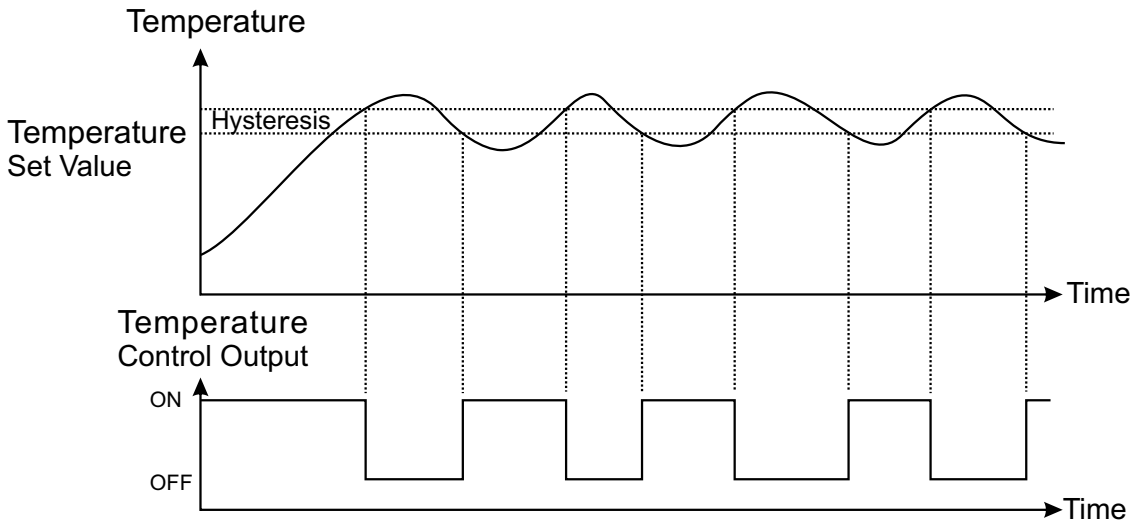

7.1.1 ON/OFF Control in ESM-XX10 Temperature Controller

ON/OFF control form in temperature control output which has heating function

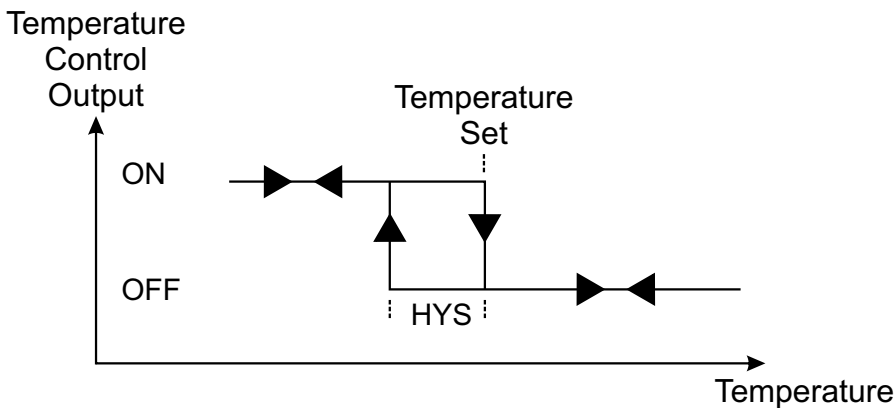

ON/OFF control form in temperature control output which has cooling function

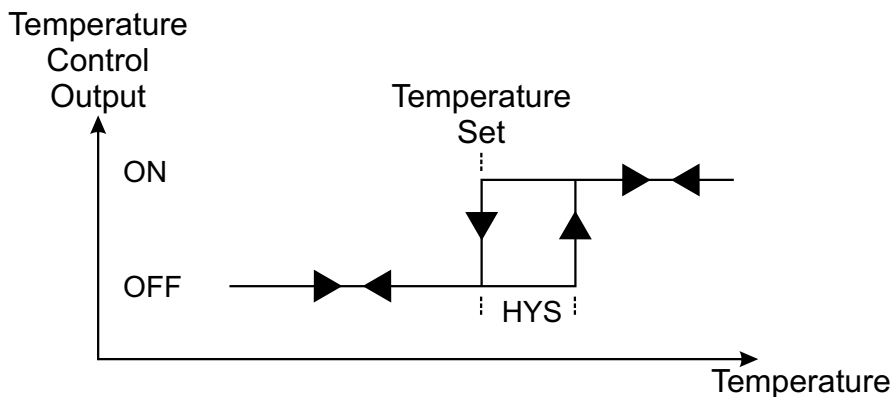

8. Specifications

Device Type	: Temperature Controller
Housing&Mounting	: 72 mm x 72 mm x 95.5 mm DIN Size 43700 plastic Housing for panel mounting. Panel cut-out is 69 x 69 mm Type-1 Enclosure Mounting
Protection Class	: NEMA 4X (IP65 at front, IP20 at rear)
Weight	: Approximately 0.21 Kg
Environmental Ratings	: Standard, indoor at an altitude of less than 2000 meters with non-condensing humidity
Storage/Operating Temperature	: -40 °C to +85 °C / 0 °C to +50 °C
Storage/Operating Humidity	: 90 % max. (Non-condensing)
Installation	: Fixed installation
Over Voltage Category	: II
Pollution Degree	: II, office or workplace, none conductive pollution
Operating Conditions	: Continuous
Supply Voltage and Power	: 230 V ~ (±15%) 50/60 Hz. 3 VA 115 V ~ (±15%) 50/60 Hz. 3 VA 24 V ~ (±15%) 50/60 Hz. 3 VA 24 V ≍ (-%15, +%10) 50/60 Hz. 3 VA
Temperature Inputs	: NTC, PTC, TC, RTD
NTC Input Types	: NTC (10 kΩ @.25 °C)
PTC Input Type	: PTC (1000 Ω @.25 °C)
Thermocouple Input Types	: J, K (IEC584.1)(ITS90)
Thermoresistance Input Type	: PT 100 (IEC751)(ITS90)
Accuracy	: ± 1% of full scale for thermocouple, thermoresistance
Cold Junction Compensation	: Automatically ± 0.1 °C / 1 °C
Line Compensation	: Maximum 10 Ω
Sensor Break Protection	: Upscale
Sampling Cycle	: 3 samples per second
Control Form	: ON / OFF
Relay Outputs	: 7 A@250 V ~ at resistive load (Electrical Life : 100.000 Operation (Full Load))
Opsiyonel SSR Driver Outputs	: Maximum 23 mA, Maximum 15 V ===
Display	: 14 mm Red 3 digits LED display
Led Indicators	: For ESM-7710-A.BC.0.1/00.00; SET (Green), OUT (Red), PROG (Red) 3 mm Led For ESM-7710-A.BC.0.1/01.00; SET1(Green),SET2(Green), OUT1 (Red),OUT2 (Red), PROG (Red) 3 mm Led
Approvals	: UL Recognized Component (File No : E 254103), EAC, CE

9. Other Informations

Manufacturer Information:

Emko Elektronik Sanayi ve Ticaret A.Ş.
Demirtaş Organize Sanayi Bölgesi Karanfil Sk. No:6 16369
BURSA/TURKEY

Phone : +90 224 261 1900

Fax : +90 224 261 1912

Repair and Maintenance Service Information:

Emko Elektronik Sanayi ve Ticaret A.Ş.
Demirtaş Organize Sanayi Bölgesi Karanfil Sk. No:6 16369
BURSA/TURKEY

Phone : +90 224 261 1900

Fax : +90 224 261 1912



Thank you very much for your preference to use Emko Elektronik Products.

www.emkoelektronik.com.tr