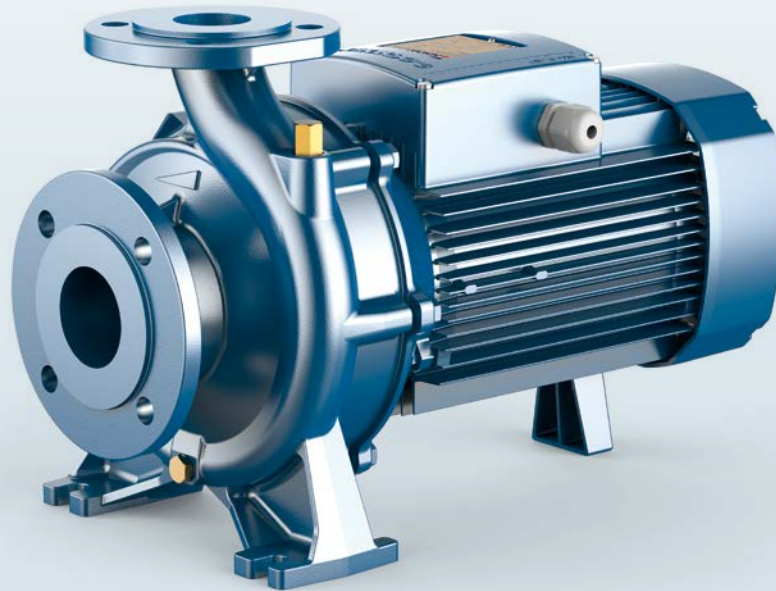

Standardised "EN 733" centrifugal pumps

 Clean water

 Industrial use

PERFORMANCE RANGE

- Flow rate up to **6000 l/min** (360 m³/h)
- Head up to **98 m**

APPLICATION LIMITS

- Manometric suction lift up to **7 m**
- Liquid temperature between **-10 °C** and **+90 °C**
- Ambient temperature between **-10 °C** and **+40 °C**
- Max. pressure in pump body **10 bar** (PN10)
- Continuous service **S1**

CONSTRUCTION AND SAFETY STANDARDS

EN 60335-1
IEC 60335-1
CEI 61-150

EN 60034-1
IEC 60034-1
CEI 2-3



Pump body dimensions in compliance with **EN 733**

EU REGULATION N. 547/2012

INSTALLATION AND USE

- Water supply
- Pressure boosting
- Irrigation
- Water circulation in air-conditioning units
- Cleaning sets
- Firefighting sets
- Industrial applications
- Agricultural applications

Installation needs to be undertaken in well ventilated closed areas or anyway protected from bad weather.

OPTIONS AVAILABLE ON REQUEST

- Counter flange KIT complete with bolts, nuts and washers
- Special mechanical seal
- Other voltages or 60 Hz frequency
- Compatibility with hotter or colder liquids
- Compatibility with hotter or colder environments

CERTIFICATIONS

Company with management system certified DNV
ISO 9001: QUALITY



PERFORMANCE RANGE

50 Hz n= 2900 min⁻¹

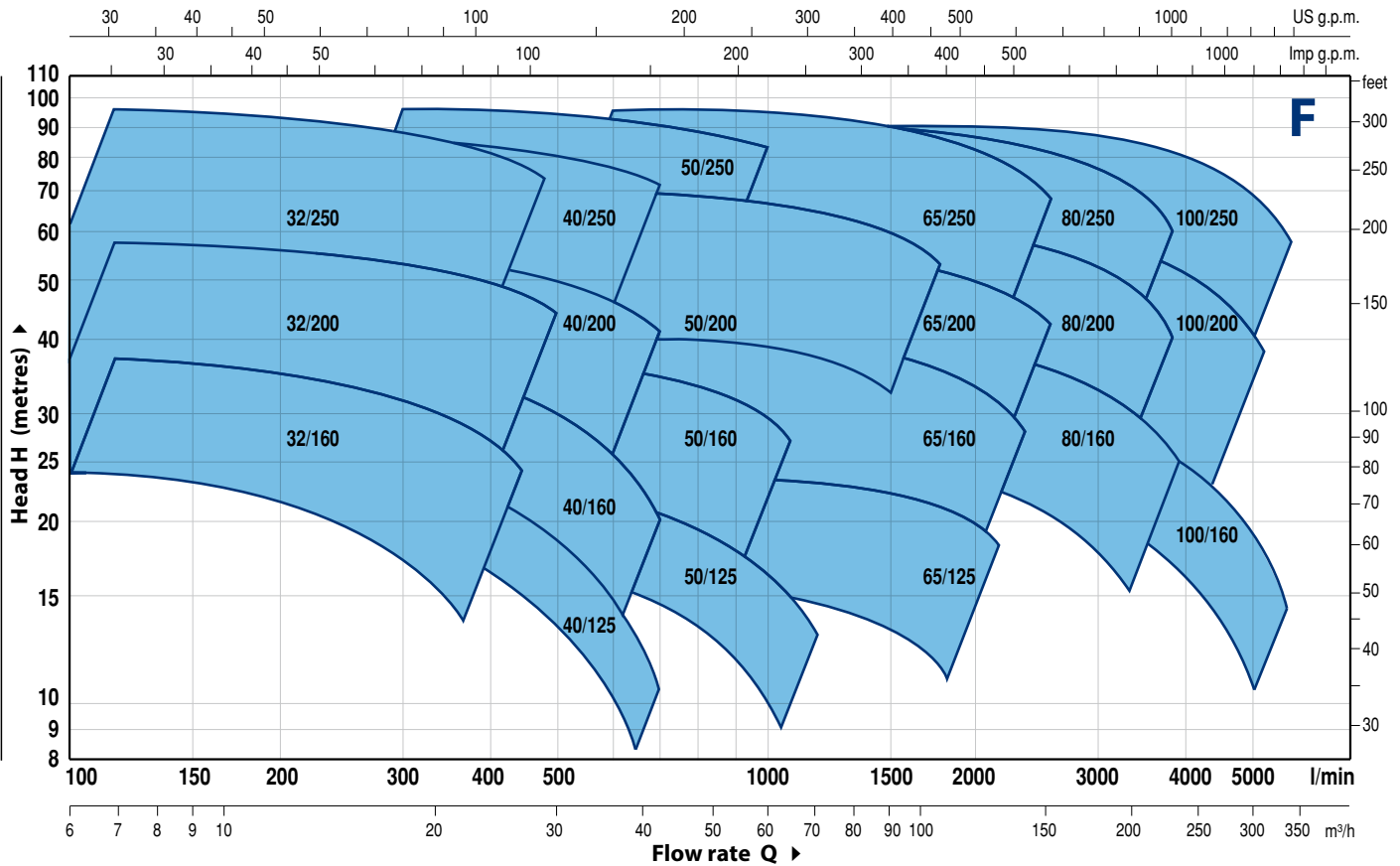

PERFORMANCE DATA

50 Hz n= 2900 min⁻¹

MODEL	POWER (P ₂)		▲	PERFORMANCE	
	kW	HP		Q l/min	H metres
F 32/160C	1.5	2	IE3	100 – 350	24 – 14
F 32/160B	2.2	3		100 – 400	30 – 17
F 32/160A	3	4		100 – 450	37 – 24
F 32/200C	4	5.5		100 – 450	44 – 31.5
F 32/200B	5.5	7.5		100 – 500	51 – 36
F 32/200A	7.5	10		100 – 500	57 – 44
F 32/200BH	3	4		100 – 300	45 – 37
F 32/200AH	4	5.5		100 – 320	55 – 44
F 32/250C	9.2	12.5		100 – 450	75 – 60
F 32/250B	11	15		100 – 500	87 – 70
F 32/250A	15	20	100 – 500	97 – 80	
F 40/125C	1.1	1.5	IE3	100 – 550	16 – 6
F 40/125B	1.5	2		100 – 600	20.5 – 9
F 40/125A	2.2	3		100 – 700	26 – 10
F 40/160C	2.2	3		100 – 600	27 – 14
F 40/160B	3	4		100 – 600	32 – 20
F 40/160A	4	5.5		100 – 700	38 – 20
F 40/200B	5.5	7.5		100 – 700	47 – 28
F 40/200A	7.5	10		100 – 700	55 – 41
F 40/250C	9.2	12.5		100 – 700	64 – 47
F 40/250B	11	15		100 – 700	71 – 55
F 40/250A	15	20	100 – 700	88 – 72	
F 50/125C	2.2	3	IE3	300 – 1200	17.5 – 6
F 50/125B	3	4		300 – 1200	20.7 – 9
F 50/125A	4	5.5		300 – 1200	23.5 – 13
F 50/160C	4	5.5		300 – 1000	27 – 16
F 50/160B	5.5	7.5		300 – 1100	32 – 21
F 50/160A	7.5	10		300 – 1100	37 – 27
F 50/200C	11	15		400 – 1700	44 – 30
F 50/200B	15	20		400 – 1700	52 – 38
F 50/200A	18.5	25		400 – 1800	61 – 45
F 50/200AR	22	30		400 – 1800	69 – 53
F 50/250D	9.2	12.5	300 – 900	51 – 32	
F 50/250C	11	15	300 – 900	59 – 42	
F 50/250B	15	20	300 – 1000	72 – 59	
F 50/250A	18.5	25	300 – 1000	85 – 73	
F 50/250AR	22	30	300 – 1000	95 – 83	

MODEL	POWER (P ₂)		▲	PERFORMANCE	
	kW	HP		Q l/min	H metres
F 65/125C	4	5.5	IE3	600 – 1800	16 – 11
F 65/125B	5.5	7.5		600 – 2000	18 – 13
F 65/125A	7.5	10		600 – 2200	23 – 18
F 65/160C	9.2	12.5		600 – 2200	32 – 22
F 65/160B	11	15		600 – 2400	36.5 – 23
F 65/160A	15	20		600 – 2400	40.5 – 28
F 65/200B	15	20		200 – 2400	44 – 30.5
F 65/200A	18.5	25		200 – 2500	50 – 36.5
F 65/200AR	22	30		200 – 2600	57 – 42
F 65/250C	30	40		400 – 2350	76 – 53
F 65/250B	37	50	400 – 2500	87 – 62	
F 65/250A	45	60	400 – 2600	95 – 68	
F 80/160D	11	15	IE3	500 – 4000	25 – 10
F 80/160C	15	20		500 – 4000	30 – 15
F 80/160B	18.5	25		500 – 4000	35 – 20
F 80/160A	22	30		500 – 4000	40 – 25
F 80/200B	30	40		500 – 3650	56 – 34.5
F 80/200A	37	50		500 – 3900	62 – 40
F 80/250B	45	60		600 – 3600	77 – 54
F 80/250A	55	75		600 – 3900	88.5 – 60
F 100/160C	15	20		1000 – 5000	30 – 12
F 100/160B	18.5	25		1000 – 5200	34 – 14.5
F 100/160A	22	30	1000 – 5500	38 – 17.5	
F 100/200C	30	40	IE3	833 – 4650	51 – 28
F 100/200B	37	50		833 – 4900	57 – 33
F 100/200A	45	60		833 – 5250	63 – 38
F 100/250B	55	75		800 – 5150	75 – 48
F 100/250A	75	100		800 – 5750	89 – 58

Q = Flow rate

H = Total manometric head

Tolerance of characteristic curves in compliance with EN ISO 9906 Grade 3B.

▲ Three-phase motor efficiency class (IEC 60034-30-1)

F32/160

CHARACTERISTIC CURVES AND PERFORMANCE DATA

50 Hz n = 2900 min⁻¹ HS = 0 m

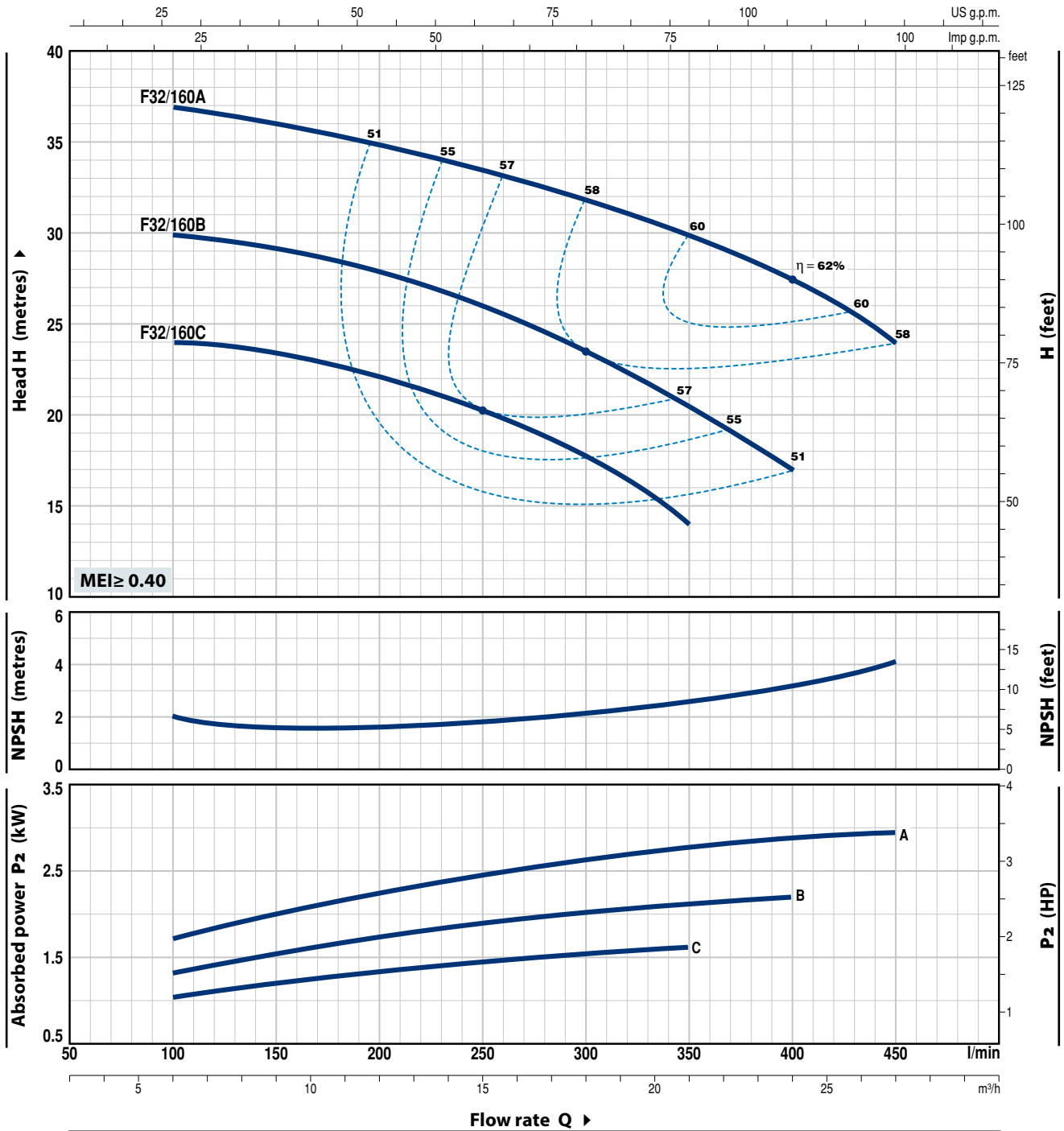

MODEL		POWER (P ₂)		Q	Flow rate									
Single-phase	Three-phase	kW	HP		m ³ /h	0	6	9	12	15	18	21	24	27
Fm 32/160C	F 32/160C	1.5	2	H metres	0	100	150	200	250	300	350	400	450	
Fm 32/160B	F 32/160B	2.2	3		25	24	23.5	22	20.5	18	14			
-	F 32/160A	3	4		31	30	29	28	26	23.5	20.5	17		
					38	37	36	35	33.5	31.5	30	27.5	24	

Q = Flow rate H = Total manometric head HS = Suction height

Tolerance of characteristic curves in compliance with EN ISO 9906 Grade 3B.

CHARACTERISTIC CURVES AND PERFORMANCE DATA

50 Hz n = 2900 min⁻¹ HS = 0 m

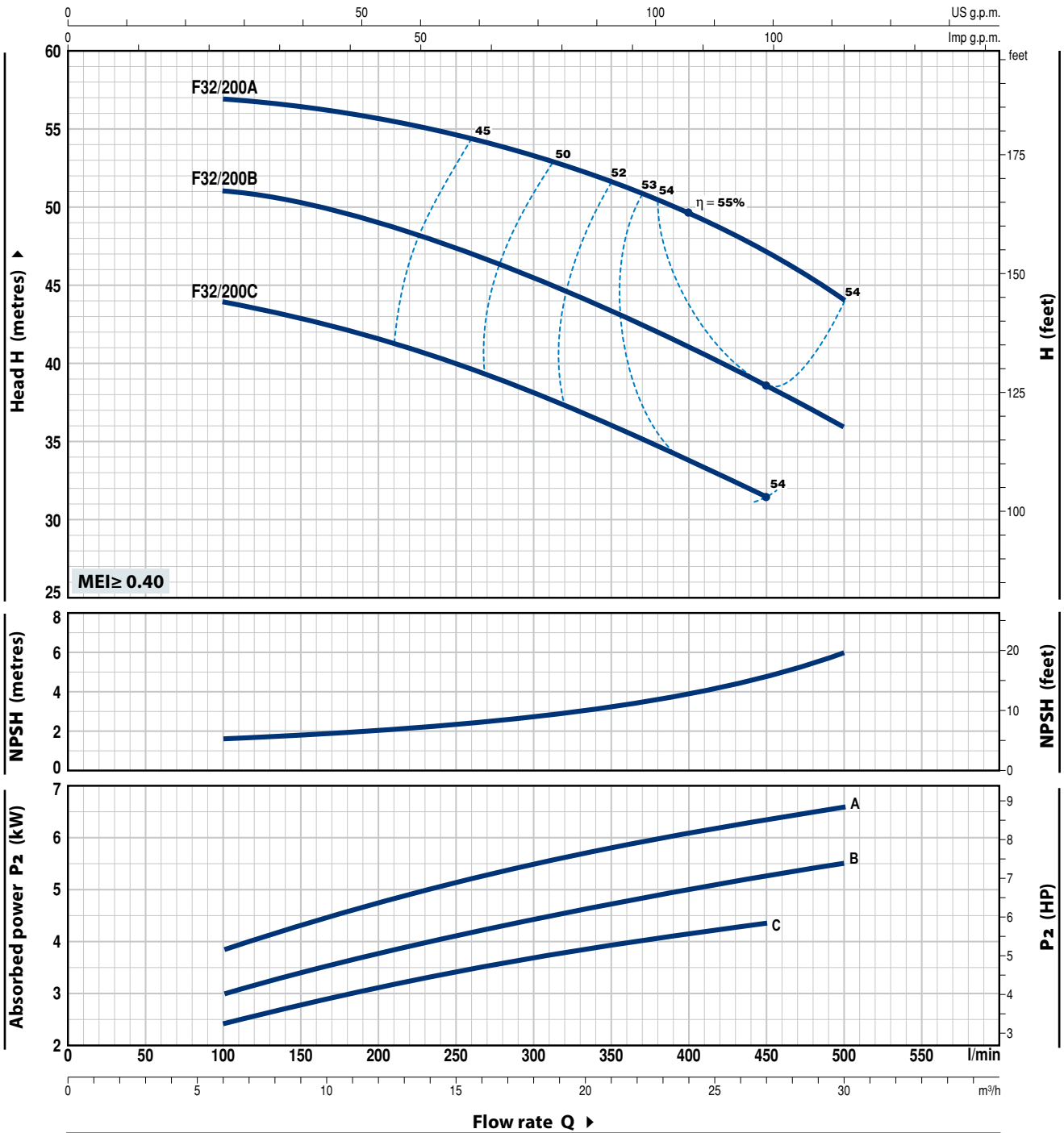

MODEL	POWER (P ₂)		Q	Flow rate											
	kW	HP		m ³ /h	0	6	9	12	15	18	21	24	27	30	
Three-phase			l/min	0	100	150	200	250	300	350	400	450	500		
F 32/200C	4	5.5	H metres	46	44	43	41.5	40	38	36	34	31.5			
F 32/200B	5.5	7.5		52	51	50.5	49	47	45	43	41	38.5	36		
F 32/200A	7.5	10		60	57	56.5	56	55	53.5	52	50	47	44		

Q = Flow rate H = Total manometric head HS = Suction height

Tolerance of characteristic curves in compliance with EN ISO 9906 Grade 3B.

F32/200H

CHARACTERISTIC CURVES AND PERFORMANCE DATA

50 Hz n = 2900 min⁻¹ HS = 0 m

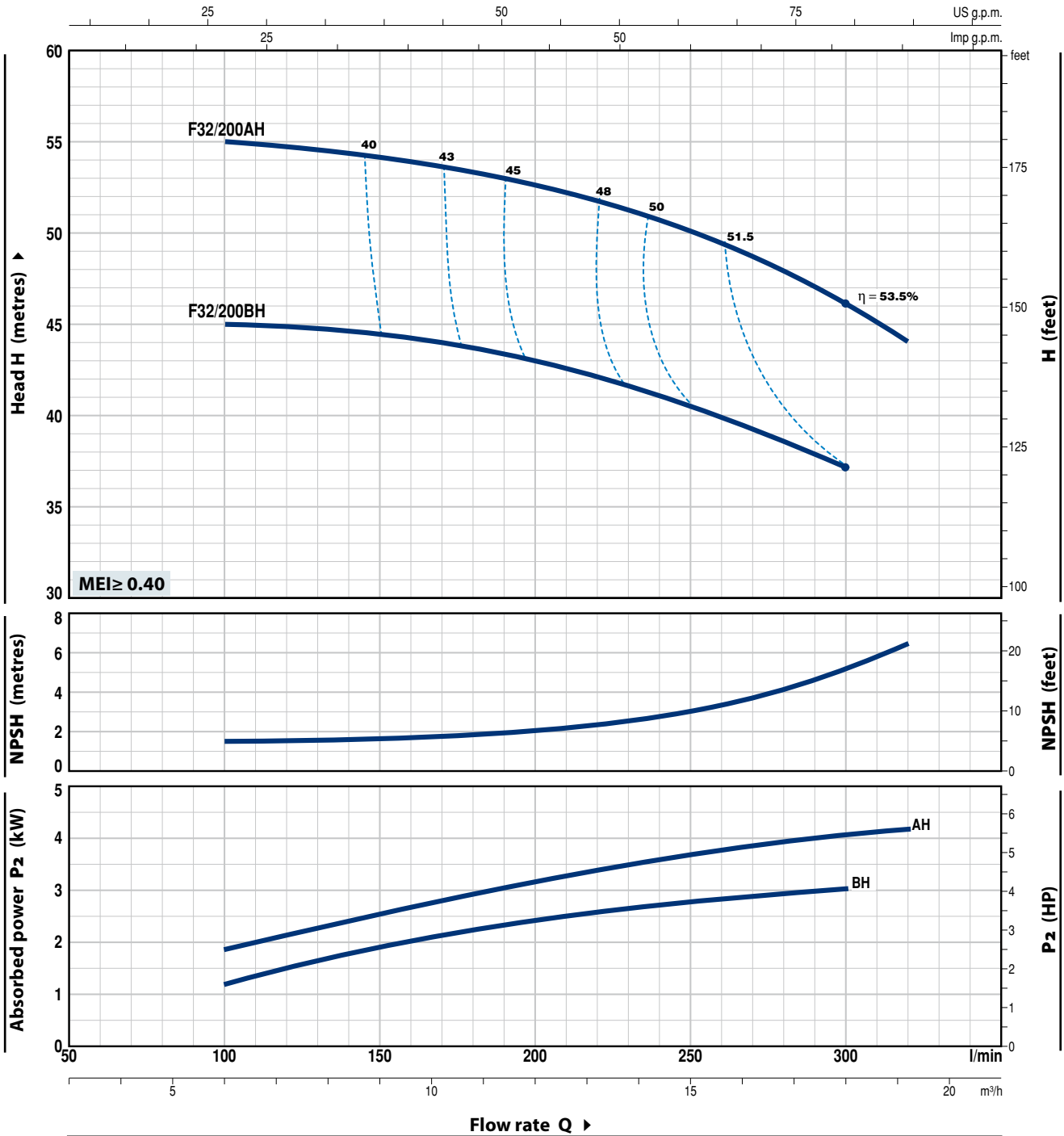

MODEL	POWER (P ₂)		Q	Flow rate Q						
	kW	HP		0	6	9	12	15	18	19.2
Three-phase				0	100	150	200	250	300	320
F 32/200BH	3	4	H metres	47	45	44.5	43	40.5	37	
F 32/200AH	4	5.5		57	55	54	52.5	50	46	44

Q = Flow rate H = Total manometric head HS = Suction height

Tolerance of characteristic curves in compliance with EN ISO 9906 Grade 3B.

CHARACTERISTIC CURVES AND PERFORMANCE DATA

50 Hz n = 2900 min⁻¹ HS = 0 m

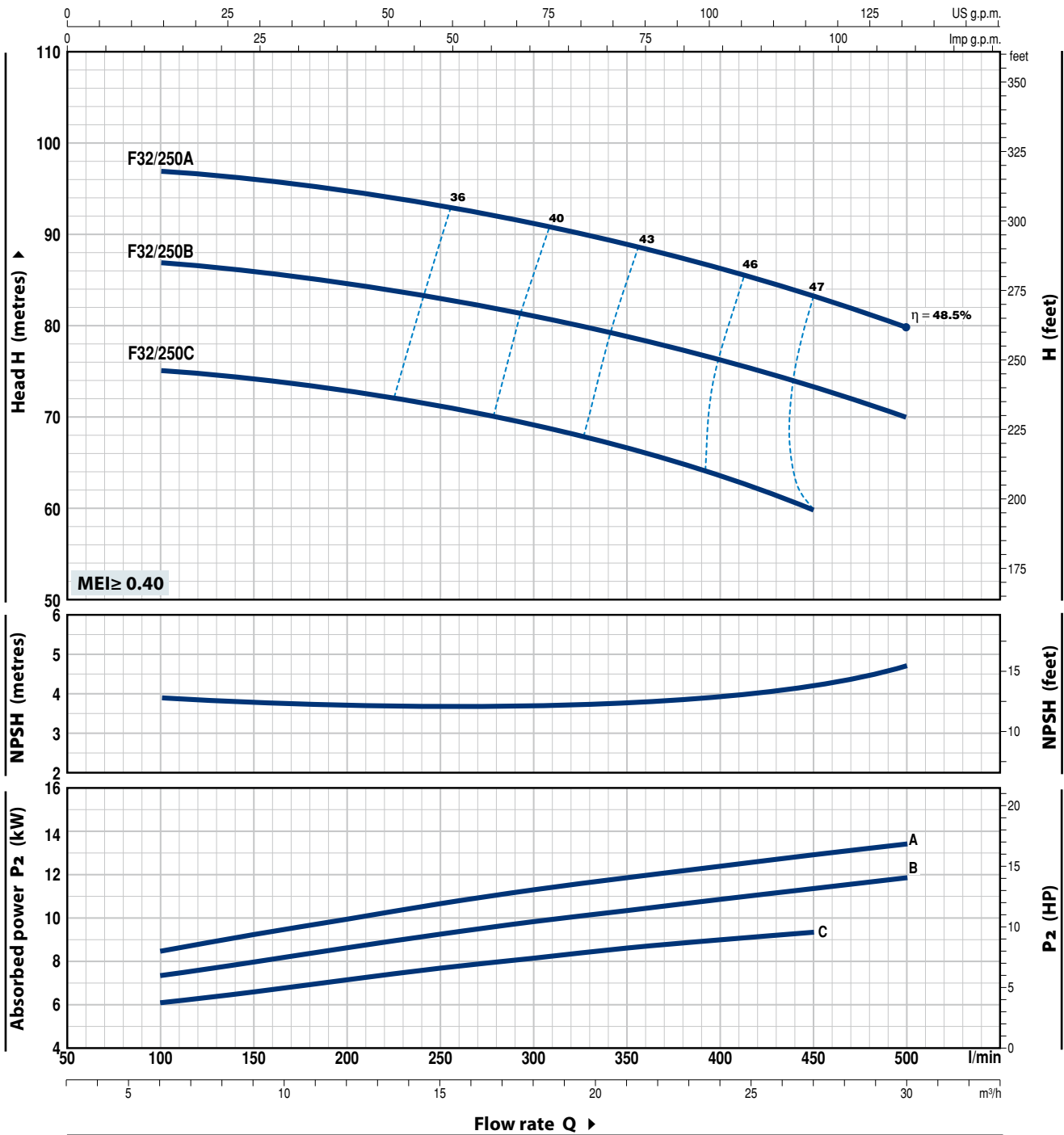

MODEL	POWER (P ₂)		Q	Flow rate												
	kW	HP		m ³ /h	0	6	9	12	15	18	21	24	27	30		
Three-phase			l/min	0	100	150	200	250	300	350	400	450	500			
F 32/250C	9.2	12.5	H metres	76	75	74.5	73	71.5	69.5	67	64	60				
F 32/250B	11	15		88	87	86	85	83	81	79	76.5	73.5	70			
F 32/250A	15	20		98	97	96	95	93	91	89	86.5	83.5	80			

Q = Flow rate H = Total manometric head HS = Suction height

Tolerance of characteristic curves in compliance with EN ISO 9906 Grade 3B.

F40/125

CHARACTERISTIC CURVES AND PERFORMANCE DATA

50 Hz n = 2900 min⁻¹ HS = 0 m

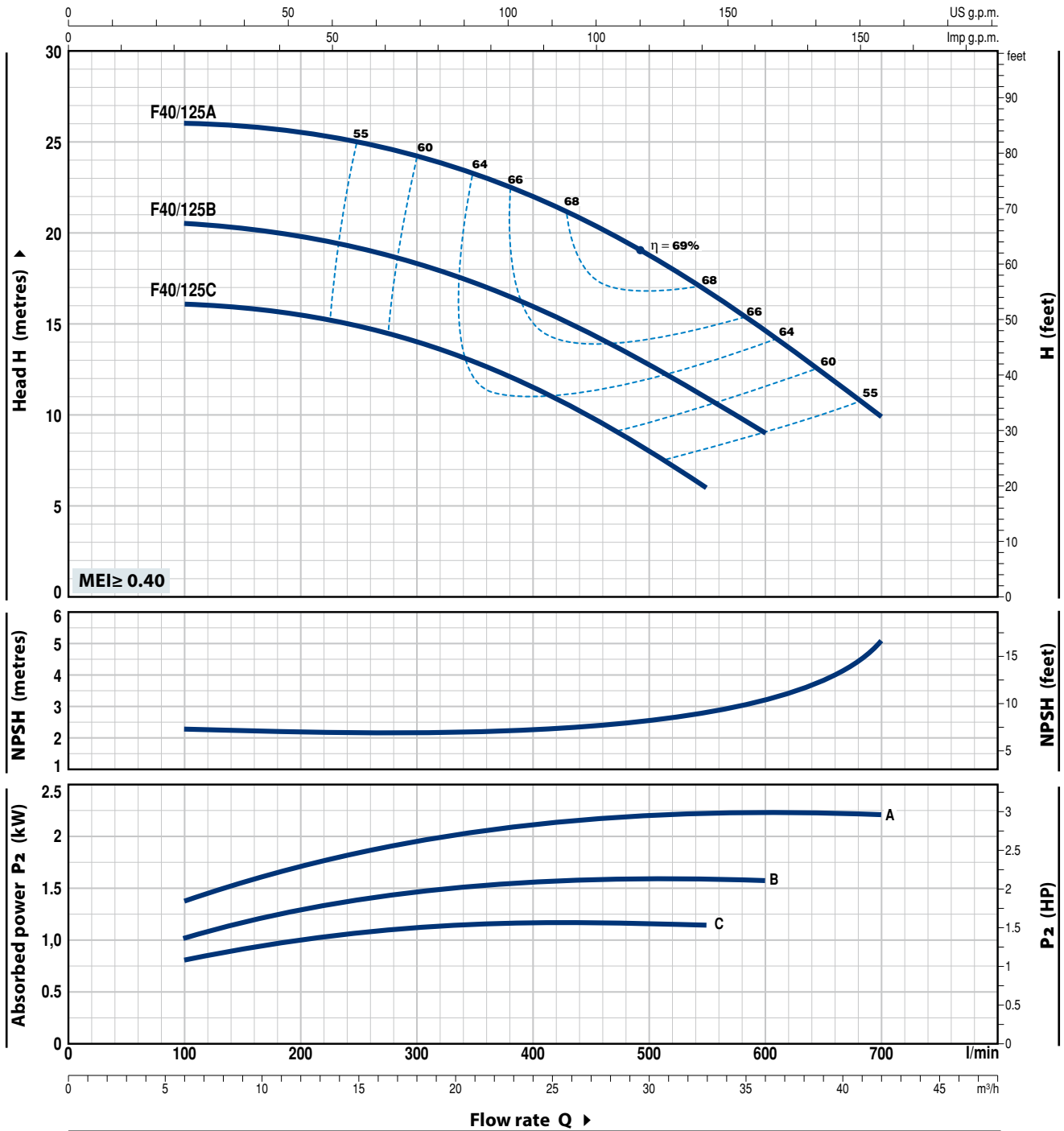

MODEL		POWER (P ₂)		Q	Flow rate									
Single-phase	Three-phase	kW	HP		m ³ /h	0	6	12	18	24	30	33	36	39
Fm 40/125C	F 40/125C	1.1	1.5	l/min	0	100	200	300	400	500	550	600	650	700
	Fm 40/125B	1.5	2	H metres	16	16	15.5	14	11.5	8	6			
-	F 40/125A	2.2	3		20.5	20.5	19.8	18.5	16	12.8	11	9		
					26	26	25.5	24	22	18.5	17	14.5	12.5	10

Q = Flow rate H = Total manometric head HS = Suction height

Tolerance of characteristic curves in compliance with EN ISO 9906 Grade 3B.

CHARACTERISTIC CURVES AND PERFORMANCE DATA

50 Hz n = 2900 min⁻¹ HS = 0 m

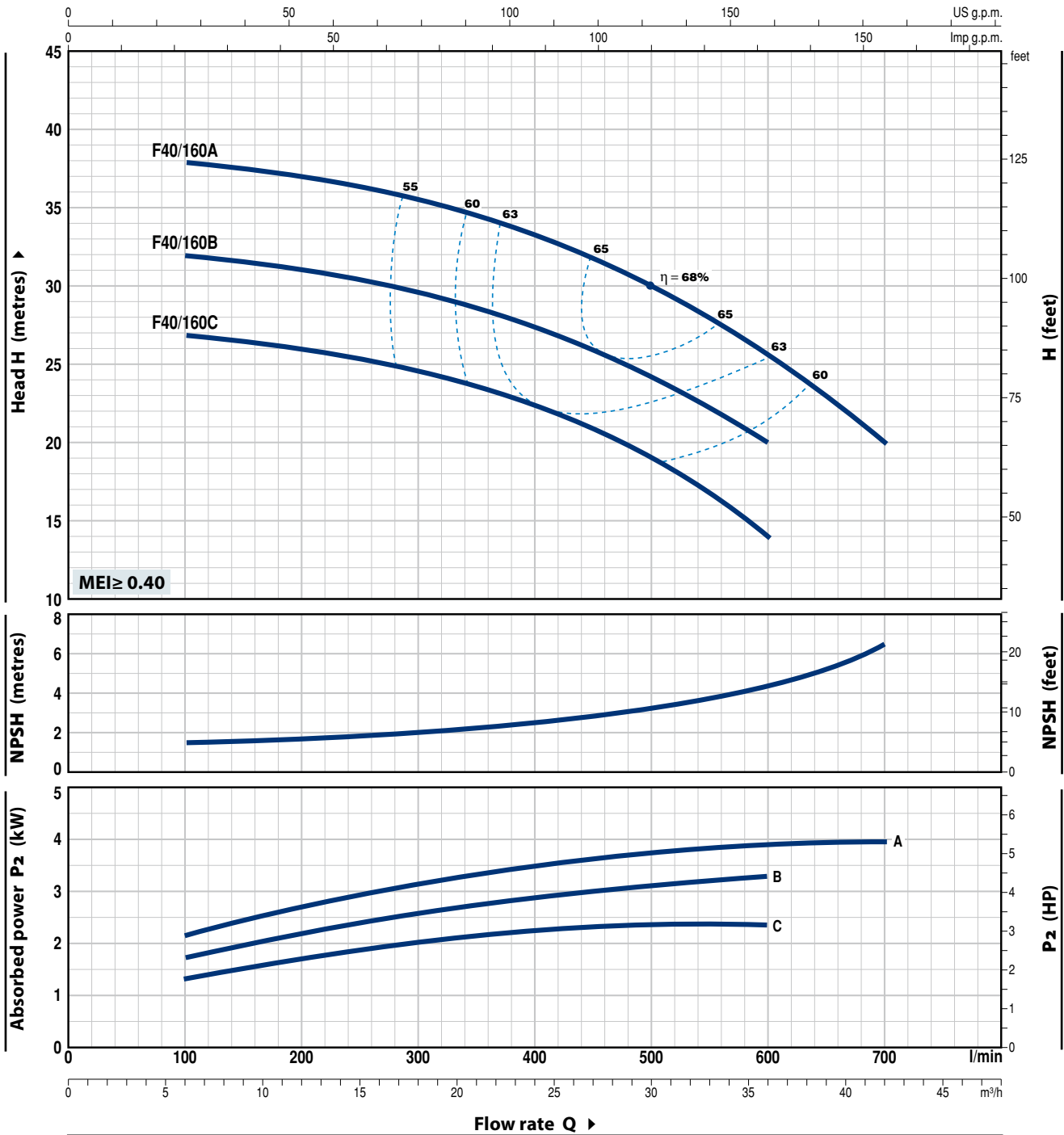

MODEL		POWER (P ₂)		Q m ³ /h l/min	0	6	9	12	15	18	24	30	36	42
Single-phase	Three-phase	kW	HP		0	100	150	200	250	300	400	500	600	700
Fm 40/160C	F 40/160C	2.2	3	H metres	27	27	26.5	26	25.5	25	22.5	19	14	
-	F 40/160B	3	4		32	32	31.5	31	30.5	30	27.5	24	20	
-	F 40/160A	4	5.5		38	38	37.8	37	36.5	36	33.5	30	26	20

Q = Flow rate H = Total manometric head HS = Suction height

Tolerance of characteristic curves in compliance with EN ISO 9906 Grade 3B.

F40/200

CHARACTERISTIC CURVES AND PERFORMANCE DATA

50 Hz n = 2900 min⁻¹ HS = 0 m

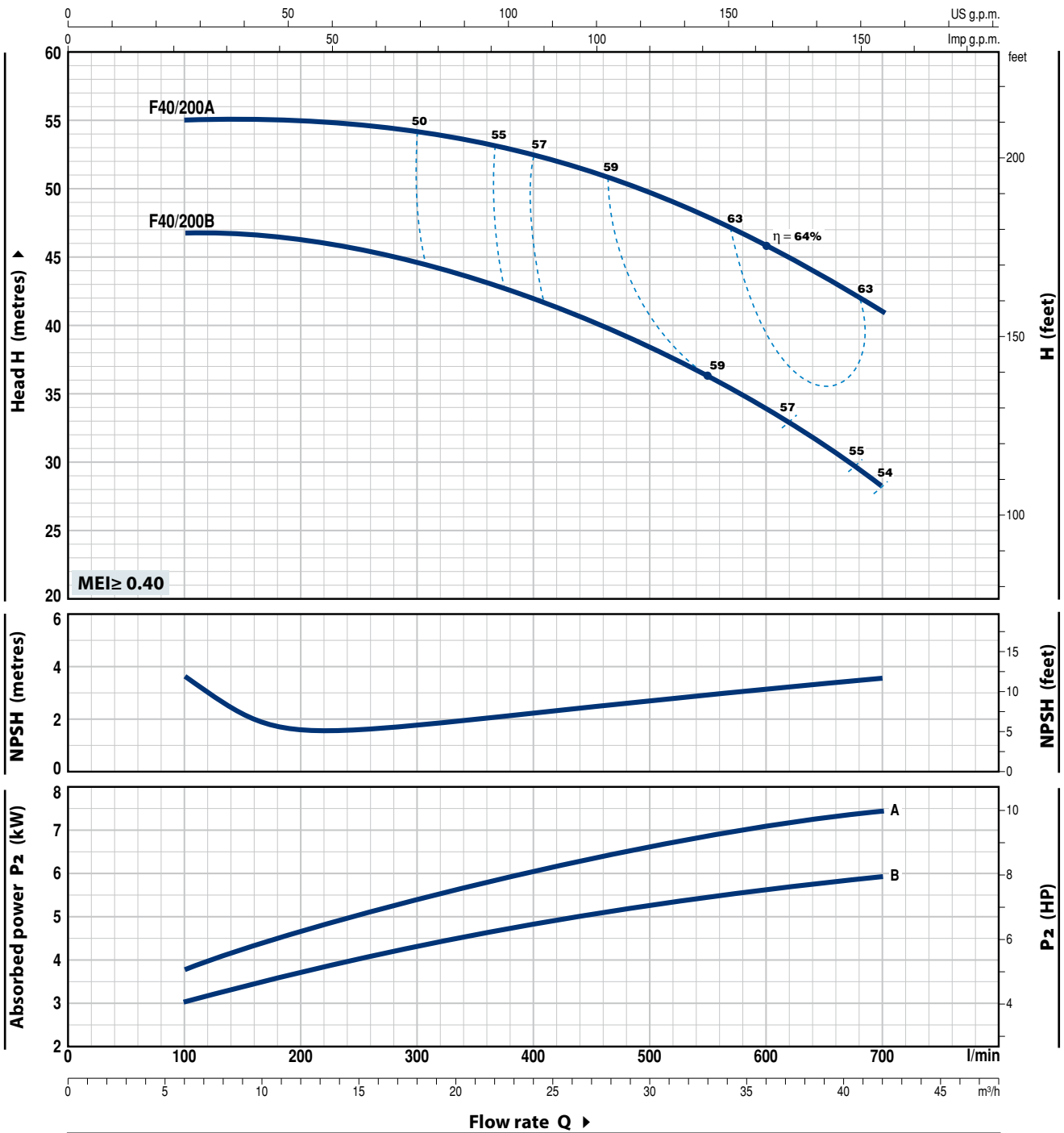

MODEL	POWER (P ₂)		Q	Flow rate											
	kW	HP		m ³ /h	0	6	9	12	15	18	24	30	36	42	
Three-phase			l/min	0	100	150	200	250	300	400	500	600	700		
F 40/200B	5.5	7.5	H metres	48	47	46.5	46	45.5	44.5	42	38	34	28		
F 40/200A	7.5	10		56	55	55	55	54.5	54	52.5	49.5	46	41		

Q = Flow rate H = Total manometric head HS = Suction height

Tolerance of characteristic curves in compliance with EN ISO 9906 Grade 3B.

CHARACTERISTIC CURVES AND PERFORMANCE DATA

50 Hz n = 2900 min⁻¹ HS = 0 m

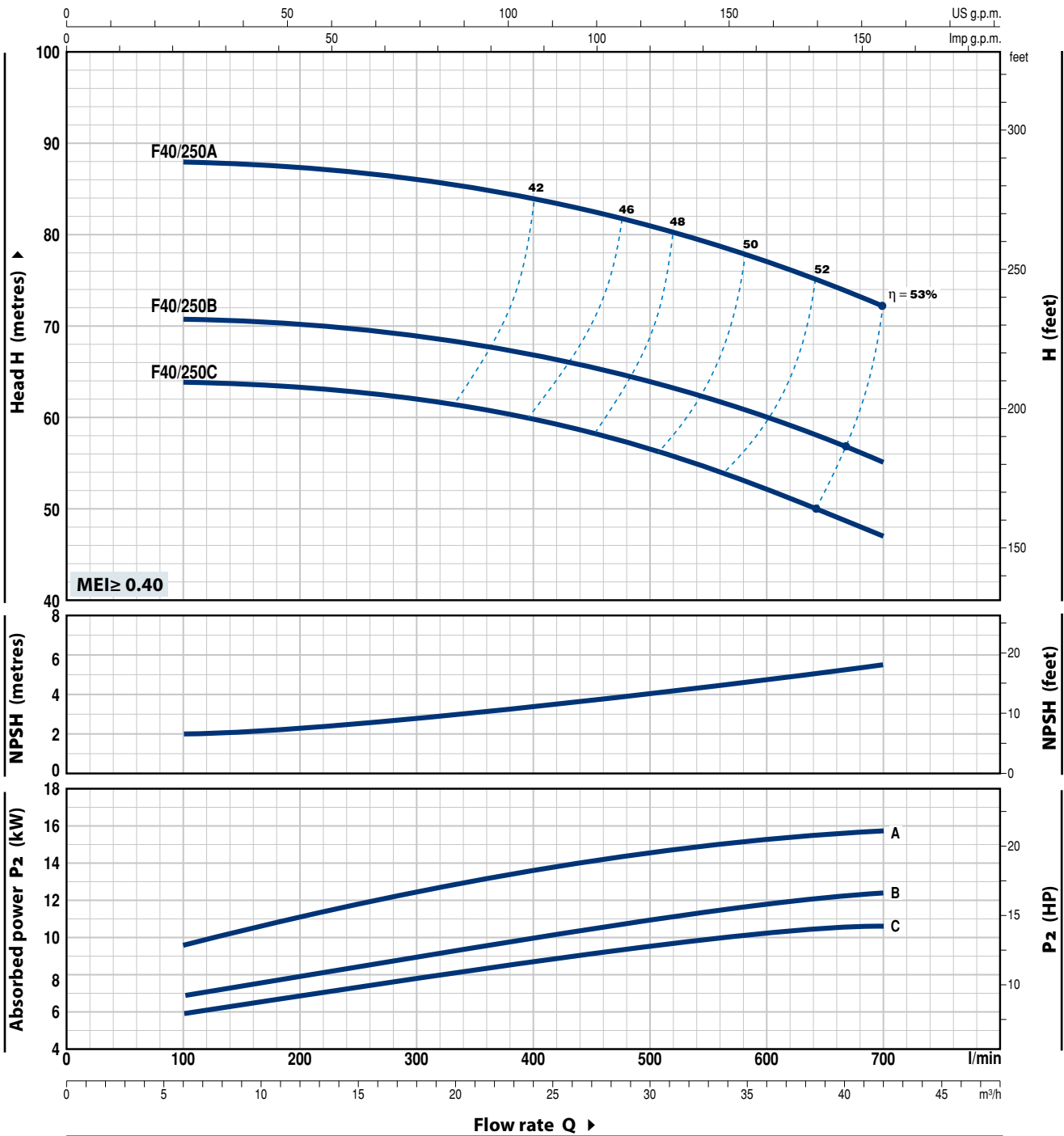

MODEL	POWER (P ₂)		Q	Flow rate											
	kW	HP		m ³ /h	0	6	9	12	15	18	24	30	36	42	
Three-phase			l/min	0	100	150	200	250	300	400	500	600	700		
F 40/250C	9.2	12.5	H metres	64	64	63.5	63	62.5	62	60	56.5	52.5	47		
F 40/250B	11	15		71	71	70.5	70	69.5	69	67	64	60	55		
F 40/250A	15	20		88	88	87.5	87	86.5	86	84	81	77	72		

Q = Flow rate H = Total manometric head HS = Suction height

Tolerance of characteristic curves in compliance with EN ISO 9906 Grade 3B.

F50/125

CHARACTERISTIC CURVES AND PERFORMANCE DATA

50 Hz n = 2900 min⁻¹ HS = 0 m

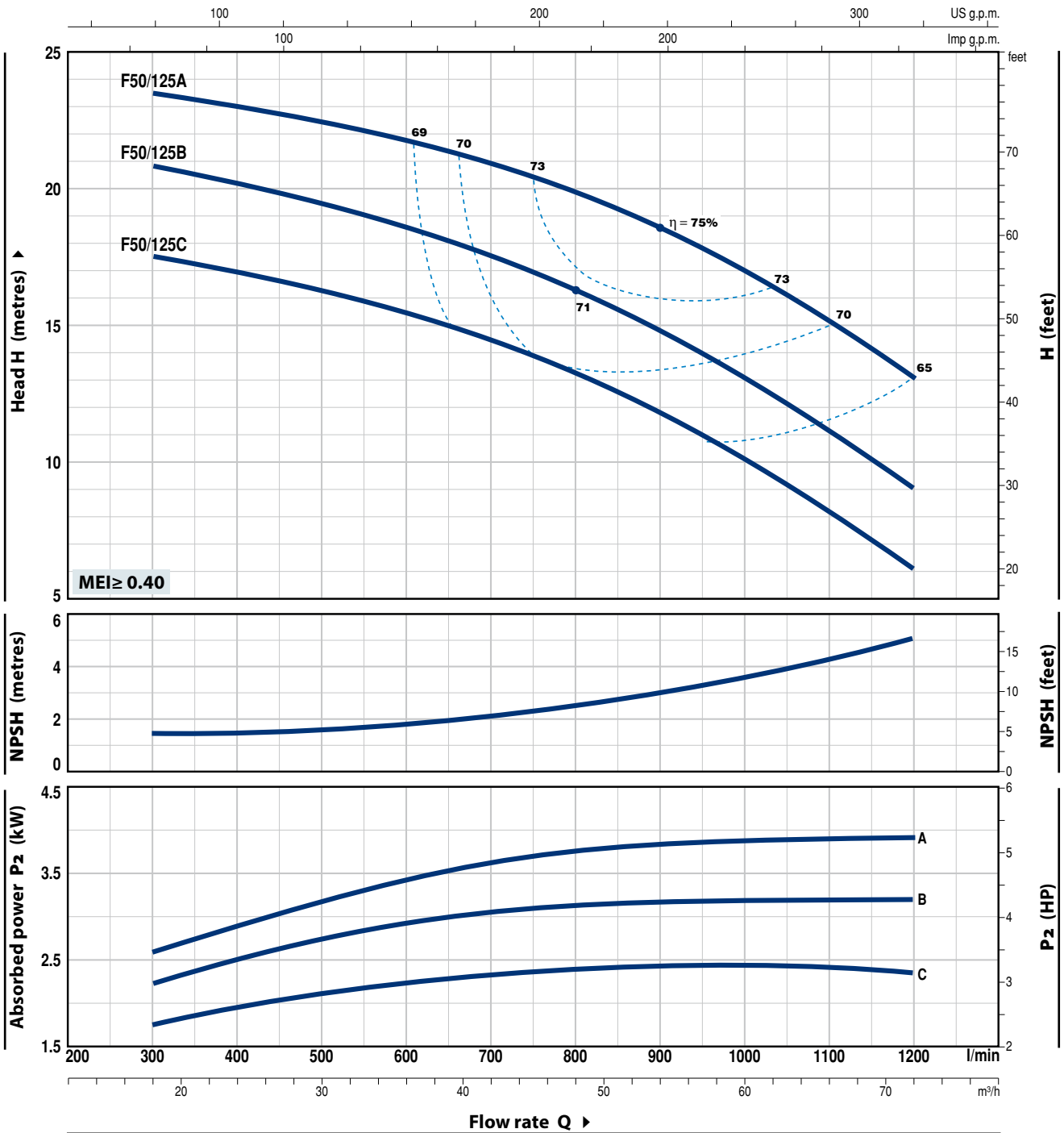

MODEL		POWER (P ₂)		Q	Flow rate												
Single-phase	Three-phase	kW	HP		m ³ /h	0	18	24	30	36	42	48	54	60	66	72	
Fm 50/125C	F 50/125C	2.2	3	H metres	0	300	400	500	600	700	800	900	1000	1100	1200		
-	F 50/125B	3	4		18.5	17.5	17	16.5	15.5	14.8	13.5	12	10.5	8.2	6		
-	F 50/125A	4	5.5		21.5	20.7	20	19.5	18.8	17.8	16.5	15	13.5	11.2	9		
						24.5	23.5	23	22.5	21.8	20.8	19.5	18.3	16.8	15	13	

Q = Flow rate H = Total manometric head HS = Suction height

Tolerance of characteristic curves in compliance with EN ISO 9906 Grade 3B.

CHARACTERISTIC CURVES AND PERFORMANCE DATA

50 Hz n = 2900 min⁻¹ HS = 0 m

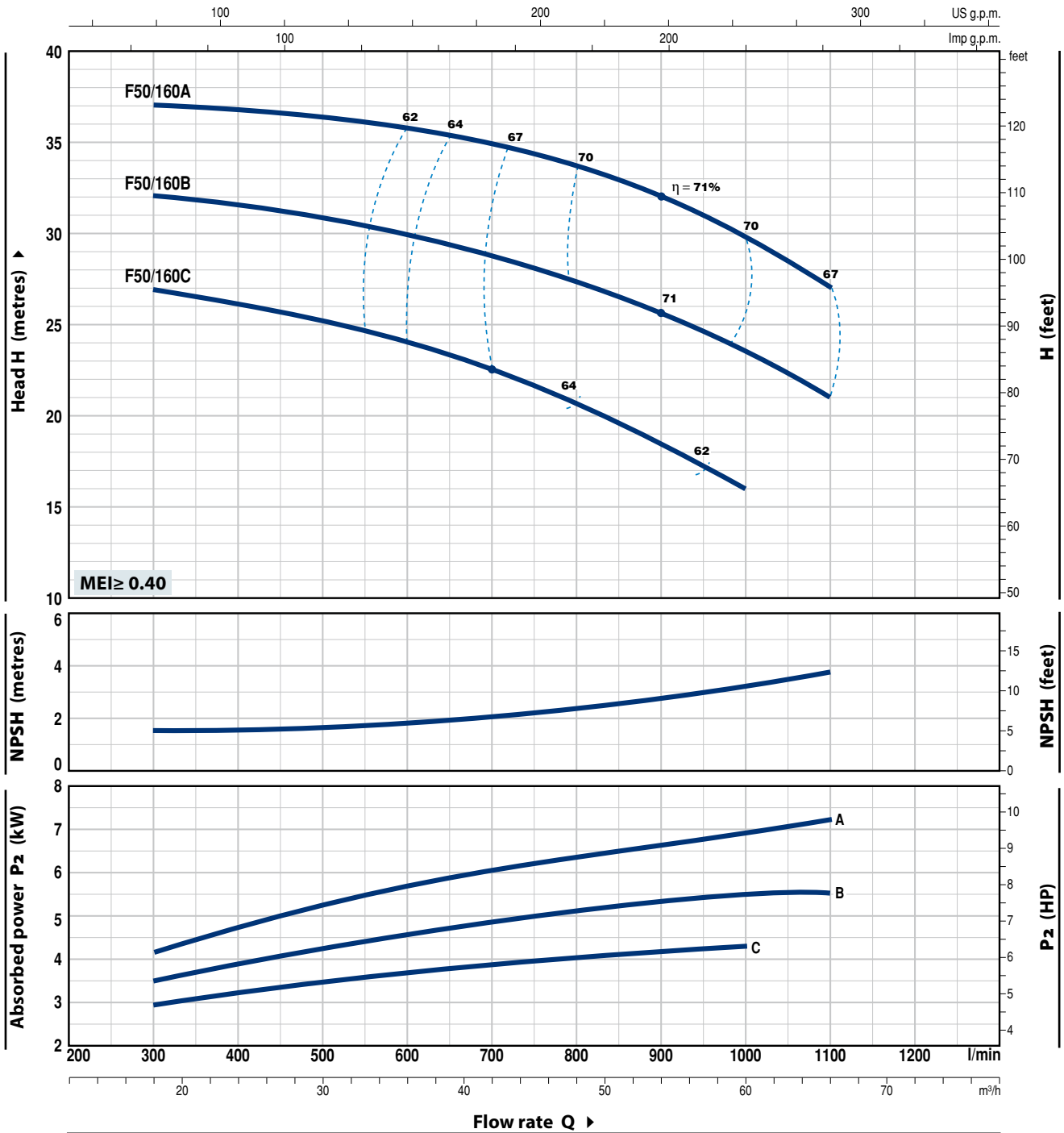

MODEL	POWER (P ₂)		Q	Flow rate											
	kW	HP		m ³ /h	0	18	24	30	36	42	48	54	60	66	
Three-phase			l/min	0	300	400	500	600	700	800	900	1000	1100		
F 50/160C	4	5.5	H metres	27	27	26.5	25	24.5	23	20	18.5	16			
F 50/160B	5.5	7.5		33	32	31.7	31	30	29	27	26	24	21		
F 50/160A	7.5	10		38	37	36.8	36.5	36	34	33	32	30	27		

Q = Flow rate H = Total manometric head HS = Suction height

Tolerance of characteristic curves in compliance with EN ISO 9906 Grade 3B.

F50/200

CHARACTERISTIC CURVES AND PERFORMANCE DATA

50 Hz n = 2900 min⁻¹ HS = 0 m

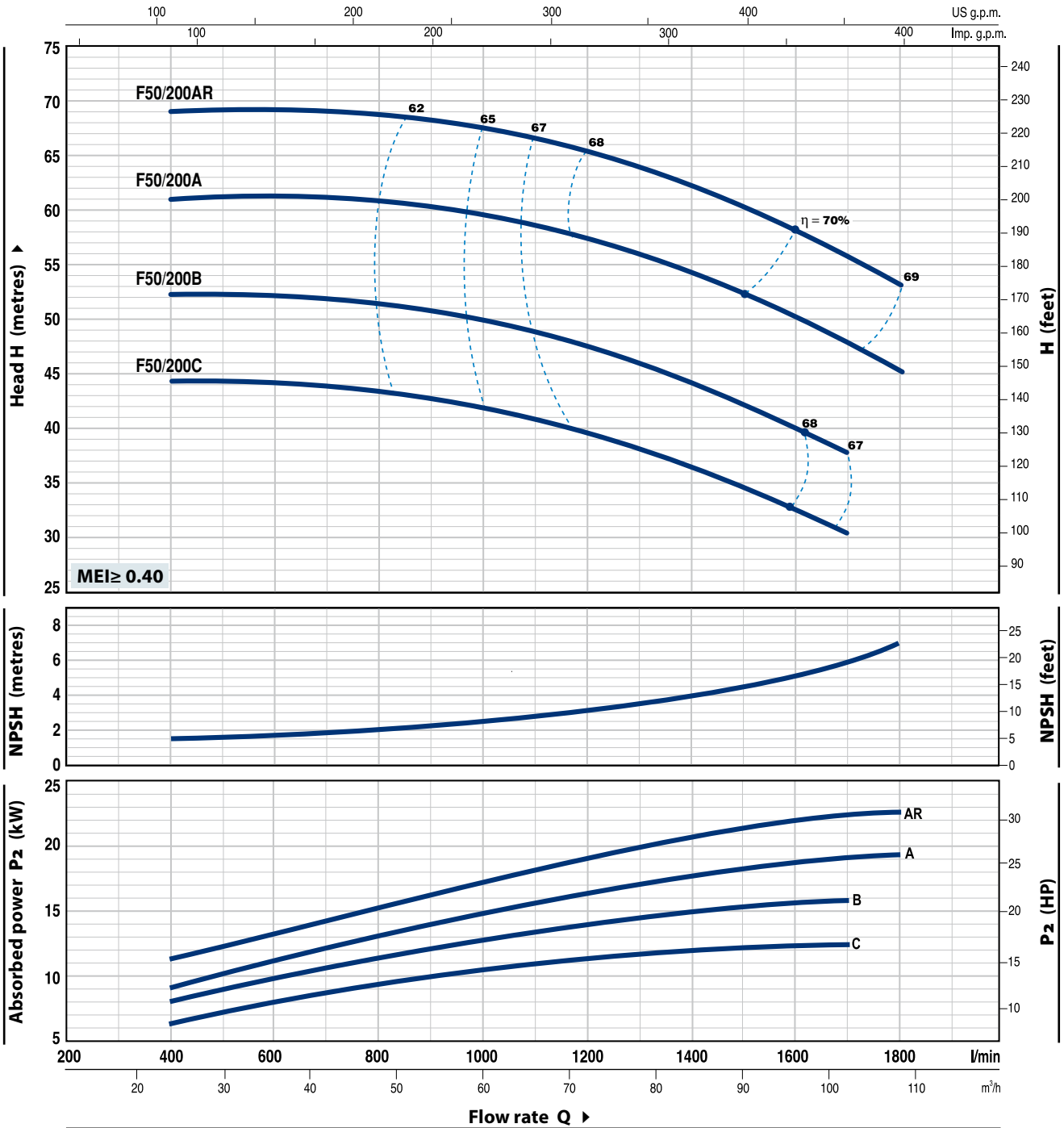

MODEL	POWER (P ₂)		Q	Flow rate Q										
	kW	HP		m ³ /h	24	36	48	60	72	84	96	102	108	
Three-phase			l/min	400	600	800	1000	1200	1400	1600	1700	1800		
F 50/200C	11	15	H metres	44	44	44	42	39	36	33	30			
F 50/200B	15	20		52	52	52	50	47	44	40	38			
F 50/200A	18.5	25		61	61	60.5	60	57	54	50	48	45		
F 50/200AR	22	30		69	69	68.5	68	65	62	58	56	53		

Q = Flow rate H = Total manometric head HS = Suction height

Tolerance of characteristic curves in compliance with EN ISO 9906 Grade 3B.

CHARACTERISTIC CURVES AND PERFORMANCE DATA

50 Hz n = 2900 min⁻¹ HS = 0 m

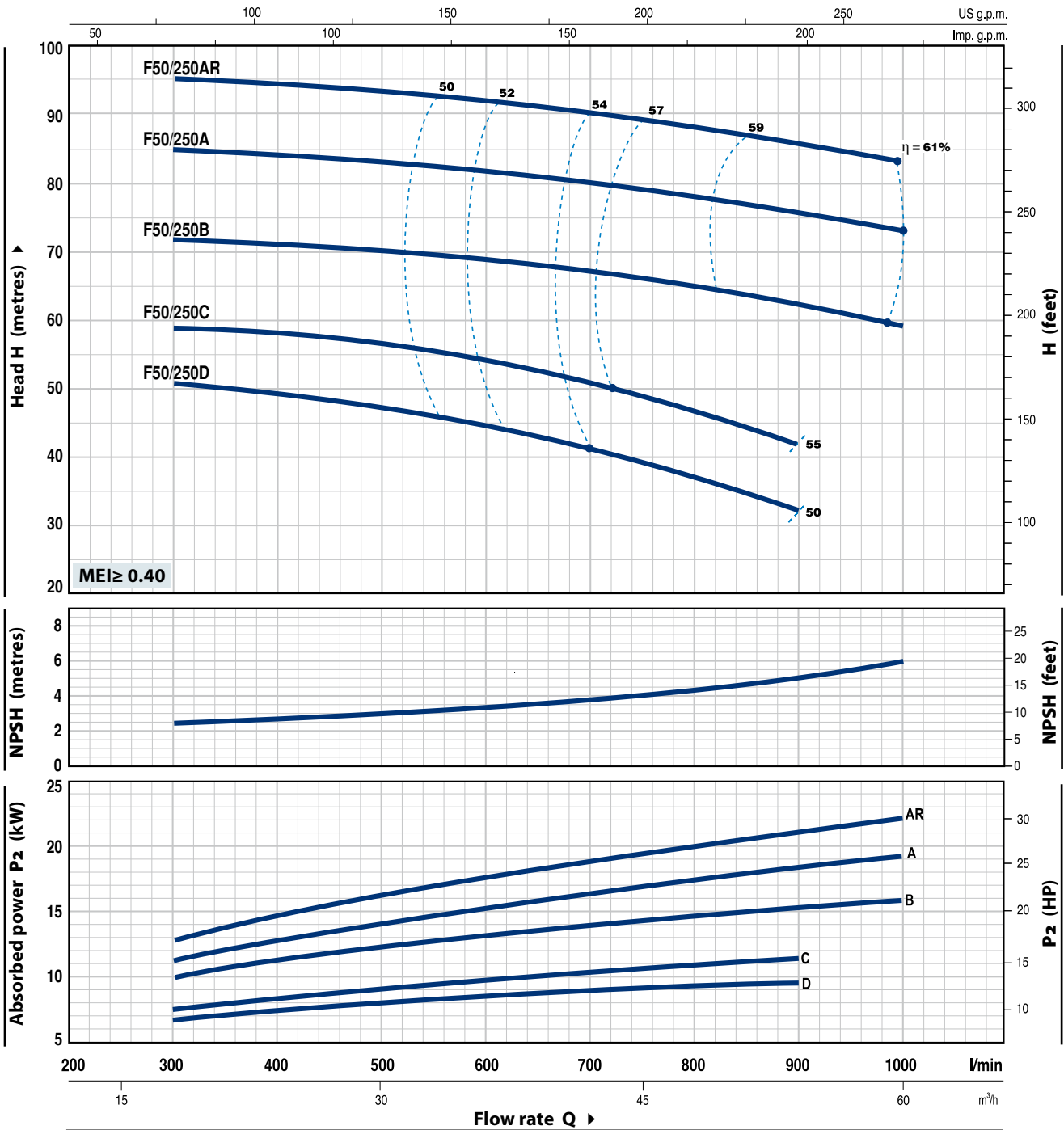

MODEL	POWER (P ₂)		Q	Flow rate										
	kW	HP		0	18	24	30	36	42	48	54	60		
Three-phase			l/min	0	300	400	500	600	700	800	900	1000		
F 50/250D	9.2	12.5	H metres	51	51	49	47	44	41	37	32			
F 50/250C	11	15		59	59	58	57	54	51	47	42			
F 50/250B	15	20		72	72	71	70	69	67	65	62	59		
F 50/250A	18.5	25		85	85	84	83	82	80	78	76	73		
F 50/250AR	22	30		95	95	94	93	92	90	88	86	83		

Q = Flow rate H = Total manometric head HS = Suction height

Tolerance of characteristic curves in compliance with EN ISO 9906 Grade 3B.

F65/125

CHARACTERISTIC CURVES AND PERFORMANCE DATA

50 Hz n= 2900 min⁻¹ HS= 0 m

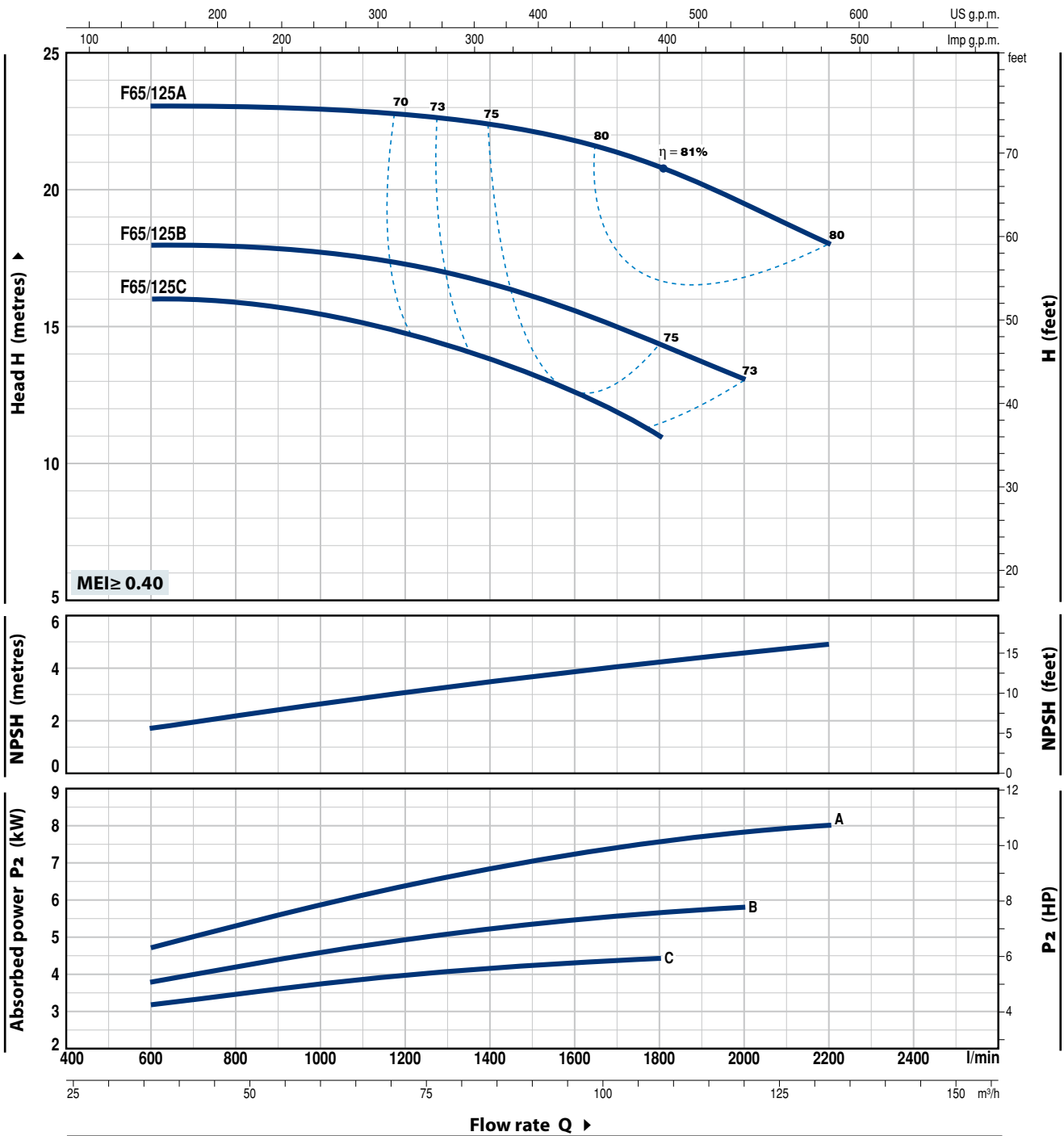

MODEL	POWER (P ₂)		Q	Flow rate Q												
	kW	HP		m ³ /h	0	36	48	60	72	84	96	108	120	132		
Three-phase			l/min	0	600	800	1000	1200	1400	1600	1800	2000	2200			
F 65/125C	4	5.5	H metres	16	16	16	15.5	14.5	13.5	12.5	11					
F 65/125B	5.5	7.5		18	18	18	18	17	16.5	15.5	14.5	13				
F 65/125A	7.5	10		23	23	23	23	22.5	22.5	22	21	19.5	18			

Q = Flow rate H = Total manometric head HS = Suction height

Tolerance of characteristic curves in compliance with EN ISO 9906 Grade 3B.

CHARACTERISTIC CURVES AND PERFORMANCE DATA

50 Hz n = 2900 min⁻¹ HS = 0 m

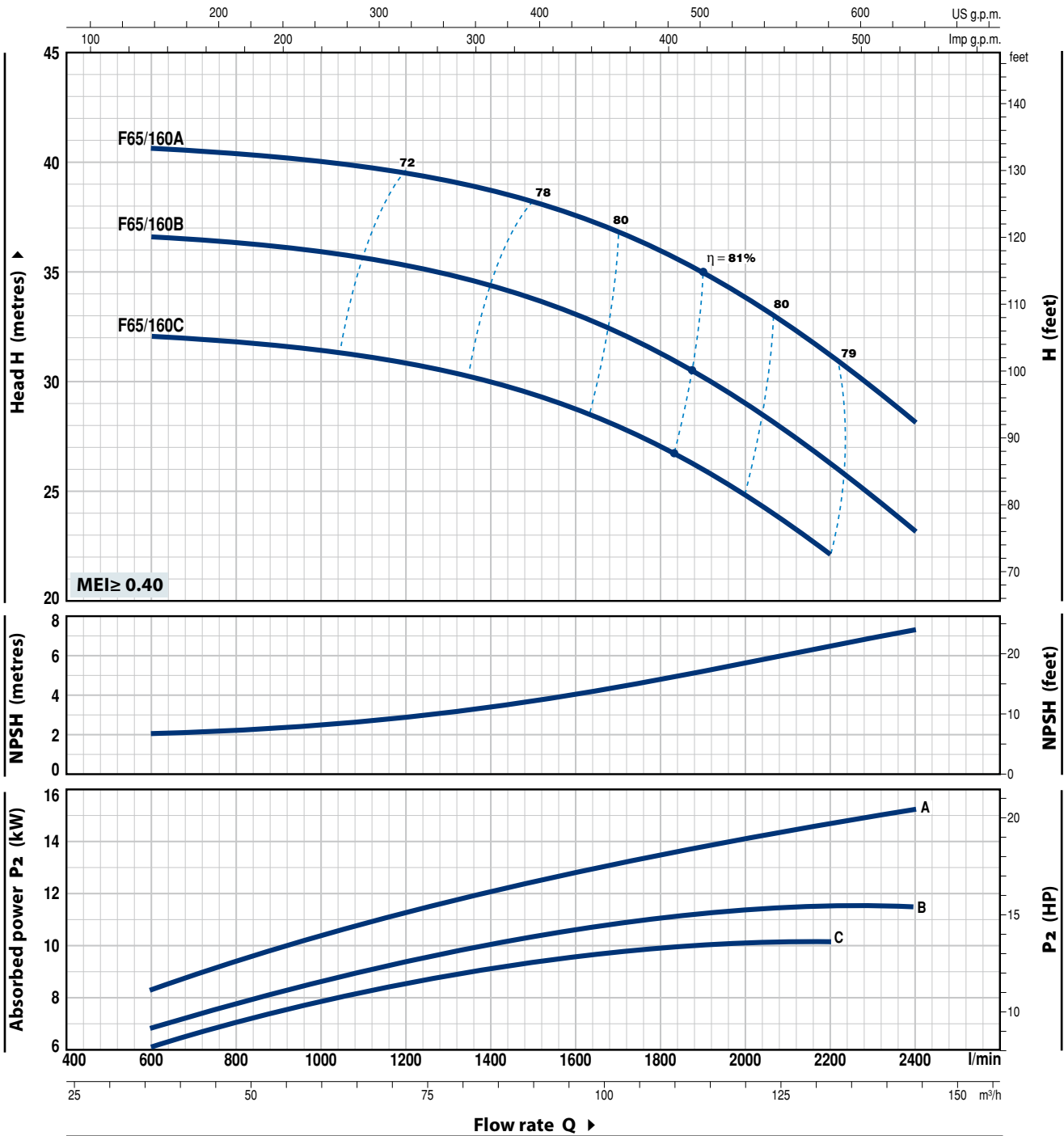

MODEL	POWER (P ₂)		Q	Flow rate													
	kW	HP		0	36	48	60	72	84	96	108	120	132	144			
Three-phase			l/min	0	600	800	1000	1200	1400	1600	1800	2000	2200	2400			
F 65/160C	9.2	12.5	H metres	32	32	32	32	32	30	29	27	25	22				
F 65/160B	11	15		37	36.5	36.5	36	35.5	34	33	31	29	26	23			
F 65/160A	15	20		41	40.5	40.5	40	39.5	39	37.5	36	34	31	28			

Q = Flow rate H = Total manometric head HS = Suction height

Tolerance of characteristic curves in compliance with EN ISO 9906 Grade 3B.

F65/200

CHARACTERISTIC CURVES AND PERFORMANCE DATA

50 Hz n = 2900 min⁻¹ HS = 0 m

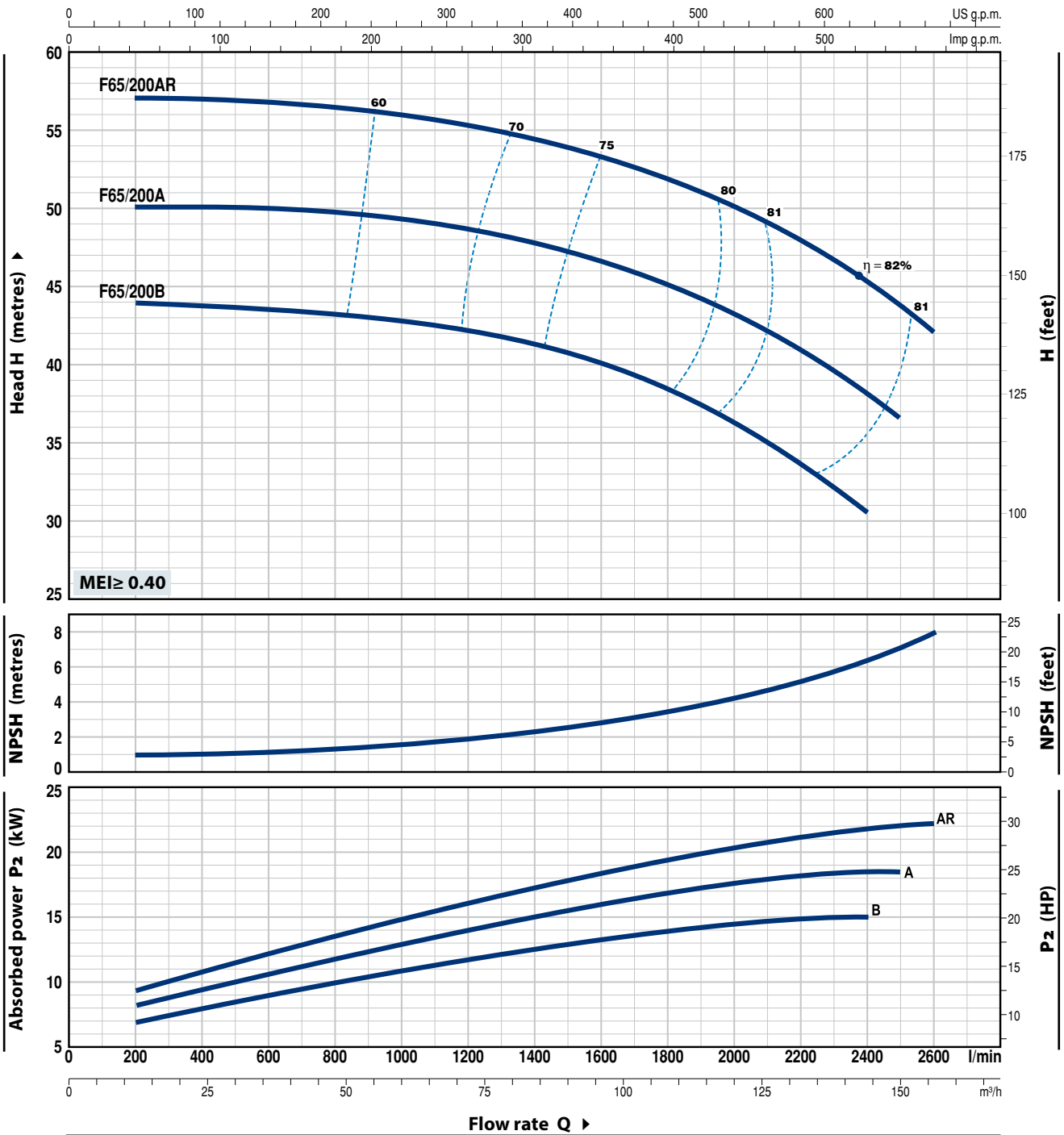

MODEL	POWER (P ₂)		Q m ³ /h l/min	Flow rate Q														
	kW	HP		12	36	48	60	72	84	96	108	120	132	144	150	156		
Three-phase				200	600	800	1000	1200	1400	1600	1800	2000	2200	2400	2500	2600		
F 65/200B	15	20	H metres	44	43.5	43.3	43	42.5	41.5	40	38.5	36.5	34	30.5				
F 65/200A	18.5	25		50	50	50	49.5	49	48	46.5	45	43	41	38	36.5			
F 65/200AR	22	30		57	57	57	56	55.5	54.5	53.5	52	50	48	45.5	43.5	42		

Q = Flow rate H = Total manometric head HS = Suction height

Tolerance of characteristic curves in compliance with EN ISO 9906 Grade 3B.

CHARACTERISTIC CURVES AND PERFORMANCE DATA

50 Hz n = 2900 min⁻¹ HS = 0 m

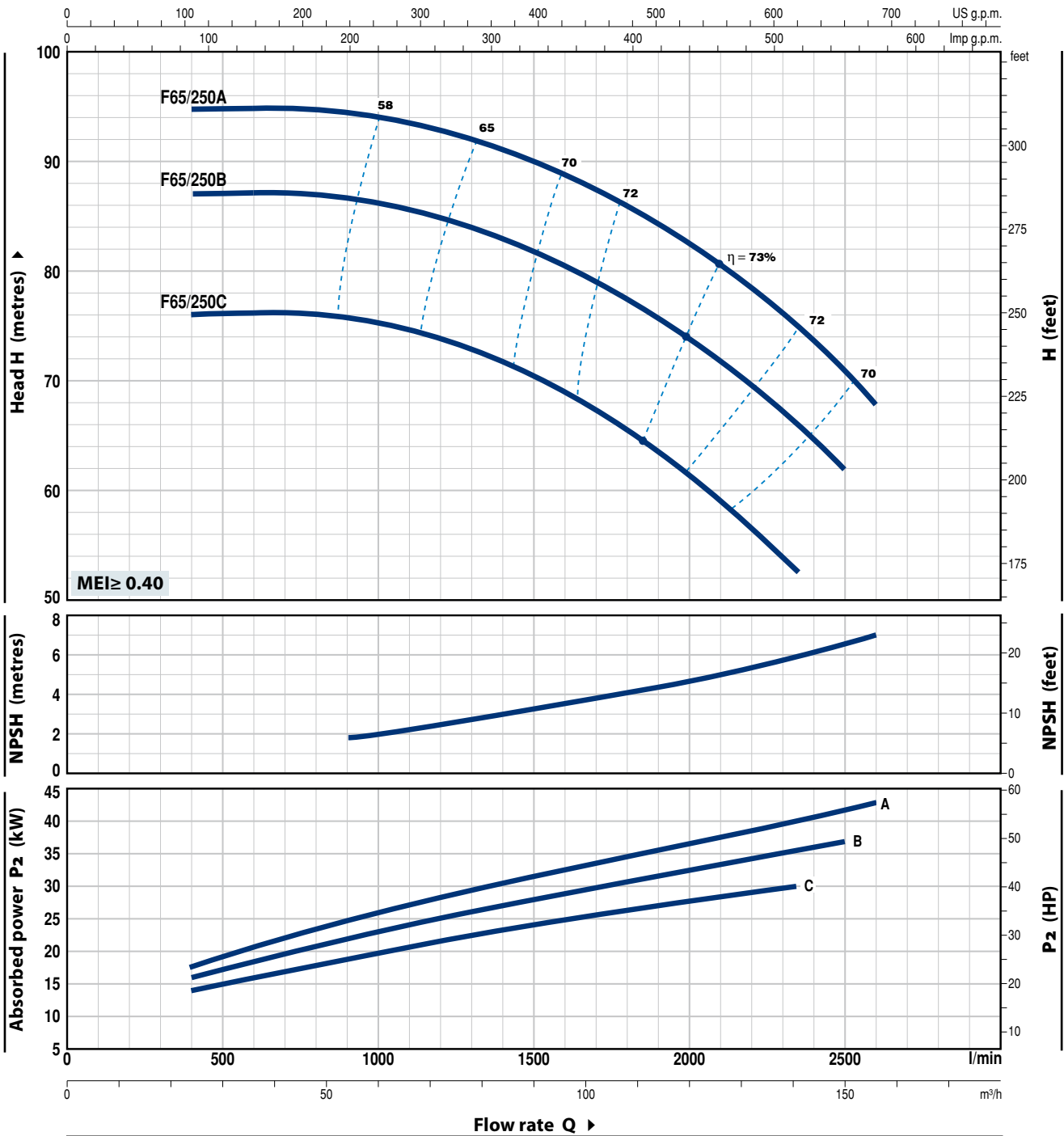

MODEL	POWER (P ₂)		Q	Flow rate											
	kW	HP		m ³ /h	24	40	60	80	100	120	141	150	156		
Three-phase			l/min	400	667	1000	1333	1667	2000	2350	2500	2600			
F 65/250C	30	40	H metres	76	76	75.5	72.5	68	61.5	53					
F 65/250B	37	50		87	87	86	84	80	74	66.5	62				
F 65/250A	45	60		95	95	94	92	88	82.5	75	71	68			

Q = Flow rate H = Total manometric head HS = Suction height

Tolerance of characteristic curves in compliance with EN ISO 9906 Grade 3B.

F80/160

CHARACTERISTIC CURVES AND PERFORMANCE DATA

50 Hz n = 2900 min⁻¹ HS = 0 m

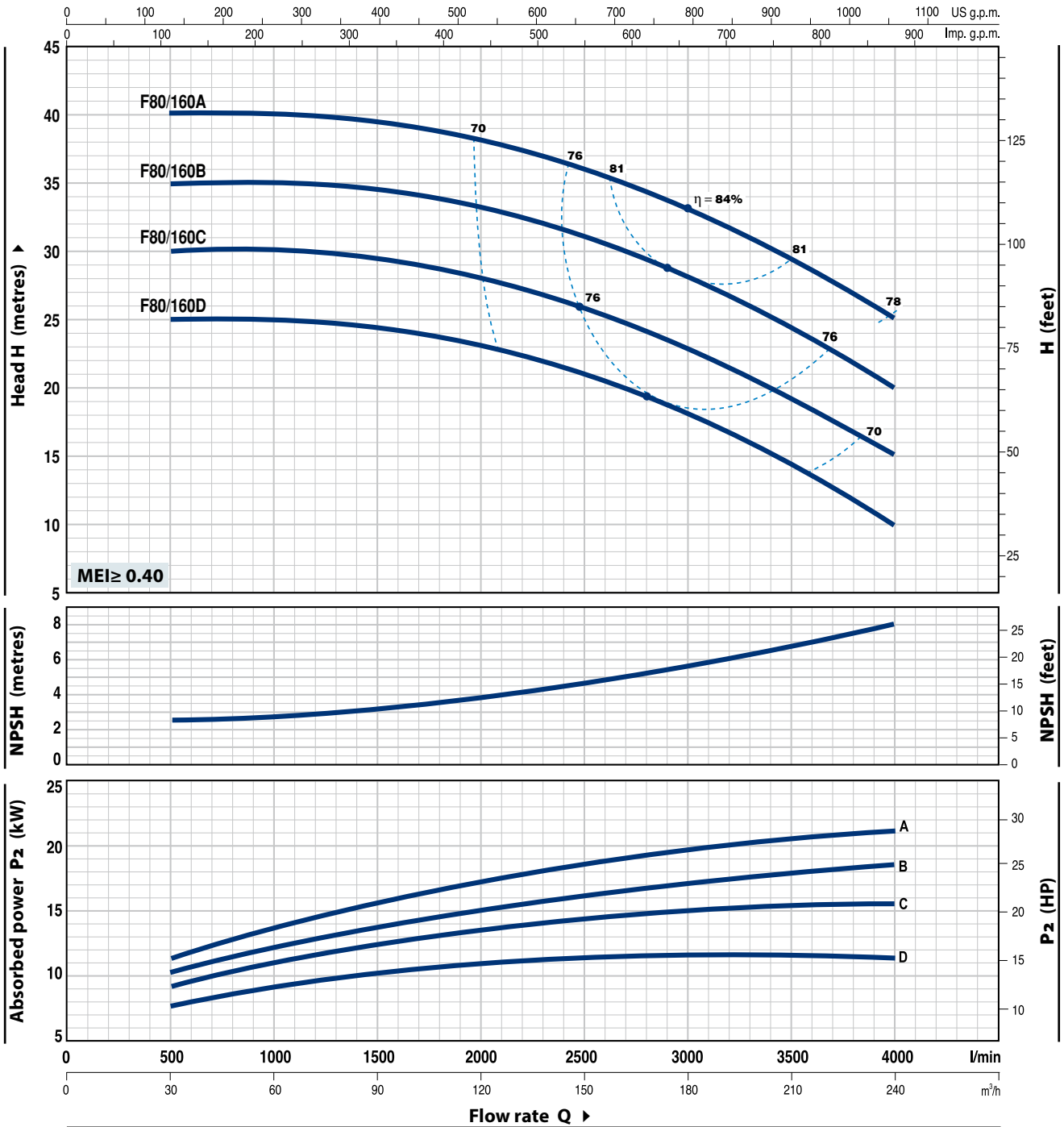

MODEL	POWER (P ₂)		Q	Flow rate Q											
	kW	HP		m ³ /h	0	30	60	90	120	150	180	210	240		
Three-phase			l/min	0	500	1000	1500	2000	2500	3000	3500	4000			
F 80/160D	11	15	H metres	25	25	25	24.5	23.5	21	18	14.5	10			
F 80/160C	15	20		30	30	30	29.5	28.5	26	23	19.5	15			
F 80/160B	18.5	25		35	35	35	34.5	33.5	31	28.5	24.5	20			
F 80/160A	22	30		40	40	40	39.5	38.5	36	33	29.5	25			

Q = Flow rate H = Total manometric head HS = Suction height

Tolerance of characteristic curves in compliance with EN ISO 9906 Grade 3B.

CHARACTERISTIC CURVES AND PERFORMANCE DATA

50 Hz n= 2900 min⁻¹ HS= 0 m

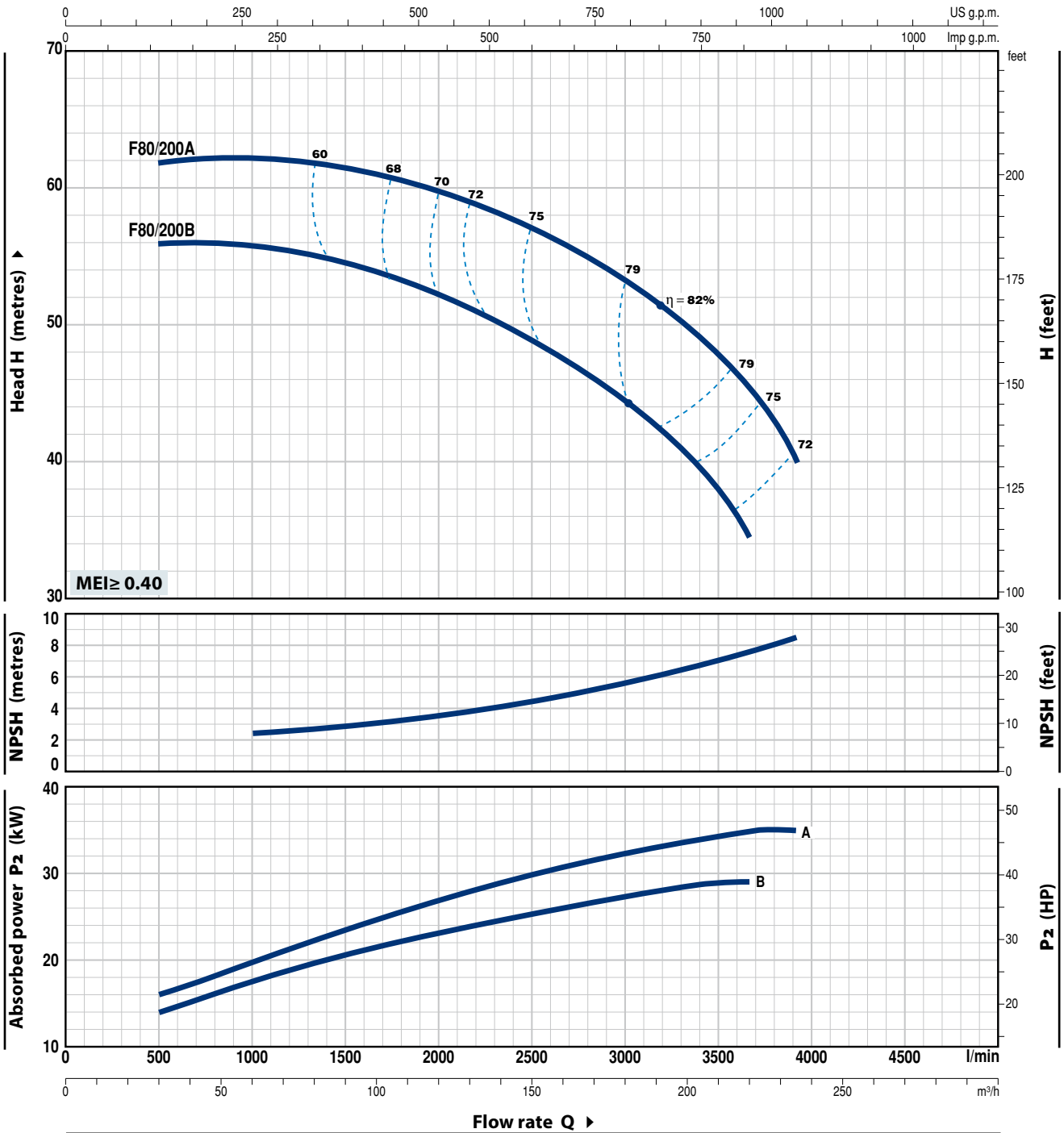

MODEL	POWER (P ₂)		Q	Flow rate						
	kW	HP		m ³ /h	l/min	m ³ /h	l/min	m ³ /h	l/min	
Three-phase				30	50	100	150	200	219	234
				500	833	1667	2500	3333	3650	3900
F 80/200B	30	40	H metres	56	56	54	49	41	34.5	
F 80/200A	37	50		62	62	61	57	50	45.5	40

Q =Flow rate H =Total manometric head HS = Suction height

Tolerance of characteristic curves in compliance with EN ISO 9906 Grade 3B.

F80/250

CHARACTERISTIC CURVES AND PERFORMANCE DATA

50 Hz n = 2900 min⁻¹ HS = 0 m

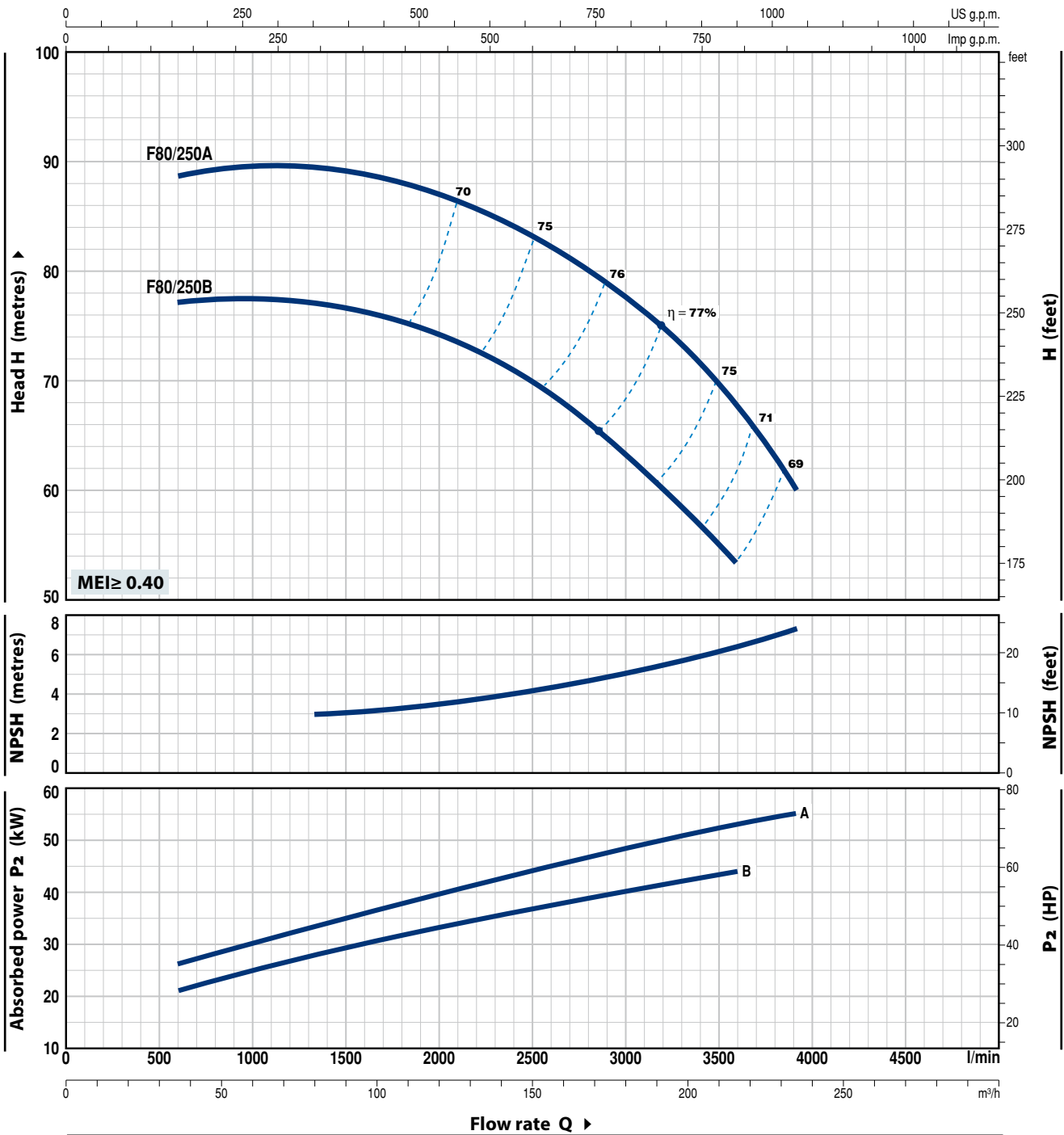

MODEL	POWER (P ₂)		Q	Flow rate Q						
	kW	HP		m ³ /h	l/min	m ³ /h	l/min	m ³ /h	l/min	
Three-phase				36	50	100	150	200	216	234
F 80/250B	45	60	H metres	77	77.5	76	70.5	58.5	54	
F 80/250A	55	75	H metres	88.5	89.5	89	83	72	68	60

Q = Flow rate H = Total manometric head HS = Suction height

Tolerance of characteristic curves in compliance with EN ISO 9906 Grade 3B.

CHARACTERISTIC CURVES AND PERFORMANCE DATA

50 Hz n = 2900 min⁻¹ HS = 0 m

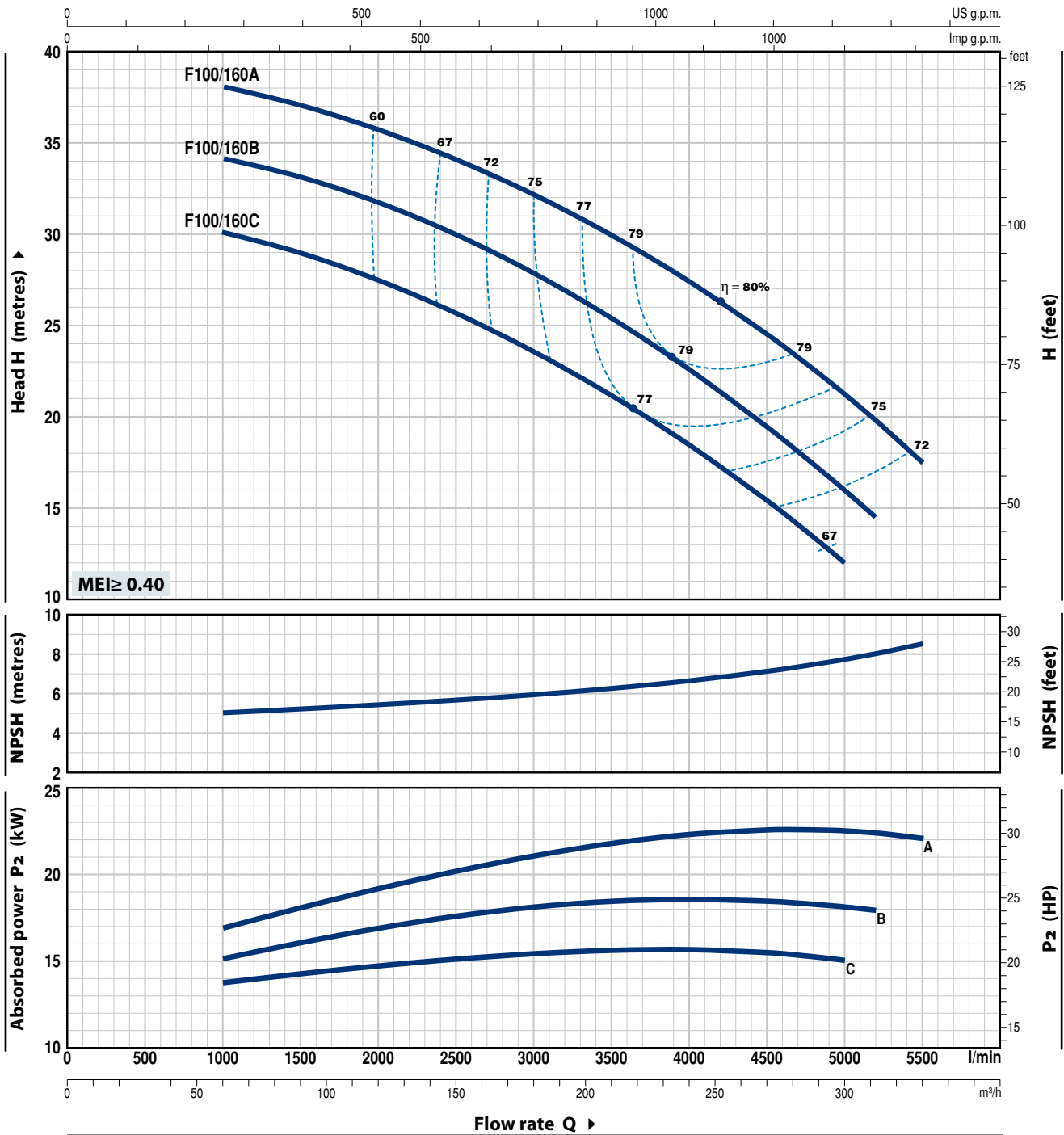

MODEL	POWER (P ₂)		Q m ³ /h l/min	60	90	120	150	180	210	240	270	300	312	330
	kW	HP		1000	1500	2000	2500	3000	3500	4000	4500	5000	5200	5500
F 100/160C	15	20	H metres	30	29	27.5	25.5	23.5	21	18.5	15.5	12		
F 100/160B	18.5	25		34	33	31.5	30	28	25.5	22.5	19.5	16	14.5	
F 100/160A	22	30		38	37	36	34	32	30	27.5	24.5	21	20	17.5

Q = Flow rate H = Total manometric head HS = Suction height

Tolerance of characteristic curves in compliance with EN ISO 9906 Grade 3B.

F100/200

CHARACTERISTIC CURVES AND PERFORMANCE DATA

50 Hz n = 2900 min⁻¹ HS = 0 m

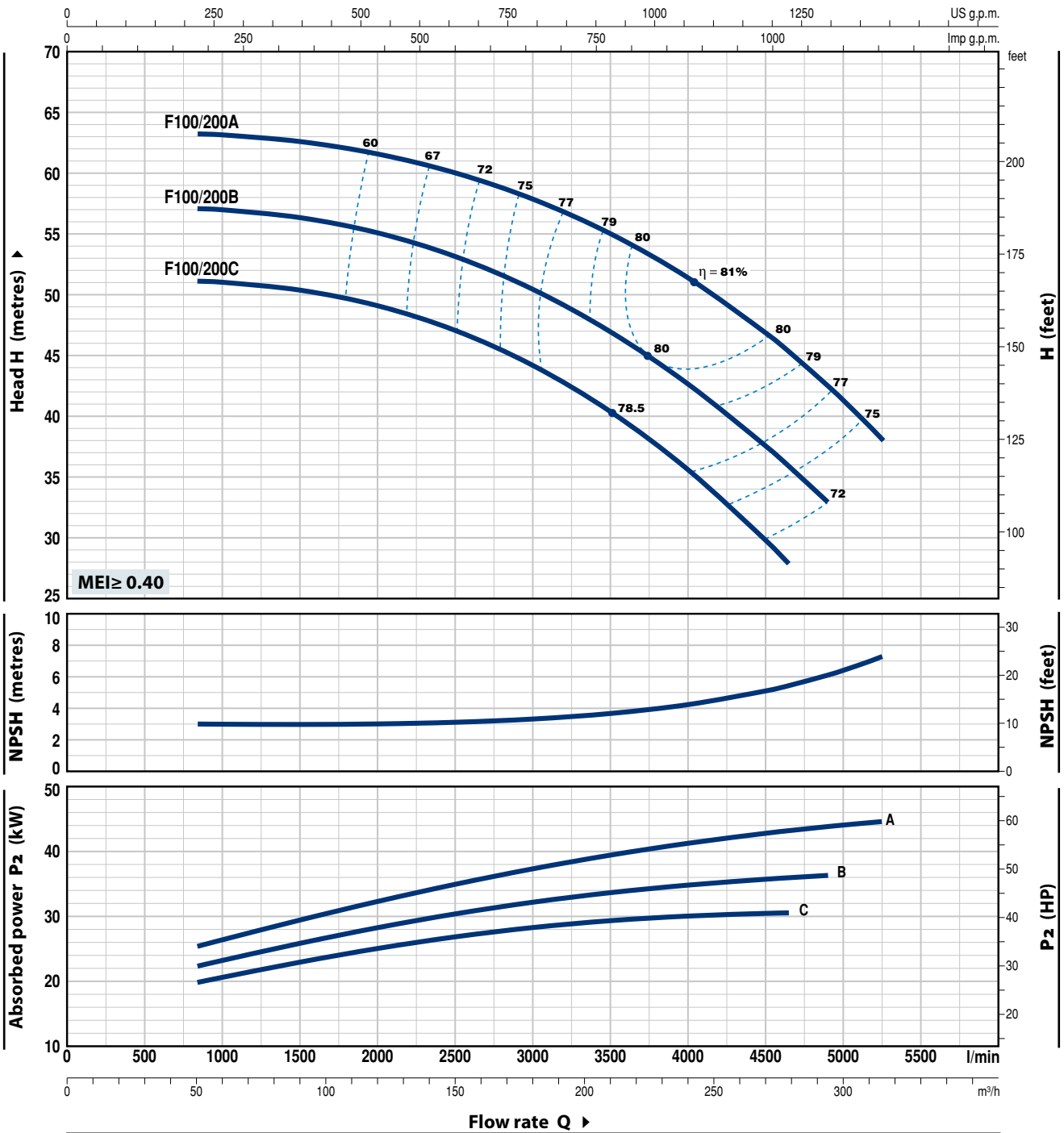

MODEL	POWER (P ₂)		Q	Flow rate Q												
	kW	HP		0	50	96	150	180	210	240	279	294	300	315		
Three-phase			l/min	0	833	1600	2500	3000	3500	4000	4650	4900	5000	5250		
F 100/200C	30	40	H metres	51	51	50	47	44	40.5	35.5	28					
F 100/200B	37	50		57	57	56	53	50.5	47	42.5	36	33				
F 100/200A	45	60		63	63	62.5	60	58	55	51.5	45	42.5	41.5	38		

Q = Flow rate H = Total manometric head HS = Suction height

Tolerance of characteristic curves in compliance with EN ISO 9906 Grade 3B.

CHARACTERISTIC CURVES AND PERFORMANCE DATA

50 Hz n = 2900 min⁻¹ HS = 0 m

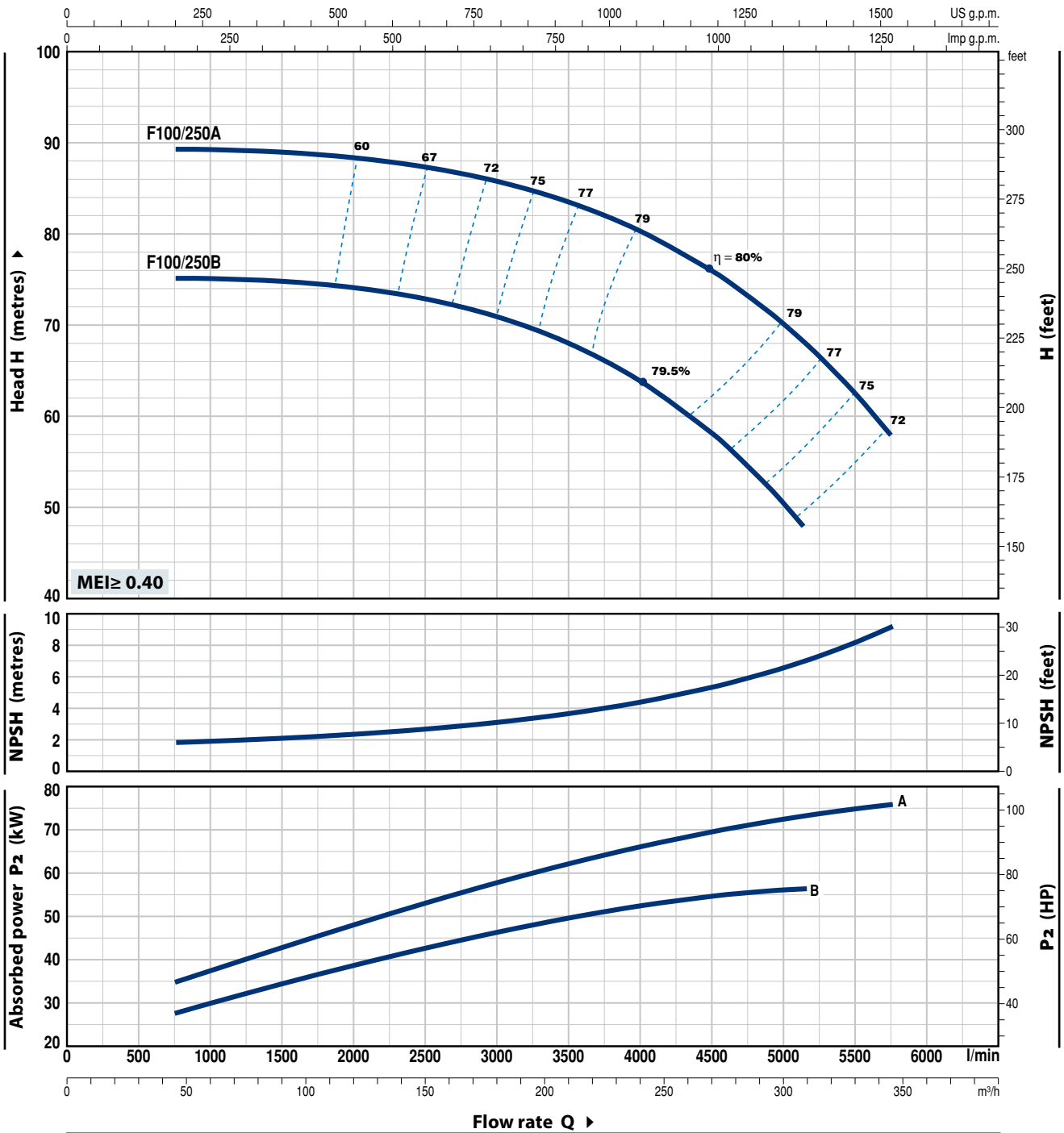

MODEL	POWER (P ₂)		Q	Flow rate										
	kW	HP		m ³ /h	48	96	150	180	210	240	300	309	345	
Three-phase			l/min	800	1600	2500	3000	3500	4000	5000	5150	5750		
F 100/250B	55	75	H metres	75	75	73	71	68	64	50.5	48			
F 100/250A	75	100		89	89	87.5	86	83.5	80.5	70	68	58		

Q = Flow rate H = Total manometric head HS = Suction height

Tolerance of characteristic curves in compliance with EN ISO 9906 Grade 3B.

POS. COMPONENT CONSTRUCTION CHARACTERISTICS

1 PUMP BODY	Cast iron complete with flanged suction and delivery ports				
2a BODY BACKPLATE	Cast iron for F32/160, F32/200, F40/125, F40/160, F40/200, F50/125, F50/160, F65/125				
2b MOTOR BRACKET	Cast iron for F32/250, F40/250, F50/200, F50/250, F65/160, F65/200, F65/250, F80/160, F80/200, F80/250, F100/160, F100/200, F100/250				
3 IMPELLER	Brass for F32/160, F32/200, F40/125, F40/160, F40/200, F50/125, F50/160 Cast iron for F32/250, F40/250, F50/200, F50/250, F65/125, F65/160, F65/200, F65/250, F80/160, F80/200, F80/250, F100/160, F100/200, F100/250				
4 MOTOR SHAFT	Stainless steel AISI 431				
5 MECHANICAL SEAL	Pump Model	Seal Model	Shaft Diameter	Materials Stationary ring Rotational ring Elastomer	
	F32/160, F40/125, F40/160, F50/125	FN-20	Ø 20 mm	Graphite	Ceramic NBR
	F32/200, F40/200, F50/160, F65/125	FN-24	Ø 24 mm	Graphite	Ceramic NBR
	F50/200, F65/160, F65/200, F80/160, F100/160	FN-32 NU	Ø 32 mm	Graphite	Ceramic NBR
	F32/250, F40/250, F50/250	FN-38	Ø 38 mm	Graphite	Ceramic NBR
	F65/250, F80/200, F80/250B, F100/200	FN-40 NU	Ø 40 mm	Graphite	Ceramic NBR
	F80/250A, F100/250	FH-45 NU	Ø 45 mm	Graphite	Ceramic NBR
6 BEARINGS	Pump Model	Model	Pump Model	Model	
	F32/160C F40/160C	6206 ZZ-C3 / 6204 ZZ	F32/250 F50/200	6310 ZZ-C3 / 6308 ZZ-C3	
	F32/160B F50/125C		F40/250 F65/160		
	F40/125		F50/250 F80/160		
	Fm32/160B F32/160A	6206 ZZ-C3 / 6205 ZZ	F65/200 F100/160	6312 ZZ-C3 / 6212 ZZ-C3	
	Fm40/160C F40/160B		F65/250 F80/200		
	Fm50/125C F50/125B		F80/250B F100/200		
	F40/160A	6306 ZZ-C3 / 6206 ZZ-C3	F80/250A	6314 ZZ-C3 / 6313 ZZ-C3	
	F50/125A		F100/250		
	F32/200 F40/200	6307 ZZ-C3 / 6206 ZZ-C3			
	F50/160 F65/125				
7 CAPACITOR	Pump	Capacitance			
	Single-phase	(230 V or 240 V)			
	Fm32/160C	45 µF - 450 VL			
	Fm32/160B	70 µF - 450 VL			
	Fm40/125C	31.5 µF - 450 VL			
	Fm40/125B	45 µF - 450 VL			
	Fm40/160C	70 µF - 450 VL			
	Fm50/125C	70 µF - 450 VL			
8 ELECTRIC MOTOR	Fm: single-phase 230 V - 50 Hz with thermal overload protector incorporated into the winding (up to 1.5 kW) F: three-phase 230/400 V - 50 Hz up to 4 kW 400/690 V - 50 Hz from 5.5 to 75 kW <ul style="list-style-type: none"> ➡ The three-phase pumps are fitted with high performance motors in class IE3 (IEC 60034-30-1) - Insulation: class F - Protection: IP 55 				

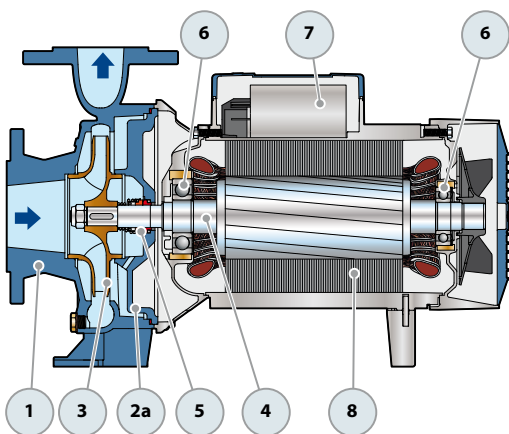

Single-phase version

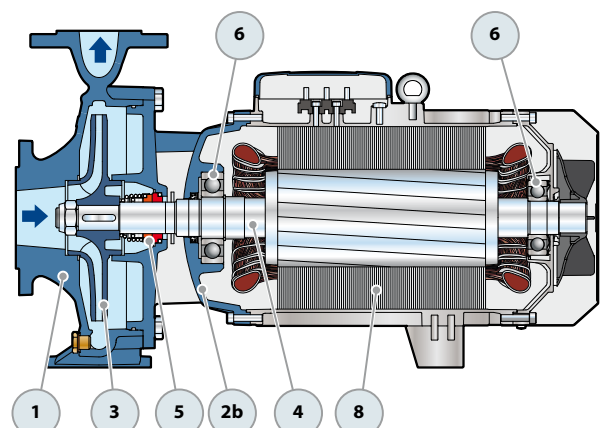

Three-phase version

ABSORPTION

MODEL	VOLTAGE	
	230 V	240 V
Single-phase		
Fm 32/160C	11.0 A	10.0 A
Fm 32/160B	15.0 A	13.8 A
Fm 40/160C	15.0 A	14.4 A
Fm 50/125C	15.0 A	14.4 A

MODEL	VOLTAGE		
	230–240 V	400–415 V	690–720 V
Three-phase			
F 32/160C	7.5 A	4.3 A	2.5 A
F 32/160B	8.65 A	5.0 A	2.9 A
F 32/160A	12.6 A	7.3 A	4.1 A
F 32/200C	17.9 A	10.3 A	6.0 A
F 32/200B	–	11.7 A	6.8 A
F 32/200A	–	14.9 A	8.6 A
F 32/200BH	12.6 A	7.3 A	4.2 A
F 32/200AH	15.4 A	8.9 A	5.1 A
F 32/250C	–	18.5 A	10.7 A
F 32/250B	–	22.0 A	12.7 A
F 32/250A	–	25.0 A	14.5 A
F 40/125C	5.2 A	3.0 A	1.7 A
F 40/125B	7.7 A	4.5 A	2.6 A
F 40/125A	9.0 A	5.2 A	3.0 A
F 40/160C	9.9 A	5.7 A	3.3 A
F 40/160B	12.0 A	6.9 A	4.0 A
F 40/160A	17.2 A	9.9 A	5.6 A
F 40/200B	–	12.6 A	7.3 A
F 40/200A	–	15.6 A	9.0 A
F 40/250C	–	21.0 A	12.1 A
F 40/250B	–	23.5 A	13.6 A
F 40/250A	–	30.5 A	17.6 A
F 50/125C	9.4 A	5.4 A	3.2 A
F 50/125B	12.0 A	6.9 A	4.0 A
F 50/125A	16.3 A	9.4 A	5.4 A
F 50/160C	15.8 A	9.1 A	5.3 A
F 50/160B	–	12.3 A	7.1 A
F 50/160A	–	15.5 A	8.9 A
F 50/200C	–	23.0 A	13.3 A
F 50/200B	–	29.5 A	17.0 A
F 50/200A	–	34.5 A	20.0 A
F 50/200AR	–	41.5 A	24.0 A

MODEL	VOLTAGE		
	230–240 V	400–415 V	690–720 V
Three-phase			
F 50/250D	–	19.0 A	11.0 A
F 50/250C	–	21.0 A	12.0 A
F 50/250B	–	27.0 A	15.6 A
F 50/250A	–	34.0 A	19.6 A
F 50/250AR	–	41.0 A	24.0 A
F 65/125C	17.5 A	10.0 A	5.8 A
F 65/125B	–	12.0 A	7.0 A
F 65/125A	–	16.5 A	9.5 A
F 65/160C	–	19.0 A	11.0 A
F 65/160B	–	23.0 A	13.5 A
F 65/160A	–	27.5 A	16.0 A
F 65/200B	–	30.0 A	17.3 A
F 65/200A	–	34.0 A	19.5 A
F 65/200AR	–	41.0 A	24.0 A
F 65/250C	–	53.0 A	31.0 A
F 65/250B	–	65.0 A	38.0 A
F 65/250A	–	79.0 A	46.0 A
F 80/160D	–	22.0 A	13.0 A
F 80/160C	–	29.0 A	17.0 A
F 80/160B	–	34.5 A	20.0 A
F 80/160A	–	39.0 A	22.5 A
F 80/200B	–	53.0 A	31.0 A
F 80/200A	–	65.0 A	38.0 A
F 80/250B	–	79.0 A	46.0 A
F 80/250A	–	98.0 A	57.0 A
F 100/160C	–	27.5 A	16.0 A
F 100/160B	–	32.5 A	18.8 A
F 100/160A	–	39.8 A	23.0 A
F 100/200C	–	53.0 A	31.0 A
F 100/200B	–	65.0 A	38.0 A
F 100/200A	–	79.0 A	46.0 A
F 100/250B	–	98.0 A	57.0 A
F 100/250A	–	126.0 A	73.0 A

DIMENSIONS AND WEIGHT

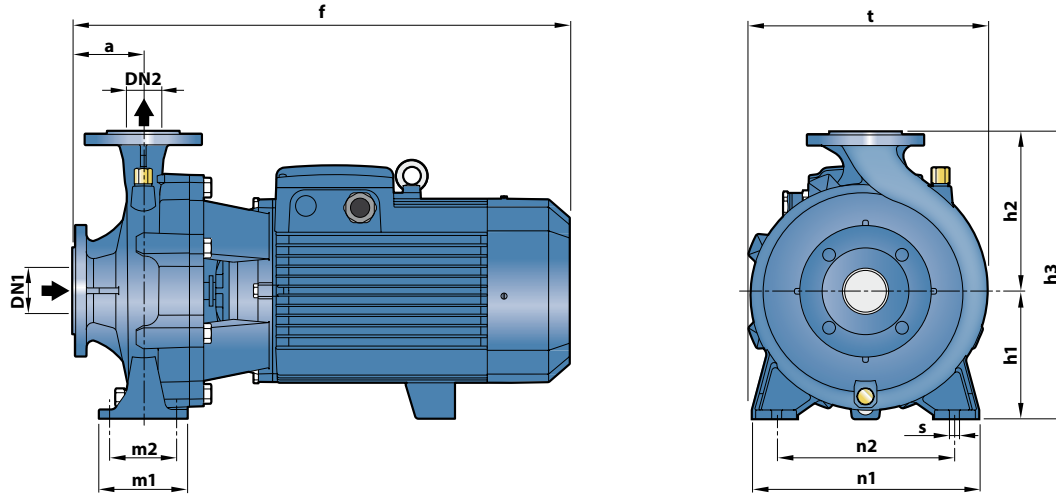

MODEL		DIMENSIONS mm													kg	
Single-phase	Three-phase	DN1	DN2	a	f	h1	h2	h3	t	n1	n2	m1	m2	s	1~	3~
Fm 32/160C	F 32/160C	50	32	80	419	132	160	292	240	245	190	100	70	14	32.6	32.3
Fm 32/160B	F 32/160B				448/432										42.3	35.2
-	F 32/160A				448										-	38.7
-	F 32/200C				469										-	46.3
-	F 32/200B				515										-	51.8
-	F 32/200A				469										-	56.9
-	F 32/200BH			-	-	-	-	42.0								
-	F 32/200AH			-	-	-	-	45.8								
-	F 32/250C			-	-	-	-	105.5								
-	F 32/250B			100	606	180	225	405	325	320	250	125	95		-	103.2
-	F 32/250A			701	-	-	-	-	-	-	-	-	-		-	121.0
Fm 40/125C	F 40/125C			65	40	80	421	112	140	252	244	210	160		100	70
Fm 40/125B	F 40/125B	441	33.0				32.4									
-	F 40/125A	439	-				32.6									
Fm 40/160C	F 40/160C	448	-				38.3									
-	F 40/160B	465	-				38.9									
-	F 40/160A	535	-				43.6									
-	F 40/200B	-	-			-	-	53.0								
-	F 40/200A	-	-			-	-	59.0								
-	F 40/250C	-	-			-	-	104.0								
-	F 40/250B	606	180			225	405	329	320	250	125	95	-	104.0		
-	F 40/250A	701	-			-	-	-	-	-	-	-	-	-	120.0	
Fm 50/125C	F 50/125C	65	50			100	465/451	132	160	292	242	240	190	100	70	14
-	F 50/125B			465	-		38.5									
-	F 50/125A			484	-		42.8									
-	F 50/160C			489	-		47.3									
-	F 50/160B			535	-		52.8									
-	F 50/160A			616	-		57.6									
-	F 50/200C			-	-	-	-	100.0								
-	F 50/200B			-	-	-	-	115.0								
-	F 50/200A			711	200	360	316.5	-	-	-	-	-	-	127.2		
-	F 50/200AR			743	-	-	-	-	-	-	-	-	-	-	141.0	
-	F 50/250D			605	-	-	-	-	-	-	-	-	-	-	104.2	
-	F 50/250C			-	-	-	-	-	-	-	-	-	-	-	105.0	
-	F 50/250B	701	180	225	405	333	320	250	-	-	-	-	121.0			
-	F 50/250A	733	-	-	-	-	-	-	-	-	-	-	134.2			
-	F 50/250AR	733	-	-	-	-	-	-	-	-	-	-	147.0			
-	F 65/125C	511	-	-	-	-	-	-	-	-	-	-	53.2			
-	F 65/125B	-	-	-	-	180	340	292	-	-	-	-	58.3			
-	F 65/125A	557	-	-	-	-	-	-	280	212	-	-	63.0			
-	F 65/160C	-	-	-	-	160	-	-	-	-	125	95	98.5			
-	F 65/160B	620	-	-	-	200	360	295	-	-	-	-	100.2			
-	F 65/160A	716	-	-	-	-	-	-	-	-	-	-	114.0			
-	F 65/200B	-	-	-	-	-	-	-	-	-	-	-	119.3			
-	F 65/200A	718	-	-	-	-	-	-	336	-	-	-	132.1			
-	F 65/200AR	751	-	-	-	-	-	-	-	-	-	-	145.3			
-	F 80/160D	652	180	225	405	-	-	-	320	250	-	-	103.1			
-	F 80/160C	-	-	-	-	-	-	-	-	-	-	-	120.0			
-	F 80/160B	747	-	-	-	-	-	-	330	-	-	-	133.8			
-	F 80/160A	779	-	-	-	-	-	-	-	-	-	-	144.0			
-	F 100/160C	-	-	-	-	-	-	-	-	-	-	-	141.2			
-	F 100/160B	760	200	280	480	-	-	-	360	280	160	120	18	150.3		
-	F 100/160A	790	-	-	-	-	-	-	-	-	-	-	-	164.0		

DIMENSIONS AND WEIGHT

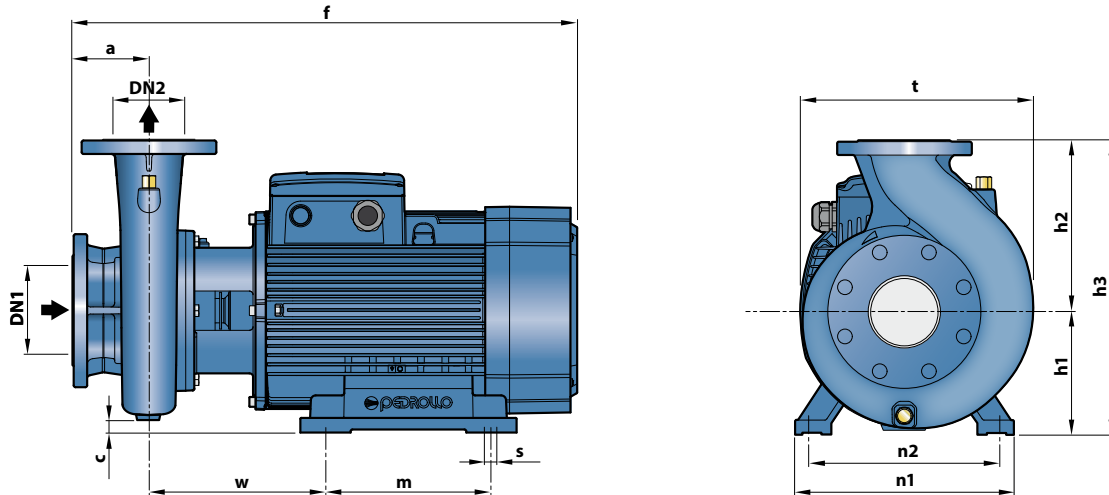

MODEL	DIMENSIONS mm														kg	
	Three-phase	DN1	DN2	a	f	h1	h2	h3	c	t	n1	n2	w	m		s
F 65/250C	80	65	100	796	201	250	451	16	363	360	318	269.5	305	18.5	208.0	
F 65/250B				847												
F 65/250A				847												
F 80/200B	100	80	125	824	280	280	450	26	360	490	400	294	350	24	197.4	
F 80/200A				875												
F 80/250B				872												
F 80/250A	125	100	140	1015	250	280	620	55	490	485	406	313	350	24	547.0	
F 100/200C				826												
F 100/200B				875												
F 100/200A	125	100	140	877	201	280	481	0	391	360	318	271	305	18.5	232.8	
F 100/250B				877												
F 100/250A																551.2
																544.3

FLANGED PORTS

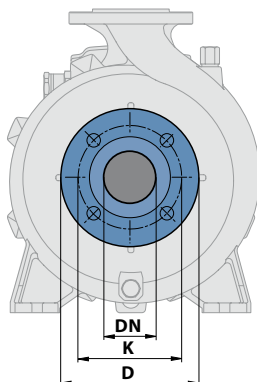

COUNTER FLANGES

(CAN BE ORDERED SEPARATELY)

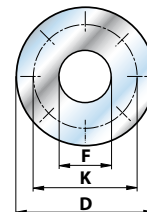

DN FLANGES	D	K	HOLES	
			N°	Ø (mm)
32	140	100	4	18
40	150	110		
50	165	125		
65	185	145		
80	200	160		
100	220	180	8	18
125	250	210		

DN FLANGES	F	D	K	HOLES	
				N°	Ø (mm)
32	1 1/4"	140	100	4	18
40	1 1/2"	150	110		
50	2"	165	125		
65	2 1/2"	185	145		
80	3"	200	160		
100	4"	220	180	8	18
125	5"	250	210		