



Pact series

ComPact NS

Catalogue 2020

Circuit breakers and switch-disconnectors
from 630b to 3200 A



se.com

Life Is On

Schneider
Electric



Green Premium™

An industry leading portfolio of offers delivering sustainable value



More than 75% of our product sales offer superior transparency on the material content, regulatory information and environmental impact of our products:

- RoHS compliance
- REACH substance information
- Industry leading # of PEP's*
- Circularity instructions

The Green Premium program stands for our commitment to deliver customer valued sustainable performance. It has been upgraded with recognized environmental claims and extended to cover all offers including Products, Services and Solutions.

CO₂ and P&L impact through... Resource Performance

Green Premium brings improved resource efficiency throughout an asset's lifecycle. This includes efficient use of energy and natural resources, along with the minimization of CO₂ emissions.

Cost of ownership optimization through... Circular Performance

We're helping our customers optimize the total cost of ownership of their assets. To do this, we provide IoT-enabled solutions, as well as upgrade, repair, retrofit, and remanufacture services.

Peace of mind through... Well-being Performance

Green Premium products are RoHS and REACH compliant. We're going beyond regulatory compliance with step-by-step substitution of certain materials and substances from our products.

Improved sales through... Differentiation

Green Premium delivers strong value propositions through third-party labels and services. By collaborating with third-party organizations we can support our customers in meeting their sustainability goals such as green building certifications.



Discover what we mean by green

[Check your products!](#)

*PEP: Product Environmental Profile (i.e. Environmental Product Declaration)

Life Is On

Schneider
Electric



ComPact NS

Molded case circuit breakers

The world is becoming more electric, digitized and decarbonized. Our digitized LV products are powered by innovation at every level enabling enhanced connectivity, real-time operations and smart analytics. They bring improved safety and security. They help you to improve reliability and performance – and to prepare for the future of power distribution.

ComPact is an integral part of EcoStruxure™ Power – Schneider's open, interoperable, IoT-enabled system architecture. Through this platform, we deliver enhanced value around safety, reliability, efficiency, sustainability, and connectivity for our customers. We leverage technologies in IoT, mobility, sensing, cloud, analytics, and cybersecurity to deliver Innovation at Every Level. This includes Connected Products, Edge Control, and Apps, Analytics & Services. EcoStruxure has been deployed in 450,000+ installations, with the support of 9,000 system integrators, connecting over 1 billion devices.

The launch of Schneider Electric ComPact NS in 1994 revolutionized the world of molded case circuit breakers and benefits from 60 years of experience and leadership in industrial circuit breakers.

As well as offering proven performance, flexibility and reliability, the ComPact NS sets the standard in most applications: buildings, windturbine, solar, genset, data center, healthcare, marine and infrastructure and decrease your energy consumption thanks to very low power dissipation.

Equipped with the Micrologic control units, ComPact NS630b to 3200 A circuit breakers offer built-in power and energy metering in addition to electrical measurement and analysis functions.

The communication option makes it possible to control power consumption, simplify maintenance and improve operating comfort.

A wide range of optimized auxiliaries and accessories is available to meet the needs of protection of AC installations, generator protection, motor protection, switch-disconnectors, source changeover switch function and specific offers available for DC applications up to 1000 V.

Today, the ComPact NS range remains the international reference in the molded-case, circuit breaker market.

schneider-electric.com/compactns

I design electrical solutions

More than 10 years of long-felt techniques and technologies ahead quite simple and convenient.



Win more projects and deliver the best solution for your customers

- Enhance power availability with total control of selectivity and power management with advanced trip unit.
- Optimize panel cost with cascading; the ComPact NS technology covers all your needs from 630 to 3200 A, with a breaking capacity from 50 to 200 kA.
- Equipped with electronic control units, the ComPact NS circuit breakers ensure protection and measurement of your electrical installation.
- Provide efficiency to your customer with small size and multi-ways of installation and highly immune protection system insensitive to disturbances (IEC 60947-2 Annex F).

Standards

ComPact NS circuit breakers and auxiliaries comply with:

- IEC/EN 60947-1: General rules
- IEC/EN 60947-2: Circuit-breakers
- IEC/EN 60947-3: Switch-disconnectors
- IEC/EN 60947-4-1: Contactors and motor-starters
- IEC/EN 60947-5-1: Control circuit devices

The ComPact NS range covers all ratings from 630 to 3200 A

ComPact NS630b to 1600

- ComPact NS from 630 to 1600 A, fixed or withdrawable, front or rear connection, manual operating mechanism or motor mechanism. A 200 kA breaking performance completes the ComPact NS range

ComPact NS1600b to 3200

- ComPact NS from 1600 to 3200 A, fixed, front connection, with manual operating mechanism

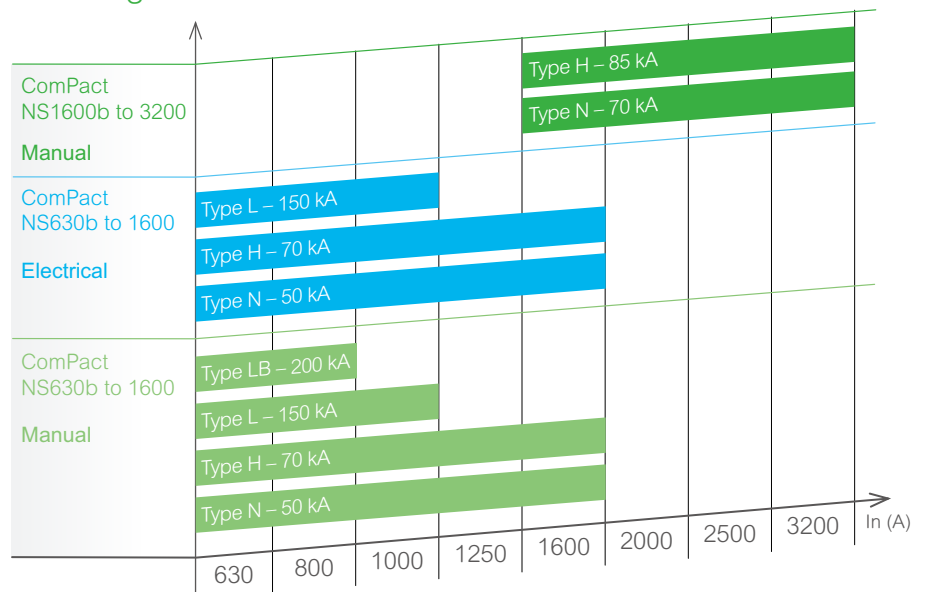

The MasterPact and ComPact range Circuit breakers, switch-disconnectors and source changeover are the best choice for all standards and specific applications.

> MasterPact MTZ



LVPED216026EN

> ComPact NSXm/NSX



LVPED217032EN

> ComPact INS/INV



LVPED213024EN

> Source-changeover systems



LVPED216028EN

> Complementary technical information



LVPED308005EN

I build and install electrical equipment

Make your business more profitable

Gain space in your switchboard

- The ComPact NS range is available in 2 sizes only in order to homogenize installation dimensions (volume, depth, pole pitch).
- Easy to select and to order with new Schneider Electric™ online tools.

Gain time, the installation is facilitated

- More space to connect your cables.
- Withdrawable version also available.



I design and build machines

Installation

Fixed device

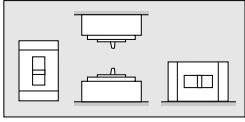

Withdrawable device

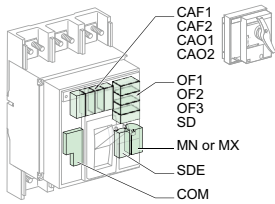

Manually operated device.

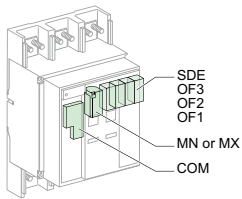

Electrically operated device.

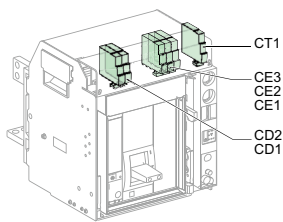

Withdrawable device.



Optimize your solution

- **Minimum distances** (safety clearance) between 2 circuit breakers are reduced thanks to the arc chute filters.
- **A solution for all your applications:**
 - generator protection
 - motor protection up to 750 kW with coordination between breakers and contactors (coordination type 1 and type 2)
 - source-changeover.
- **Best combination** of size (small depth), performance with no derating up to 65 °C (vertical connection) and flexible mounting options.
- **Ensure continuity of service:**
 - Total control of selectivity for the whole Schneider Electric circuit breakers range from moulded circuit breaker to air circuit breaker
 - High withstand of the devices to various environmental stresses.
- **Bring flexibility to your installation:**
Interchangeable trip units, standardized accessories, adjustable rating and scalable indication and control functions.



I operate my installation

I operate and manage my installation

Ensure continuity of service

- Electrical energy is available, prevent nuisance power outages using total control of selectivity.

Monitor your power

- Power consumption is optimized with on-site, real-time monitoring and control, plus online energy management services
- Maintenance is simplified
- Installation is scalable
- Using ComPact NS will decrease permanent consumption with lower power dissipations.



Architecture overview

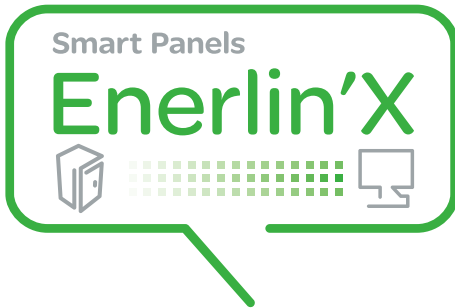

Ethernet-ready Smart Panels

Ethernet-ready Smart Panels enable electrical distribution control and expertise. 'Protect' - 'Measure' - 'Connect' are the 3 pillars of their technology.

PE119232.eps

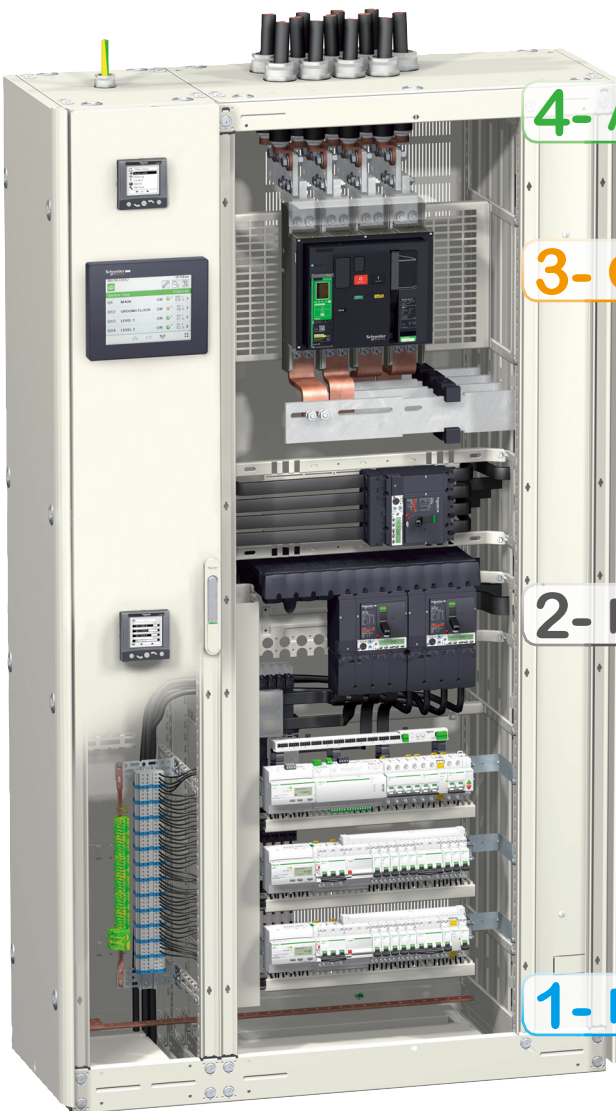

4- Act

3- Connect

Give a voice to the panel

Safe Ethernet network data transmission is now part of the intrinsic design of protection and metering devices

2- Measure

Keeping a close eye on energy flows

The switchboard plays a key role in capturing building-related data, by gathering the critical protection and metering components.

1- Protect

Electrical protection is at the core of Smart Panel

Reliable and high-performance technology is present in every breaker and every residual current device.

Architecture overview

Future savings, peace-of-mind

Access to Smart Panel status, values, is essential for taking advantages of monitoring and management services, locally or remotely.

Act in small/medium buildings

with FDM 128, Com'X 510, Power View, EcoStruxure™ Facility Expert



Electrical device monitoring and control with FDM 128, locally



Optimizing energy-efficiency

- Visualize, record energy consumption and WAGES.
- Comply with regulation .

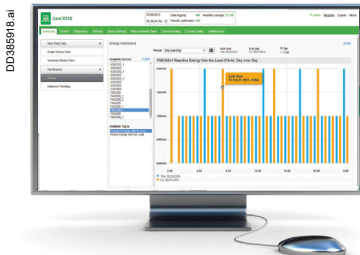

Com'X 510 web pages direct display, or Cloud based pages from other devices with Power View.



Improving continuity of service

- Get instant notifications
- Manage with assets-maintenance platform
- Get and analyze data for quick crisis-recovery

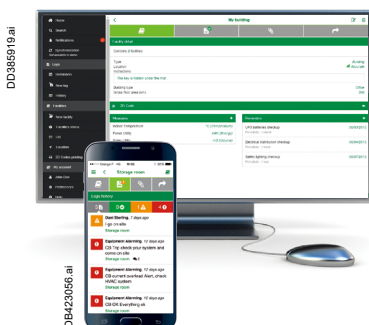

Distance management with EcoStruxure™ Facility Expert on Smartphone, tablet, PC



Increasing maintenance efficiency

- Operate preventive maintenance tools
- Follow maintenance & planning
- Provide business owner instant access to maintenance reports

Architecture overview

Day-to-day energy management

>> Power availability & quality, energy performance

For simply dealing with building user's needs and energy constraints.

EcoStruxure™ Building Management provides electrical management, monitoring and energy accounting.

Energy decisions are often crucial in large critical buildings, they must be informed.

EcoStruxure™ Power Monitoring Expert (software for PC) collects Smart Panels values to provide expert analysis.

Act in large non-critical buildings

with EcoStruxure™ Energy Expert



Managing equipment & key assets

- Check operating status, faults on custom on-line diagrams.



Monitoring electrical network

- Observe voltage disturbances, harmonics on graphics.
- Read power factor.



Accounting energy

- Record power meter data on dashboards.
- Allocate energy consumption with costs.
- Follow conservation goals.

Act in large critical buildings

with EcoStruxure™ Power Monitoring Expert^[1]



Analysing Power Events

- Speed up downtime crisis recovery
- Determine incident root cause, events sequence.
- Troubleshoot power quality issues.



Monitoring Power quality

- Be alerted of equipment affected by power quality issue.
- Compare power quality against industry standards.
- Collect facts for future discussion with Utility.



Analysing Energy Performance

- Evaluate building energy saving performance;
- Identify underperforming loads;
- Analyze Energy Conservation Measures (ECMs) according ISO50001 program.



[1] EcoStruxure™ Power Monitoring Expert, <http://pmedemo.biz/web/>
ID: demo & Password: demo

General contents

ComPact NS630b to 3200

Functions and characteristics

A

Installation recommendations

B

Dimensions and connection

C

Electrical diagrams

D

Additional characteristics

E

Catalogue numbers and order form

F

ComPact NS, even more applications...

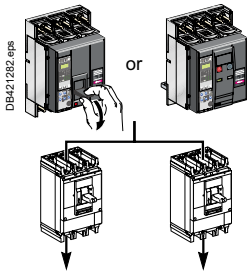

Protection of LV distribution systems

> pages **A-2** et **A-25**

- Protection for:
- distribution systems supplied by transformers
 - distribution systems supplied by engine generator sets
 - long cables in IT and TN systems.

Installation :

- in power switchboards.

All circuit breakers in the ComPact NS range offer positive contact indication and are suitable for isolation in compliance with standards IEC 60947-1 and 2.

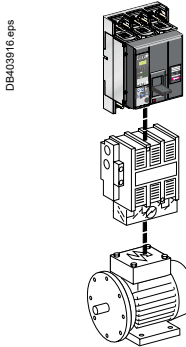

Protection of motors feeders (AC 220/690 V)

> page **A-44**

When combined with a motor starter, ComPact NS circuit breakers protect the cables and the starter against short-circuits. Equipped with an electronic trip unit, ComPact NS circuit breakers also protect the cables, starter and motor against overloads.

The exceptional current-limiting capacity of ComPact NS circuit breakers automatically ensures type-2 coordination with the motor starter, in compliance with standard IEC 60947-4-1.

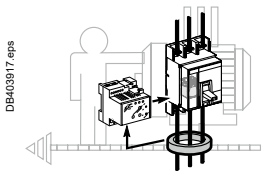

Earth-leakage

> page **A-45**

Additional earth-leakage protection protects life and property against the risks of faulty insulation in the installation.

Depending on the circuit breaker, earth-leakage protection is provided by:

- using a specific Micrologic control unit
- using a Vigirex relay and separate toroids.

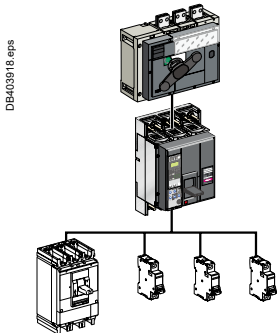

Service connection

ComPact NS service connection circuit breakers are specially designed for the service-connection function:

- lead seals and locking systems
- tripping curves certified by utilities
- fast overload curves to limit the power supplied, etc.

ComPact INV switch-disconnectors offering visible break (see the corresponding catalogue) can be combined with ComPact NS circuit breakers to constitute the various types of service connections and meet the needs of all installation configurations.

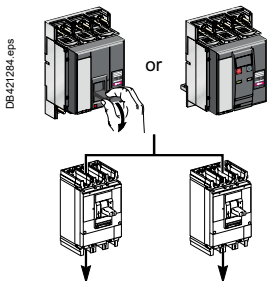

Control and isolation using switch-disconnectors

> page **A-46**

A switch-disconnector version of ComPact NS circuit breakers exists for circuit control and isolation. All the additional functions may be combined with the basic switch-disconnector function, including:

- earth-leakage protection
- motor mechanism.

For information on other switch-disconnector ranges, see the ComPact INS/INV (offering positive contact indication and visible break) and FuPact (fuse switch) catalogues.

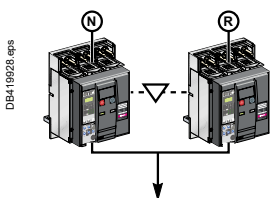

Source-changeover systems

> page **A-52**

To ensure a continuous supply of power, some electrical installations are connected to two power sources:

- a source "S1"
- a source "S2" to supply the installation when the source "S1" is not available.

A mechanical and/or electrical interlocking system between two circuit breakers or switch-disconnectors avoids all risk of parallel connection of the sources during switching.

A source-changeover system can be:

- manual with mechanical device interlocking
- remote controlled with mechanical and/or electrical device interlocking
- automatic by adding a controller to manage switching from one source to the other on the basis of external parameters.

(See Source-changeover catalogue for dimensions, connections and electrical drawings).

They can be combined with the FDM121 switchboard display unit to provide all the functions of a Power Meter as well as operating assistance.

Power Meter functions > page A-18



All ComPact circuit breakers are equipped with a Micrologic control unit that can be changed on site. Control units are designed to protect Power circuits and loads. Alarms may be programmed for remote indications. In addition to protection functions, Micrologic S/A/E/P control units offer all the functions of Power Meter products as well as operating-assistance for the circuit breaker.

Operating-assistance functions > page A-20



Integration of measurement functions provides operators with operating assistance functions including alarms tripped by user-selected measurement values, time-stamped event tables and histories, and maintenance indicators.

Switchboard-display unit functions > page A-21

The main measurements can be read on the built-in screen of Micrologic 2 / 5 / 6 / 7 trip units. They can also be displayed on the FDM switchboard display unit along with pop-up windows signalling the main alarms.

Communication > page A-28



ComPact NS equipped with Micrologic provide communication capabilities. Simple RJ45 cords connect to a Modbus interface module.

- IFM: Modbus interface module.
- IFE: Ethernet interface module.
- I/O application module.
- Ecoreach software.



Introduction

General characteristics for NS630b to 3200 range

DB421306.eps

Compact		
NS1600 H 		
Ui 800 V	Uimp 8 kV	
Ue (V)	Icu(kA)	Ics(kA)
220/240 a	70	37
380/415 a	70	37
440 a	65	37
500/525 a	50	30
660/690 a	42	22
Icw 19.2kA / 1s cat B		
50/60Hz IEC 60947-2		

Electrically operated ComPact NS circuit breaker.

DB421307.eps

Compact		
NS1600 H 		
Ui 800 V	Uimp 8 kV	
Ue (V)	Icu(kA)	Ics(kA)
220/240 a	85	37
380/415 a	70	37
440 a	65	37
500/525 a	50	30
660/690 a	42	22
Icw 19.2kA / 1s cat B		
50/60Hz IEC 60947-2		

Manually operated ComPact NS circuit breaker.

Standardised characteristics indicated on the rating plate:

- Ui: rated insulation voltage
- Uimp: rated impulse withstand voltage
- Icu: ultimate breaking capacity, for various values of the rated operational voltage Ue
- cat: utilisation category
- Icw: rated short-time withstand current
- Ics: service breaking capacity
- In: rated current
-  suitable for isolation

Compliance with standards

ComPact NS circuit breakers and auxiliaries comply with the following:

- international recommendations:
 - IEC 60947-1 - general rules
 - IEC 60947-2 - circuit breakers
 - IEC 60947-3 - switches, disconnectors, switch-disconnectors, etc.
 - IEC 60947-4 - contactors and motor starters
 - IEC 60947-5.1 and following - control circuit devices and switching elements; automatic control components
 - European (EN 60947-1 and EN 60947-2) and the corresponding national standards:
 - France NF
 - Germany VDE
 - U.K. BS
 - Australia AS
 - Italy CEI
 - the specifications of the marine classification companies (Veritas, Lloyd's Register of Shipping, Det Norske Veritas, etc.)
 - French standard NF C 79-130 and the recommendations issued by the CNOMO organisation for the protection of machine tools.
- For U.S. UL, Canadian CSA, Mexican NOM and Japanese JIS standards, please consult us.

Pollution degree

ComPact NS circuit breakers are certified for operation in pollution-degree 3 environments as defined by IEC standard 60947 (industrial environments).

Tropicalisation

ComPact NS circuit breakers have successfully passed the tests prescribed by the following standards for extreme atmospheric conditions:

- IEC 60068-2-1 - dry cold (-55 °C)
- IEC 60068-2-2 - dry heat (+85 °C)
- IEC 60068-2-30 - damp heat (95 % relative humidity at 55 °C)
- IEC 60068-2-52 - salt mist (severity level 2).

Environmental protection

ComPact NS circuit breakers take into account important concerns for environmental protection. Most components are recyclable and the parts of ComPact NS630b to NS3200 circuit breakers are marked as specified in applicable standards.

Ambient temperature

- ComPact NS circuit breakers may be used between -25 °C and +70 °C.
- For temperatures higher than 40 °C (65 °C for circuit breakers used to protect motor feeders), devices must be derated as indicated in the documentation.
- circuit-breakers should be put into service under normal ambient operating-temperature conditions. Exceptionally, the circuit breaker may be put into service when the ambient temperature is between -35 °C and -25 °C.
- the permissible storage-temperature range for ComPact NS circuit breakers in the original packing is -50 °C [1] to +85 °C.

Selectivity

As standard, the ComPact NS range ensures selectivity between two circuit breakers positioned in series in an installation.

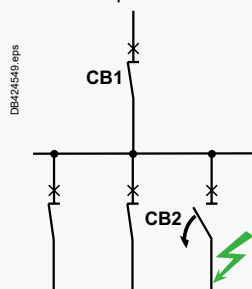

[1] -40 °C for Micrologic control units with an LCD screen.

General characteristics for NS630b to 3200 range

Positive contact indication

All ComPact NS circuit breakers are suitable for isolation as defined in IEC standard 60947-2:

- the isolation position corresponds to the O (OFF) position
- the operating handle cannot indicate the "OFF" position unless the contacts are effectively open
- padlocks may not be installed unless the contacts are open.

Installation of a rotary handle or a motor mechanism does not alter the reliability of the position-indication system.

The isolation function is certified by tests guaranteeing:

- the mechanical reliability of the position indication system
- the absence of leakage currents
- overvoltage withstand capacity between upstream and downstream connections.

Installation in class II switchboards

All ComPact NS circuit breakers are class II front face devices. They may be installed through the door of class II switchboards (as per IEC standard 60664), without downgrading switchboard insulation. Installation requires no special operations, even when the circuit breaker is equipped with a rotary handle or a motor mechanism.

Degree of protection

As per standards IEC 60529 (IP degree of protection) and EN 50102 (IK degree of protection against external mechanical impacts).

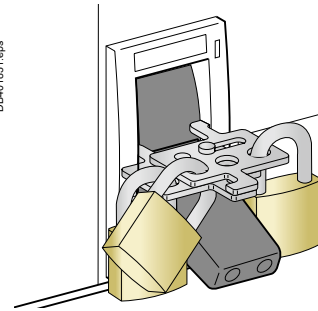

DBA401631.eps

Bare circuit breaker with terminal shields

	With toggle	IP40	IK07
	With direct rotary handle standard / VDE	IP40	IK07

Circuit breaker installed in a switchboard

	With toggle	IP40	IK07
	With direct rotary handle standard / VDE MCC CNOMO	IP40 IP435 IP547	IK07
	With extended rotary handle	IP55	IK08

Protection of distribution systems

Overview of solutions

Protection of distribution systems means protection of:

- systems supplied by a transformer
- systems supplied by an engine generator set
- long cables in IT and TN systems.

DE128023.eps

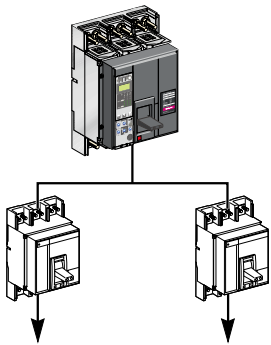

DB417642.eps

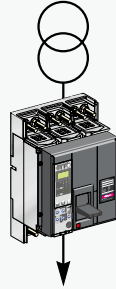

DB425841.eps

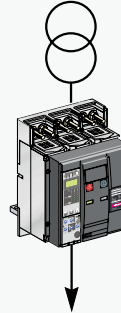

DB417643.eps

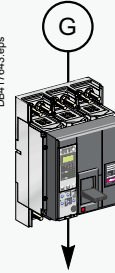

Power distribution

Selection of circuit breakers from 630 to 3200 A page A-2

Rated current (A)	630	800	1000	1250	1600
ComPact	NS630b	NS800	NS1000	NS1250	NS1600

PB104839_ME.eps



PB104831_ME.eps



Breaking capacity (kA rms) 380/415 V	N	50	50	50	50	50
	H	70	70	70	70	70
	L	150	150	150	-	-
	LB [1]	200	200	-	-	-

Rated current (A)	1600	2000	2500	3200
ComPact	NS1600b	NS2000	NS2500	NS3200

PB104843.eps



Breaking capacity (kA rms) 380/415 V	N	70	70	70
	H	85	85	85

Accompanying control units up to 3200 A page A-20

Micrologic electronic control units may be used on all ComPact NS630b to NS3200 circuit breakers and can be changed on site.

[1] Only for manual operated version.

Functions and characteristics

A

Protection of distribution systems	
ComPact NS circuit breakers from 630b up to 3200 A.....	A-2
Micrologic control units	
Overview of functions.....	A-6
For ComPact NS630b to 3200.....	A-8
Micrologic A "ammeter".....	A-10
Micrologic E "energy".....	A-12
Micrologic P "power".....	A-14
Power Meter functions	
Micrologic A/E/P control unit with COM option (BCM ULP) and COM Ethernet gateway.....	A-18
Operating-assistance functions	
Micrologic A/E/P control unit with COM option (BCM ULP).....	A-20
Switchboard-display functions	
Micrologic A/E/P control unit with COM option (BCM ULP).....	A-21
Micrologic A/E/P control unit with COM Ethernet gateway.....	A-23
Protection of distribution systems	
Micrologic control units for ComPact NS630b to 3200.....	A-25
Enerlin'X communication system	
Products overview.....	A-28
Communication	
Communication wiring system.....	A-30
Overview of functions.....	A-31
COM option in ComPact.....	A-32
Communication architecture.....	A-33
IFE Ethernet interface.....	A-34
IFM Modbus communication interface.....	A-36
Connection of the IFE to a fixed or drawout ComPact NS.....	A-38
Connection of the IFM to a fixed or drawout ComPact NS.....	A-39
I/O application module.....	A-40
Electrical Asset Manager Configuration Engineering tool.....	A-42
Motor protection	
Overview of solutions.....	A-44
Earth-leakage protection	
Overview of solutions.....	A-45
Control and isolation	
Overview of solutions.....	A-46
Control and disconnection	
ComPact NS630bNA to 1600NA switch-disconnectors.....	A-48
ComPact NS1600bNA to 3200NA switch-disconnectors.....	A-50
Source-changeover systems	
Presentation.....	A-52
Manual source-changeover systems.....	A-53
Electrical interlocking	
IVE unit.....	A-54
Remote-operated systems.....	A-55
Source-changeover systems	
Associated controllers.....	A-56
Electrical and mechanical accessories	
ComPact NS630b to 1600 (fixed version).....	A-58
ComPact NS630b to 1600 (withdrawable version).....	A-59
ComPact NS630b to 1600.....	A-60
ComPact NS1600b to 3200 (fixed version).....	A-77
ComPact NS1600b to 3200.....	A-78

Protection of distribution systems

ComPact NS circuit breakers from 630b up to 3200 A

A



PB104842_eps

ComPact NS800L.



PB104831_IME_eps

ComPact NS1600H.



PB104843_eps

ComPact NS2000H.

ComPact circuit breakers

Number of poles		
Control	manual	toggle
	direct or extended rotary handle	
	electric	

Type of circuit breaker

Connections	fixed	front connection
		rear connection
		front connection with bare cables
	withdrawable (on chassis)	front connection
		rear connection

Electrical characteristics as per IEC 60947-2 and EN 60947-2

Rated current (A)	I_n	50 °C
		65 °C [1]
Rated insulation voltage (V)	U_i	
Rated impulse withstand voltage (kV)	U_{imp}	
Rated operational voltage (V)	U_e	AC 50/60 Hz

Type of circuit breaker

Ultimate breaking capacity (kA rms)	Manual	I_{cu}	AC 50/60 Hz	220/240 V
				380/415 V
				440 V
				500/525 V
				660/690 V
		I_{cs}	AC 50/60 Hz	220/240 V
				380/415 V
				440 V
				500/525 V
				660/690 V
	Electrical	I_{cu}	AC 50/60 Hz	220/240 V
				380/415 V
				440 V
				500/525 V
				660/690 V
		I_{cs}	AC 50/60 Hz	220/240 V
				380/415 V
				440 V
				500/525 V
				660/690 V

Short-time withstand current (kA rms)	I_{cw}	AC	1 s
		50/60 Hz	3 s

Integrated instantaneous protection kA peak ± 10 %

Suitability for isolation

Utilisation category

Durability (C-O cycles)	mechanical	electrical	440 V	I _n /2
				I _n
			690 V	I _n /2
				I _n

Pollution degree

[1] 65 °C with vertical connections. See the temperature derating tables for other types of connections.

Protection of distribution systems

ComPact NS circuit breakers from 630b up to 3200 A

A

NS630b		NS800		NS1000			NS1250		NS1600		NS1600b		NS2000		NS2500		NS3200	
3, 4				3, 4			3, 4		3, 4		3, 4							
●				●			●		●		●							
●				●			●		●		●							
● (except LB)				●			●		●		●							
N	H	L	LB	N	H	L	N	H	N	H	N	H	N	H	N	H	N	H
●	●	●	-	●	●	●	●	●	●	●	●	●	●	●	●	●	●	●
●	●	●	●	●	●	●	●	●	●	●	●	●	-	-	-	-	-	-
●	●	-	-	●	●	-	●	●	-	-	-	-	-	-	-	-	-	-
●	●	●	●	●	●	●	●	●	●	●	●	●	-	-	-	-	-	-
●	●	●	●	●	●	●	●	●	●	●	●	●	-	-	-	-	-	-
630		800		1000			1250		1600		1600		2000		2500		3200	
630		800		1000			1250		1510		1550		1900		2500		2970	
1000				1000			1000		1000		1000							
8				8			8		8		8							
690				690			690		690		690							
N	H	L	LB	N	H	L	N	H	N	H	N	H	N	H	N	H	N	H
85	85	150	200	85	85	150	85	85	85	85	85	85	85	125	-	-	-	-
50	70	150	200	50	70	150	50	70	50	70	50	70	70	85	-	-	-	-
50	65	130	200	50	65	130	50	65	50	65	50	65	65	85	-	-	-	-
40	50	100	100	40	50	100	40	50	40	50	40	50	65	-	-	-	-	-
30	42	-	75	30	42	-	30	42	30	42	30	42	65	-	-	-	-	-
50	50	150	200	50	50	150	50	50	37	37	37	37	65	94	-	-	-	-
50	50	150	200	50	50	150	50	50	37	37	37	37	52	64	-	-	-	-
50	50	130	200	50	50	130	50	50	37	37	37	37	65	64	-	-	-	-
40	40	100	100	40	40	100	40	40	30	30	30	30	65	-	-	-	-	-
30	30	-	75	30	30	-	30	30	22	22	22	22	65	-	-	-	-	-
50	70	150	-	50	70	150	50	70	50	70	50	70	-	-	-	-	-	-
50	70	150	-	50	70	150	50	70	50	70	50	70	-	-	-	-	-	-
50	65	130	-	50	65	130	50	65	50	65	50	65	-	-	-	-	-	-
40	50	100	-	40	50	100	40	50	40	50	40	50	-	-	-	-	-	-
30	42	-	-	30	42	-	30	42	30	42	30	42	-	-	-	-	-	-
37	37	150	-	37	37	150	37	37	37	37	37	37	-	-	-	-	-	-
37	37	150	-	37	37	150	37	37	37	37	37	37	-	-	-	-	-	-
37	37	130	-	37	37	130	37	37	37	37	37	37	-	-	-	-	-	-
30	30	100	-	30	30	100	30	30	30	30	30	30	-	-	-	-	-	-
22	22	-	-	22	22	-	22	22	22	22	22	22	-	-	-	-	-	-
19.2	19.2	-	-	19.2	19.2	-	19.2	19.2	19.2	19.2	19.2	19.2	-	-	-	-	-	-
-	-	-	-	-	-	-	-	-	-	-	-	-	32	-	-	-	-	-
40	40	-	-	40	40	-	40	40	40	40	40	40	130	-	-	-	-	-
●				●			●		●		●		●					
B	B	A	A	B	B	A	B	B	B	B	B	B	B					
10000				10000			10000		10000		10000		5000					
6000	6000	4000	4000	6000	6000	4000	5000		5000		5000		3000					
5000	5000	3000	3000	5000	5000	3000	4000		2000		2000		2000					
4000	4000	3000	3000	4000	4000	3000	3000		2000		2000		2000					
2000	2000	2000	2000	2000	2000	2000	2000		1000		1000		1000					
3				3			3		3		3		3					

Protection of distribution systems

ComPact NS circuit breakers from 630b up to 3200 A

A



Electrically operated device.

ComPact circuit breakers

Protection and measurements

Interchangeable control units

Overload protection long time **I_r** (I_n x ...)

Short-circuit protection short time **I_{sd}** (I_r x ...)
instantaneous **I_i** (I_n x ...)

Earth-fault protection **I_g** (I_n x ...)

Residual earth-leakage protection **I_{Δn}**

Zone selective interlocking **ZSI**

Protection of the fourth pole

Current measurements

Power measurements

Advanced protection

Quick view

Remote communication by bus

Device-status indication

Device remote operation ^[2]

Transmission of settings

Indication and identification of protection devices and alarms

Transmission of measured current values

ComPact circuit breakers

Additional indication and control auxiliaries

Indication contacts

Voltage releases MX shunt release/MN undervoltage release

Installation

Accessories terminal extensions and spreaders
terminal shields and interphase barriers
escutcheons

Dimensions fixed devices, front connections (mm) 3P

H x W x D 4P

Weight fixed devices, front connections (kg) 3P

4P

Source changeover system (see section on "source changeover systems")

Manual, remote-operated and automatic source changeover systems

[1] Except 1600b-3200.

[2] With NS630b...NS1600, remote operation is possible with electrically operated device.
With NS1600...NS3200, remote operation is not possible.

Protection of distribution systems

ComPact NS circuit breakers from 630b up to 3200 A

A

NS630b		NS800		NS1000		NS1250		NS1600		NS1600b		NS2000		NS2500		NS3200	
Micrologic																	
2.0	5.0	6.0	2.0A	5.0A	6.0A	7.0A	2.0E	5.0E	6.0E	5.0P ^[1]	6.0P ^[1]	7.0P ^[1]					
⊙	⊙	⊙	⊙	⊙	⊙	⊙	⊙	⊙	⊙	⊙	⊙	⊙					
-	⊙	⊙	-	⊙	⊙	⊙	-	⊙	⊙	⊙	⊙	⊙					
⊙	⊙	⊙	⊙	⊙	⊙	⊙	⊙	⊙	⊙	⊙	⊙	⊙					
-	-	⊙	-	-	⊙	-	-	-	⊙	-	⊙	-					
-	-	-	-	-	-	⊙	-	-	-	-	-	⊙					
-	-	-	⊙	⊙	⊙	⊙	⊙	⊙	⊙	⊙	⊙	⊙					
⊙	⊙	⊙	⊙	⊙	⊙	⊙	⊙	⊙	⊙	⊙	⊙	⊙					
-	-	-	⊙	⊙	⊙	⊙	⊙	⊙	⊙	⊙	⊙	⊙					
-	-	-	-	-	-	-	⊙	⊙	⊙	⊙	⊙	⊙					
-	-	-	-	-	-	-	-	-	-	⊙	⊙	⊙					
-	-	-	-	-	-	-	⊙	⊙	⊙	-	-	-					
⊙	⊙	⊙	⊙	⊙	⊙	⊙	⊙	⊙	⊙	⊙	⊙	⊙					
⊙	⊙	⊙	⊙	⊙	⊙	⊙	⊙	⊙	⊙	⊙	⊙	⊙					
-	-	-	⊙	⊙	⊙	⊙	⊙	⊙	⊙	⊙	⊙	⊙					
-	-	-	⊙	⊙	⊙	⊙	⊙	⊙	⊙	⊙	⊙	⊙					
-	-	-	⊙	⊙	⊙	⊙	⊙	⊙	⊙	⊙	⊙	⊙					
NS630b		NS800		NS1000		NS1250		NS1600		NS1600b		NS2000		NS2500		NS3200	
⊙								⊙									
⊙								⊙									
⊙								-									
⊙								⊙									
⊙								⊙									
327 x 210 x 147								350 x 420 x 160									
327 x 280 x 147								350 x 535 x 160									
14								24									
18								36									
⊙								-									

Micrologic control units

Overview of functions

A

All ComPact circuit breakers are equipped with a Micrologic control unit that can be changed on site. Control units are designed to protect Power circuits and loads. Alarms may be programmed for remote indications. Measurements of current, voltage, frequency, power and power quality optimise continuity of service and energy management.

Dependability

Integration of protection functions in an ASIC electronic component used in all Micrologic control units guarantees a high degree of reliability and immunity to conducted or radiated disturbances. On Micrologic A, E and P control units, advanced functions are managed by an independent microprocessor.

Accessories

Certain functions require the addition of Micrologic control unit accessories, described on [page A-28](#). The rules governing the various possible combinations can be found in the documentation accessible via the Products and services menu of the www.schneider-electric.com web site.

Micrologic name codes



- X: type of protection
- 2 for basic protection
 - 5 for selective protection
 - 6 for selective + earth-fault protection
 - 7 for selective + earth-leakage protection.
- Y: control-unit generation
Identification of the control-unit generation. "0" signifies the first generation.
- Z: type of measurement
- A for "ammeter"
 - E for "energy"
 - P for "power meter"



Current protection

Micrologic 2: basic protection

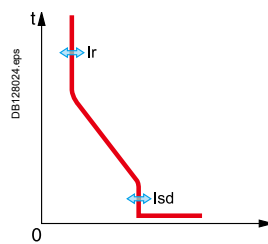

Protection:
long time
+ instantaneous

Micrologic 5: selective protection

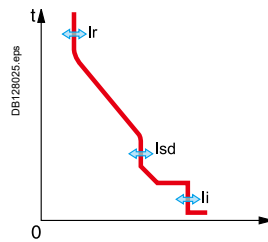

Protection:
long time
+ short time
+ instantaneous

Micrologic 6: selective + earth-fault protection

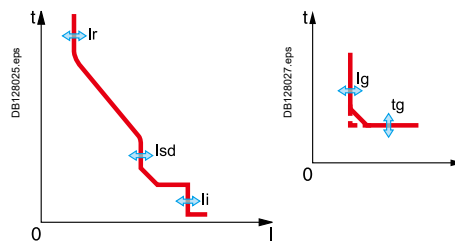

Protection:
long time
+ short time
+ instantaneous
+ earth fault

Micrologic 7: selective + earth-leakage

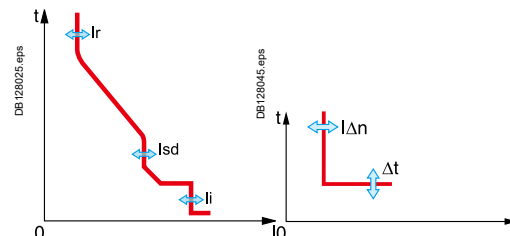

Protection:
long time
+ short time
+ instantaneous
+ earth leakage up to 3200A

Micrologic without measurement **Measurements and programmable protection**

A

A: ammeter

- I_1, I_2, I_3, I_N , earth-fault, earth-leakage and maximeter for these measurements
- fault indications
- settings in amperes and in seconds.

E: Energy

- incorporates all the rms measurements of Micrologic A, plus voltage, power factor, power and energy metering measurements.
- calculates the current demand value
- "Quickview" function for the automatic cyclical display of the most useful values (as standard or by selection).

P: A + power meter + programmable protection

- measurements of V, A, W, VAR, VA, Wh, VARh, VAh, Hz, V_{peak} , A_{peak} , power factor and maximeters and minimeters
- IDMTL long-time protection, minimum and maximum voltage and frequency, voltage and current imbalance, phase sequence, reverse power
- load shedding and reconnection depending on power or current
- measurements of interrupted currents, differentiated fault indications, maintenance indications, event histories and time-stamping, etc.

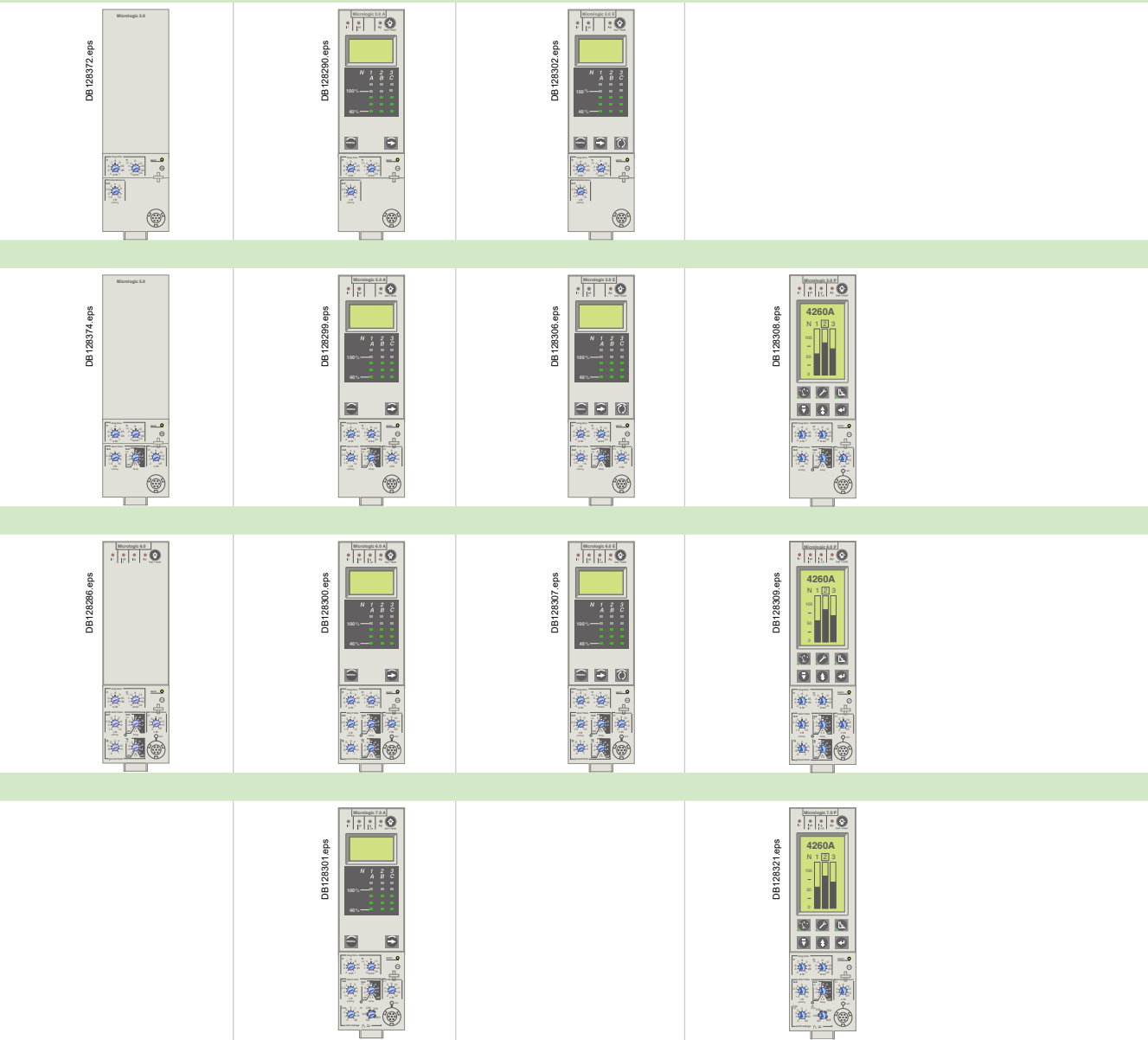

Micrologic control units

For ComPact NS630b to 3200

A

Micrologic 2.0, 5.0 and 6.0 control units protect power circuits. Micrologic 5.0 and 6.0 offers time selectivity for short-circuits as well.

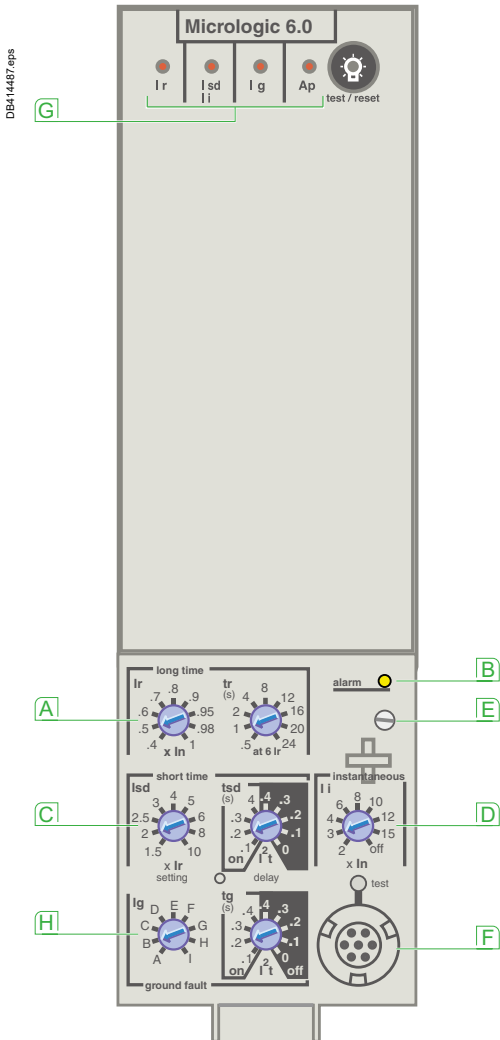

- A** long-time threshold and tripping delay
- B** overload alarm (LED)
- C** short-time pick-up and tripping delay
- D** instantaneous pick-up
- E** fixing screw for long-time rating plug
- F** test connector
- G** indication of tripping cause
- H** earth-leakage or earth-fault pick-up and tripping delay

Note: Micrologic control units are equipped with a transparent lead-seal cover as standard.

Protection

Protection thresholds and delays are set using the adjustment dials.

Overload protection

True rms long-time protection.

Thermal memory: thermal image before and after tripping.

Setting accuracy may be enhanced by limiting the setting range using a different long-time rating plug.

Overload protection can be cancelled using a specific LT rating plug "Off".

Short-circuit protection

Short-time (rms) and instantaneous protection.

Selection of I²t type (ON or OFF) for short-time delay.

Earth-fault protection

Residual or source ground return earth fault protection.

Selection of I²t type (ON or OFF) for delay.

Neutral protection

On three-pole circuit breakers, neutral protection is not possible.

On four-pole circuit breakers, neutral protection may be set using a three-position switch: neutral unprotected (4P 3d), neutral protection at 0.5 Ir (4P 3d + N/2) or neutral protection at Ir (4P 4d).

Indications

Overload indication by alarm LED on the front; the LED goes on when the current exceeds the long-time trip threshold.

Test

A mini test kit or a portable test kit may be connected to the test connector on the front to check circuit-breaker operation after installing the trip unit or accessories.

Fault indications (only for micrologic 6.0)

LEDs indicate the type of fault:

- overload (long-time protection Ir)
- short-circuit (short-time Isd or instantaneous Ii protection)
- earth fault or earth leakage (Ig)
- internal fault (Ap).

Battery power

The fault indication LEDs remain on until the test/reset button is pressed. Under normal operating conditions, the battery supplying the LEDs has a service life of approximately 10 years.

Functions and characteristics

Micrologic control units

For ComPact NS630b to 3200



Micrologic 2.0

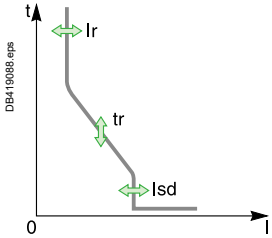

Long-time													
Current setting (A)	$I_r = I_n \times \dots$	0.4	0.5	0.6	0.7	0.8	0.9	0.95	0.98	1			
tripping between 1.05 and 1.20 x Ir		other ranges or disable by changing long-time rating plug											
Time setting	t_r (s)	$t_r = 0.5 \text{ s to } 24 \text{ s, step } 0.5 \text{ s for } 6 I_r$											
Time setting example:	Accuracy: 0 to -30 %	1.5 x Ir	12.5	25	50	100	200	300	400	500	600		
time delay (s)	Accuracy: 0 to -20 %	6 x Ir	0.5 [1]	1	2	4	8	12	16	20	24		
	Accuracy: 0 to -20 %	7.2 x Ir	0.7 [2]	0.69	1.38	2.7	5.5	8.3	11	13.8	16.6		
Thermal memory		20 minutes before and after tripping											
Instantaneous													
Pick-up (A)	$I_{sd} = I_r \times \dots$	1.5	2	2.5	3	4	5	6	8	10			
Accuracy: ±10 %													
Time delay		Max resettable time: 20 ms Max break time: 80 ms											

Micrologic 5.0 / 6.0 / 7.0

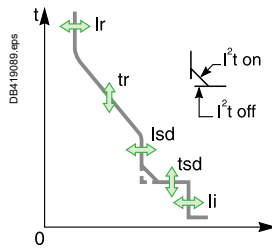

Long-time													
Current setting (A)	$I_r = I_n \times \dots$	0.4	0.5	0.6	0.7	0.8	0.9	0.95	0.98	1			
tripping between 1.05 and 1.20 x Ir		Other ranges or disable by changing long-time rating plug											
Time setting	t_r (s)	0.5	1	2	4	8	12	16	20	24			
Time setting example:	Accuracy: 0 to -30 %	1.5 x Ir	12.5	25	50	100	200	300	400	500	600		
time delay (s)	Accuracy: 0 to -20 %	6 x Ir	0.5 [1]	1	2	4	8	12	16	20	24		
	Accuracy: 0 to -20 %	7.2 x Ir	0.7 [2]	0.69	1.38	2.7	5.5	8.3	11	13.8	16.6		
Thermal memory		20 minutes before and after tripping											
Short-time													
Pick-up (A)	$I_{sd} = I_r \times \dots$	1.5	2	2.5	3	4	5	6	8	10			
Accuracy: ±10 %													
Time setting tsd (s)	Settings	I^2t Off	0	0.1	0.2	0.3	0.4						
		I^2t On	-	0.1	0.2	0.3	0.4						
Operating time at 10 x Ir max resettable time		20	80	140	230	350							
I^2t Off or I^2t On max break time		80	140	200	320	500							
Instantaneous													
Pick-up (A)	$I_i = I_n \times \dots$	2	3	4	6	8	10	12	15	off			
Accuracy: ±10 %													
Operating time		Standard											
max resettable time		20 ms											
max break time		50 ms											

Micrologic 6.0

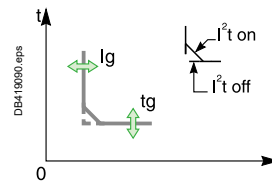

Earth fault												
Pick-up (A)	$I_g = I_n \times \dots$	A	B	C	D	E	F	G	H	J		
Accuracy: ±10 %	$I_n \leq 400 \text{ A}$	0.3	0.3	0.4	0.5	0.6	0.7	0.8	0.9	1		
	$400 \text{ A} < I_n < 1250 \text{ A}$	0.2	0.3	0.4	0.5	0.6	0.7	0.8	0.9	1		
	$I_n \geq 1250 \text{ A}$	500	640	720	800	880	960	1040	1120	1200		
Time setting t_g (s)	Settings	I^2t Off	0	0.1	0.2	0.3	0.4					
		I^2t On	-	0.1	0.2	0.3	0.4					
Time delay (ms) at I_n or 1200 A (I^2t Off or I^2t On)	$t_g = \text{max resettable time}$	20	80	140	230	350						
	$t_g = \text{max break time}$	80	140	200	320	500						

Note: all current-based protection functions require no auxiliary source.
The test / reset button resets maximeters, clears the tripping indication and tests the battery.

[1] 0 to -40 % - [2] 0 to -60 %

Micrologic control units

Micrologic A "ammeter"

A

Micrologic A control units protect power circuits. They also offer measurements, display, communication and current maximeters. Version 6 provides earth-fault protection, version 7 provides earth-leakage protection.

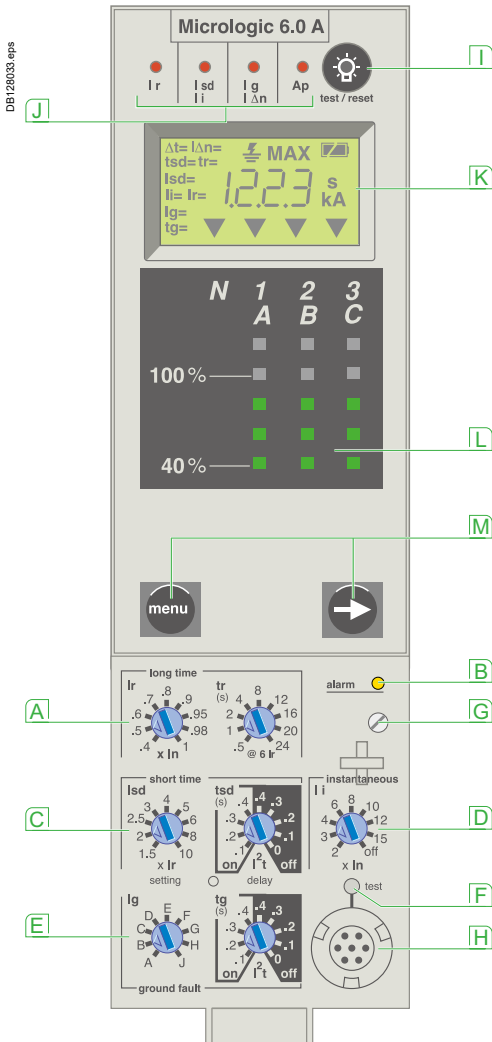

- A** long-time threshold and tripping delay
- B** overload alarm (LED) at 1.125 I_r
- C** short-time pick-up and tripping delay
- D** instantaneous pick-up
- E** earth-leakage or earth-fault pick-up and tripping delay
- F** earth-leakage or earth-fault test button
- G** long-time rating plug screw
- H** test connector
- I** lamp test, reset and battery test
- J** indication of tripping cause
- K** digital display
- L** three-phase bargraph and ammeter
- M** navigation buttons

Note: Micrologic A control units come with a transparent lead-seal cover as standard.

"Ammeter" measurements

Micrologic A control units measure the true (rms) value of currents. They provide continuous current measurements from 0.2 to 1.2 I_n and are accurate to within 1.5 % (including the sensors).

A digital LCD screen continuously displays the most heavily loaded phase (I_{max}) or displays the I₁, I₂, I₃, I_n, I_g, I_{Δn}, stored-current (maximeter) and setting values by successively pressing the navigation button.

The optional external power supply makes it possible to display currents < 20 % I_n. Below 0.1 I_n, measurements are not significant. Between 0.1 and 0.2 I_n, accuracy changes linearly from 4 % to 1.5 %.

Communication option (COM)

In conjunction with the communication option, the control unit transmits the following:

- settings
- all "ammeter" measurements
- tripping causes
- maximeter readings.

Protection

Protection thresholds and delays are set using the adjustment dials.

Overload protection

True rms long-time protection.

Thermal memory: thermal image before and after tripping.

Setting accuracy may be enhanced by limiting the setting range using a different long-time rating plug.

Overload protection can be cancelled using a specific LT rating plug "Off".

Short-circuit protection

Short-time (rms) and instantaneous protection.

Selection of I²t type (ON or OFF) for short-time delay.

Earth-fault protection

Residual or source ground return earth fault protection.

Selection of I²t type (ON or OFF) for delay.

Residual earth-leakage protection (Vigi).

Operation without an external power supply. Δ Protected against nuisance tripping.

$\tilde{\Delta}$ DC-component withstand class A up to 10 A.

Neutral protection

On three-pole circuit breakers, neutral protection is not possible. On four-pole circuit breakers, neutral protection may be set using a three-position switch: neutral unprotected (4P 3d), neutral protection at 0.5 I_r (4P 3d + N/2), neutral protection at I_r (4P 4d).

Zone selective interlocking (ZSI)

A ZSI terminal block may be used to interconnect a number of control units to provide total selectivity for short-time and earth-fault protection, without a delay before tripping.

Overload alarm

A yellow alarm LED goes on when the current exceeds the long-time trip threshold.

Fault indications

LEDs indicate the type of fault:

- overload (long-time protection I_r)
- short-circuit (short-time I_{sd} or instantaneous I_i protection)
- earth fault or earth leakage (I_g or I_{Δn})
- internal fault (A_p).

Battery power

The fault indication LEDs remain on until the test/reset button is pressed. Under normal operating conditions, the battery supplying the LEDs has a service life of approximately 10 years.

Test

A mini test kit or a portable test kit may be connected to the test connector on the front to check circuit-breaker operation. For Micrologic 6.0 A and 7.0 A control units, the operation of earth-fault or earth-leakage protection can be checked by pressing the test button located above the test connector.

Functions and characteristics

Micrologic control units

Micrologic A "ammeter"



Micrologic 2.0 A

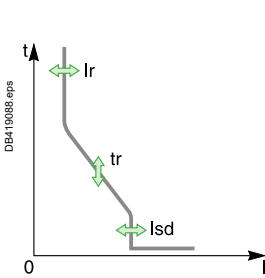

Long-time		ANSI Code 49											
Current setting (A)	$I_r = I_n \times \dots$	0.4	0.5	0.6	0.7	0.8	0.9	0.95	0.98	1	Other ranges or disable by changing long-time rating plug		
Time setting example: time delay (s)	tr (s)	0.5	1	2	4	8	12	16	20	24			
	Accuracy: 0 to -30 %	1.5 x Ir	12.5	25	50	100	200	300	400	500	600		
	Accuracy: 0 to -20 %	6 x Ir	0.7 ^[1]	1	2	4	8	12	16	20	24		
	Accuracy: 0 to -20 %	7.2 x Ir	0.7 ^[2]	0.69	1.38	2.7	5.5	8.3	11	13.8	16.6		
Thermal memory		20 minutes before and after tripping											
Instantaneous		ANSI Code 50											
Pick-up (A)	$I_{sd} = I_r \times \dots$	1.5	2	2.5	3	4	5	6	8	10			
Accuracy: ±10 %													
Time delay		Max resettable time: 20 ms Max break time: 80 ms											

Micrologic 5.0 / 6.0 / 7.0 A

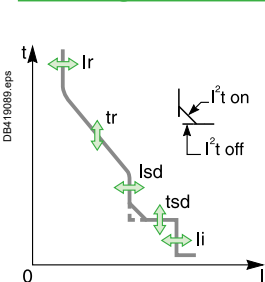

Long-time		ANSI Code 49											
Current setting (A)	$I_r = I_n \times \dots$	0.4	0.5	0.6	0.7	0.8	0.9	0.95	0.98	1	Other ranges or disable by changing long-time rating plug		
Tripping between 1.05 and 1.20 x Ir													
Time setting example: time delay (s)	tr (s)	0.5	1	2	4	8	12	16	20	24			
	Accuracy: 0 to -30 %	1.5 x Ir	12.5	25	50	100	200	300	400	500	600		
	Accuracy: 0 to -20 %	6 x Ir	0.7 ^[1]	1	2	4	8	12	16	20	24		
	Accuracy: 0 to -20 %	7.2 x Ir	0.7 ^[2]	0.69	1.38	2.7	5.5	8.3	11	13.8	16.6		
Thermal memory		20 minutes before and after tripping											
Short-time		ANSI Code 51											
Pick-up (A)	$I_{sd} = I_r \times \dots$	1.5	2	2.5	3	4	5	6	8	10			
Accuracy: ±10 %													
Time setting tsd (s)	Settings	I²t Off	0	0.1	0.2	0.3	0.4						
		I²t On	-	0.1	0.2	0.3	0.4						
Operating time at 10 x Ir	tsd (max resettable time)	20	80	140	230	350							
I²t Off or I²t On	tsd (max break time)	80	140	200	320	500							
Instantaneous		ANSI Code 50											
Pick-up (A)	$I_i = I_n \times \dots$	2	3	4	6	8	10	12	15	off			
Accuracy: ±10 %													
Operating time	max resettable time	20 ms											
	max break time	50 ms											

Micrologic 6.0 A

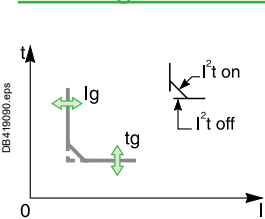

Earth fault		ANSI Code 51N										
Pick-up (A)	$I_g = I_n \times \dots$	A	B	C	D	E	F	G	H	J		
Accuracy: ±10 %												
	$I_n \leq 400 \text{ A}$	0.3	0.3	0.4	0.5	0.6	0.7	0.8	0.9	1		
	$400 \text{ A} < I_n < 1250 \text{ A}$	0.2	0.3	0.4	0.5	0.6	0.7	0.8	0.9	1		
	$I_n \geq 1250 \text{ A}$	500	640	720	800	880	960	1040	1120	1200		
Time setting tg (s)	Settings	I²t Off	0	0.1	0.2	0.3	0.4					
		I²t On	-	0.1	0.2	0.3	0.4					
Time delay (ms) at In or 1200 A	tg = max resettable time	20	80	140	230	350						
(I²t Off or I²t On)	tg = max break time	80	140	200	320	500						

Micrologic 7.0 A

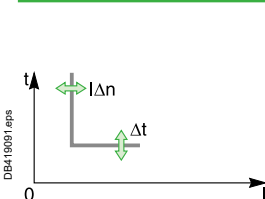

Residual earth leakage (Vigi) ANSI Code 51G												
Sensitivity (A)	$I_{\Delta n}$	0.5	1	2	3	5	7	10	20	30		
Accuracy: 0 to -20 %												
Time delay Δt (ms)	Settings	60	140	230	350	800						
	max resettable time	60	140	230	350	800						
	max break time	140	200	320	500	1000						

Micrologic 5.0 / 6.0 / 7.0 A

Ammeter		
Instantaneous currents	I_1, I_2, I_3, I_N	0.2 x In to 1.2 x In ±1.5 %
	$I_g (6.0 \text{ A})$	0.2 x In to In ±10 %
	$I_{\Delta n} (7.0 \text{ A})$	0 to 30 A ±1.5 %
Current maximeters of	I_1, I_2, I_3, I_N	0.2 x In to 1.2 x In ±1.5 %

Note: all current-based protection functions require no auxiliary source.
The test / reset button resets maximeters, clears the tripping indication and tests the battery.
[1] 0 to -40 % - [2] 0 to -60 %

Micrologic control units

Micrologic E “energy”

Micrologic E control units protect power circuits. They also offer measurements, display, communication and current maximeters. Version 6 provides earth-fault protection.

A

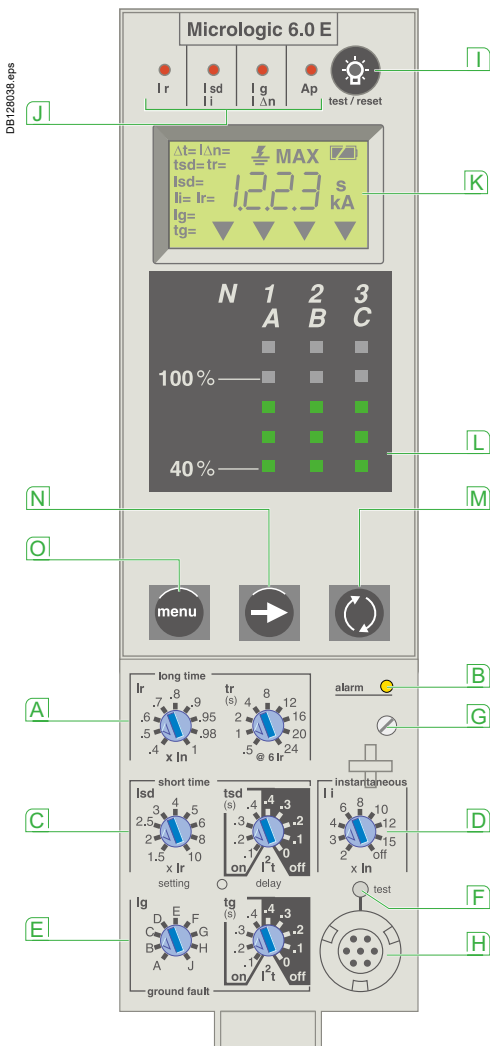

- A** long-time threshold and tripping delay
- B** overload alarm (LED) at 1.125 Ir
- C** short-time pick-up and tripping delay
- D** instantaneous pick-up
- E** earth-leakage or earth-fault pick-up and tripping delay
- F** earth-leakage or earth-fault test button
- G** long-time rating plug screw
- H** test connector
- I** lamp test, reset and battery test
- J** indication of tripping cause
- K** digital display
- L** three-phase bargraph and ammeter
- M** navigation button "quick View" (only with Micrologic E)
- N** navigation button to view menu contents
- O** navigation button to change menu

[1] Display on FDM121 only.

Note: Micrologic E control units come with a transparent lead-seal cover as standard.

"Energy meter" measurements

In addition to the ammeter measurements of Micrologic A Micrologic E control units measure and display:

- current demand
- voltages: phase to phase, phase to neutral, average [1] and unbalanced [1]
- instantaneous power: P, Q, S
- power factor: PF
- power demand: P demand
- energy: Ep, Eq [1], Es [1].

Accuracy of active energy Ep is 2 % (including the sensors). The range of measurement is the same as current with Micrologic A, depending on an external power supply module (24 V DC).

Communication option (COM)

In conjunction with the communication option, the control unit transmits the following:

- settings
- all "ammeter" and "energy" measurements
- enable connection to FDM128
- tripping causes
- maximeter / minimeter readings.

Protection

Protection thresholds and delays are set using the adjustment dials.

Overload protection

True rms long-time protection.

Thermal memory: thermal image before and after tripping.

Setting accuracy may be enhanced by limiting the setting range using a different long-time rating plug. Overload protection can be cancelled using a specific LT rating plug "Off".

Short-circuit protection

Short-time (rms) and instantaneous protection.

Selection of I²t type (ON or OFF) for short-time delay.

Earth-fault protection

Residual or source ground return earth fault protection.

Selection of I²t type (ON or OFF) for delay.

Neutral protection

On three-pole circuit breakers, neutral protection is not possible.

On four-pole circuit breakers, neutral protection may be set using a three-position switch: neutral unprotected (4P 3d), neutral protection at 0.5 Ir (4P 3d + N/2), neutral protection at Ir (4P 4d).

Zone selective interlocking (ZSI)

A ZSI terminal block may be used to interconnect a number of control units to provide total selectivity for short-time and earth-fault protection, without a delay before tripping.

Overload alarm

A yellow alarm LED goes on when the current exceeds the long-time trip threshold.

Fault indications

LEDs indicate the type of fault:

- overload (long-time protection Ir)
- short-circuit (short-time lsd or instantaneous li protection)
- earth fault (I_g)
- internal fault (Ap).

Trip history

The trip history displays the list of the last 10 trips. For each trip, the following indications are recorded and displayed:

- the tripping cause: Ir, lsd, li, Ig or Auto-protection (Ap) trips
- the date and time of the trip (requires communication option).

Battery power

The fault indication LEDs remain on until the test/reset button is pressed. Under normal operating conditions, the battery supplying the LEDs has a service life of approximately 10 years.

Test

A mini test kit or a portable test kit may be connected to the test connector on the front to check circuit-breaker operation. For Micrologic 6.0 E control units, the operation of earth-fault or earth-leakage protection can be checked by pressing the test button located above the test connector.

Functions and characteristics

Micrologic control units

Micrologic E “energy”



Micrologic 2.0 E

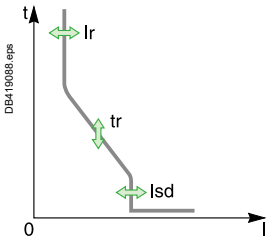

Long-time		ANSI Code 49											
Current setting (A)	$I_r = I_n \times \dots$	0.4	0.5	0.6	0.7	0.8	0.9	0.95	0.98	1	Other ranges or disable by changing long-time rating plug		
Time setting example: time delay (s)	tr (s)	0.5	1	2	4	8	12	16	20	24			
	Accuracy: 0 to -30 %	1.5 x Ir	12.5	25	50	100	200	300	400	500	600		
	Accuracy: 0 to -20 %	6 x Ir	0.7 ^[1]	1	2	4	8	12	16	20	24		
	Accuracy: 0 to -20 %	7.2 x Ir	0.7 ^[2]	0.69	1.38	2.7	5.5	8.3	11	13.8	16.6		
Thermal memory	20 minutes before and after tripping												
Instantaneous		ANSI Code 50											
Pick-up (A)	$I_{sd} = I_r \times \dots$	1.5	2	2.5	3	4	5	6	8	10			
Accuracy: ±10 %													
Time delay	Max resettable time: 20 ms Max break time: 80 ms												

Micrologic 5.0 / 6.0 E

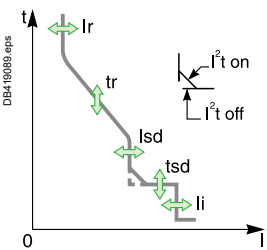

Long-time		ANSI Code 49											
Current setting (A)	$I_r = I_n \times \dots$	0.4	0.5	0.6	0.7	0.8	0.9	0.95	0.98	1	Other ranges or disable by changing long-time rating plug		
Tripping between 1.05 and 1.20 x Ir													
Time setting example: time delay (s)	tr (s)	0.5	1	2	4	8	12	16	20	24			
	Accuracy: 0 to -30 %	1.5 x Ir	12.5	25	50	100	200	300	400	500	600		
	Accuracy: 0 to -20 %	6 x Ir	0.7 ^[1]	1	2	4	8	12	16	20	24		
	Accuracy: 0 to -20 %	7.2 x Ir	0.7 ^[2]	0.69	1.38	2.7	5.5	8.3	11	13.8	16.6		
Thermal memory	20 minutes before and after tripping												
Short-time		ANSI Code 51											
Pick-up (A)	$I_{sd} = I_r \times \dots$	1.5	2	2.5	3	4	5	6	8	10			
Accuracy: ±10 %													
Time setting tsd (s)	Settings	I ² t Off	0	0.1	0.2	0.3	0.4						
		I ² t On	-	0.1	0.2	0.3	0.4						
Operating time at 10 x Ir	tsd (max resettable time)	20	80	140	230	350							
I ² t Off or I ² t On	tsd (max break time)	80	140	200	320	500							
Instantaneous		ANSI Code 50											
Pick-up (A)	$I_i = I_n \times \dots$	2	3	4	6	8	10	12	15	off			
Accuracy: ±10 %													
Operating time	max resettable time	20 ms											
	max break time	50 ms											

Micrologic 6.0 E

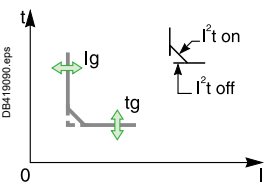

Earth fault		ANSI Code 51N										
Pick-up (A)	$I_g = I_n \times \dots$	A	B	C	D	E	F	G	H	J		
Accuracy: ±10 %	$I_n \leq 400 \text{ A}$	0.3	0.3	0.4	0.5	0.6	0.7	0.8	0.9	1		
	$400 \text{ A} < I_n < 1250 \text{ A}$	0.2	0.3	0.4	0.5	0.6	0.7	0.8	0.9	1		
	$I_n \geq 1250 \text{ A}$	500	640	720	800	880	960	1040	1120	1200		
Time setting tg (s)	Settings	I ² t Off	0	0.1	0.2	0.3	0.4					
		I ² t On	-	0.1	0.2	0.3	0.4					
Time delay (ms) at In or 1200 A (I ² t Off or I ² t On)	tg = max resettable time	20	80	140	230	350						
	tg = max break time	80	140	200	320	500						

Micrologic 5.0 / 6.0 / 7.0 E

Energy			
Instantaneous currents	I1, I2, I3, In	0.2 x In to 1.2 x In	±1.5 %
	Ig (6.0 E)	0.2 x In to In	±10 %
Current maximeters of Demand currents of I1, I2, I3, Ig	I1, I2, I3, In	0.2 x In to 1.2 x In	±1.5 %
Voltages	V12, V23, V31, V1N, V2N, V3N	100 to 690 V	±0.5 %
Active power	P	30 to 2000 kW	±2 %
Power factor	PF	0 to 1	±2 %
Demand power	P demand	30 to 2000 kW	±2 %
Active energy	Ep	-10 ¹⁰ GWh to 10 ¹⁰ GWh	±2 %

Note: all current-based protection functions require no auxiliary source.
The test / reset button resets maximeters, clears the tripping indication and tests the battery.
[1] 0 to -40 % - [2] 0 to -60 %

Micrologic control units

Micrologic P "power"

A

Micrologic P control units include all the functions offered by Micrologic A. In addition, they measure voltages and calculate power and energy values. They also offer new protection functions based on currents, voltages, frequency and power reinforce load protection in real time.

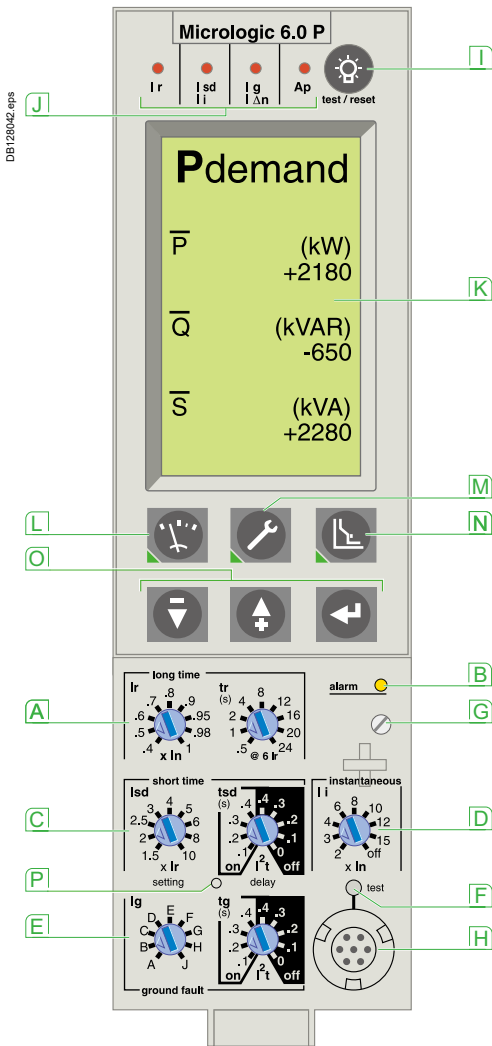

- A** long-time current setting and tripping delay
- B** overload signal (LED)
- C** short-time pick-up and tripping delay
- D** instantaneous pick-up
- E** earth-leakage or earth-fault pick-up and tripping delay
- F** earth-leakage or earth-fault test button
- G** long-time rating plug screw
- H** test connector
- I** lamp + battery test and indications reset
- J** indication of tripping cause
- K** high-resolution screen
- L** measurement display
- M** maintenance indicators
- N** navigation buttons
- O** navigation buttons
- P** hole for settings lockout pin on cover

Note: Micrologic P control units come with a non-transparent lead-seal cover as standard.

Protection

Protection settings

The adjustable protection functions are identical to those of Micrologic A (overloads, short-circuits, earth-fault and earth-leakage protection).

Fine adjustment

Within the range determined by the adjustment dial, fine adjustment of thresholds (to within one ampere) and time delays (to within one second) is possible on the keypad or remotely using the COM option.

IDMTL (Inverse Definite Minimum Time Lag) setting

Coordination with fuse-type or medium-voltage protection systems is optimised by adjusting the slope of the overload-protection curve. This setting also ensures better operation of this protection function with certain loads.

Neutral protection

On three-pole circuit breakers, neutral protection may be set using the keypad or remotely using the COM option, to one of four positions: neutral unprotected (4P 3d), neutral protection at 0.5 Ir (4P 3d + N/2), neutral protection at Ir (4P 4d) and neutral protection at 1.6 Ir (4P 3d + 1.6N). Neutral protection at 1.6 Ir is used when the neutral conductor is twice the size of the phase conductors (major load imbalance, high level of third order harmonics).

On four-pole circuit breakers, neutral protection may be set using a three-position switch or the keypad: neutral unprotected (4P 3d), neutral protection at 0.5 Ir (4P 3d + N/2), neutral protection at Ir (4P 4d). Neutral protection produces no effect if the long-time curve is set to one of the IDMTL protection settings.

Programmable alarms and other protection

Depending on the thresholds and time delays set using the keypad or remotely using the COM option, the Micrologic P control unit monitors currents and voltage, power, frequency and the phase sequence. Each threshold overrun is signalled remotely via the COM option. Each threshold overrun may be combined with tripping (protection) or an indication carried out by an optional I/O module (alarm), or both (protection and alarm).

Load shedding and reconnection

Load shedding and reconnection parameters may be set according to the power or the current flowing through the circuit breaker. Load shedding is carried out by a supervisor via the COM option or by I/O application module.

Indication option via I/O application module

I/O application module may be used to signal threshold overruns or status changes. They can be programmed using the COM option (BCM ULP) and Ecoreach software.

Communication option (COM)

The communication option may be used to:

- remotely read and set parameters for the protection functions
- transmit all the calculated indicators and measurements
- signal the causes of tripping and alarms
- consult the history files and the maintenance-indicator register
- maximeter reset.

An event log and a maintenance register, stored in control-unit memory but not available locally, may be accessed in addition via the COM option (BCM ULP).



Micrologic 5.0 / 6.0 / 7.0 P (Protection)

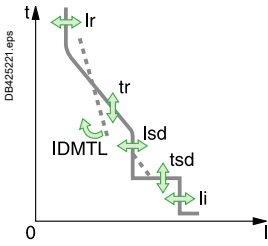

Long-time		ANSI Code 49												
Current setting (A)	$I_r = I_n \times \dots$	0.4	0.5	0.6	0.7	0.8	0.9	0.95	0.98	1	Other ranges or disable by changing long-time rating plug			
Tripping between 1.05 and 1.20 x Ir		tr (s)												
Time setting example:		0.5	1	2	4	8	12	16	20	24				
time delay (s)	Accuracy: 0 to -30 %	1.5 x Ir	12.5	25	50	100	200	300	400	500	600			
IDMTL (EIT)	Accuracy: 0 to -20 %	6 x Ir	0.7 ^[1]	1	2	4	8	12	16	20	24			
	Accuracy: 0 to -20 %	7.2 x Ir	0.7 ^[2]	0.69	1.38	2.7	5.5	8.3	11	13.8	16.6			
IDMTL setting	Curve slope	SIT	VIT	EIT	HVFuse	DT								
Thermal memory		20 minutes before and after tripping												
Short-time		ANSI Code 51												
Pick-up (A)	$I_{sd} = I_r \times \dots$	1.5	2	2.5	3	4	5	6	8	10				
Accuracy: ±10 %														
Time setting tsd (s)	Settings	I^2t Off	0	0.1	0.2	0.3	0.4							
		I^2t On	-	0.1	0.2	0.3	0.4							
Operating time at 10 x Ir	tsd (max resettable time)	20	80	140	230	350								
I^2t Off or I^2t On	tsd (max break time)	80	140	200	320	500								
Instantaneous		ANSI Code 50												
Pick-up (A)	$I_i = I_n \times \dots$	2	3	4	6	8	10	12	15	off				
Accuracy: ±10 %														
Operating time	max resettable time	20 ms												
	max break time	50 ms												

Micrologic 6.0 P (Protection)

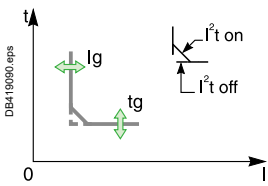

Earth fault		ANSI Code 51N												
Pick-up (A)	$I_g = I_n \times \dots$	A	B	C	D	E	F	G	H	J				
Accuracy: ±10 %														
	$I_n \leq 400$ A	0.3	0.3	0.4	0.5	0.6	0.7	0.8	0.9	1				
	400 A < I_n < 1250 A	0.2	0.3	0.4	0.5	0.6	0.7	0.8	0.9	1				
	$I_n \geq 1250$ A	500	640	720	800	880	960	1040	1120	1200				
Time setting tg (s)	Settings	I^2t Off	0	0.1	0.2	0.3	0.4							
		I^2t On	-	0.1	0.2	0.3	0.4							
Time delay (ms)	tg = max resettable time	20	80	140	230	350								
at In or 1200 A (I^2t Off or I^2t On)	tg = max break time	80	140	200	320	500								

Micrologic 7.0 P (Protection)

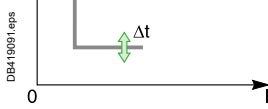

Residual earth leakage (Vigi) ANSI Code 51G													
Sensitivity (A)	$I_{\Delta n}$	0.5	1	2	3	5	7	10	20	30			
Accuracy: 0 to -20 %													
Time delay Δt (ms)	Settings	60	140	230	350	800							
	max resettable time	60	140	230	350	800							
	max break time	140	200	320	500	1000							

Micrologic 5.0 / 6.0 / 7.0 P (Alarms and other protection)

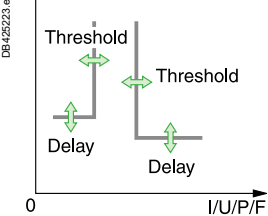

Current	ANSI Code 46	Threshold	Delay
Current unbalance	Iunbalance	0.05 to 0.6 Iaverage	1 to 40 s
Max. demand current	I _{max demand} : I1, I2, I3, IN	0.2 In to In	15 to 1500 s
Earth fault alarm			
	I_{\neq}	10 to 100 % In ^[3]	1 to 10 s
Voltage		ANSI Code	
Voltage unbalance	Uunbalance	47	2 to 30 % x Uaverage
Minimum voltage	Umin	27	100 to Umax between phases
Maximum voltage ^[4]	Umax	59	Umin to 1200 between phases
Power			
Reverse power	rP	32P	5 to 500 kW
Frequency			
Minimum frequency	Fmin	81L	45 to Fmax
Maximum frequency	Fmax	81H	Fmin to 440 Hz
Phase sequence			
Sequence (alarm)	ΔØ	Ø1/2/3 or Ø1/3/2	0.3 s

Micrologic 5.0 / 6.0 / 7.0 P (Load shedding and reconnection)

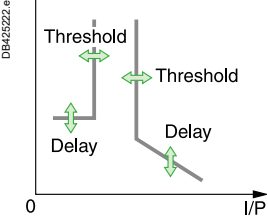

Measured value	Threshold	Delay
Current	I	0.5 to 1 Ir per phases
Power	P	200 kW to 10 MW

Micrologic 5.0 / 6.0 / 7.0 P (Power)

Type of measurements	Range	Accuracy
Current maximeters of	I1, I2, I3, IN	0.2 x In to 1.2 x In
Volatges	V12, V23, V31, V1N, V2N, V3N	100 to 690 V
Power factor	PF	0 to 1
Frequency (Hz)		± 0.1 %

[1] 0 to -40 % - [2] 0 to -60 % - [3] In ≤ 400 A 30 % 400 A < In < 1250 A 20 % In ≤ 1250 A 10 % -

[4] For 690 V applications, a step-down transformer must be used if the voltage exceeds the nominal value of 690 V by more than 10 %.

Note: all current-based protection functions require no auxiliary source.

Voltage-based protection functions are connected to AC power via a voltage measurement input built into the circuit breaker.

Micrologic control units

Micrologic P "power"

A

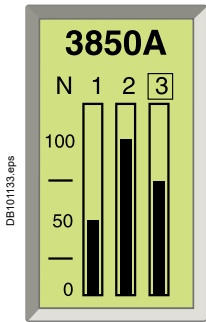

Default display.

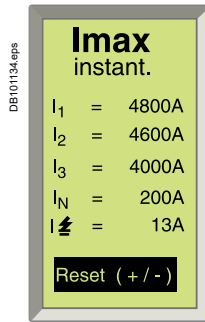

Display of a maximum current.

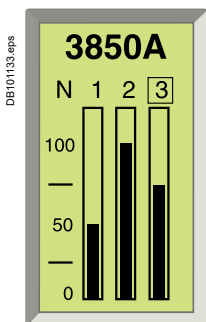

Display of a voltage.

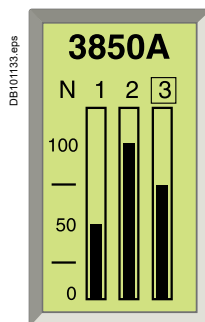

Display of a power.

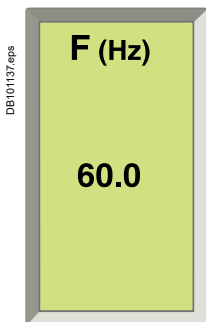

Display of a frequency.

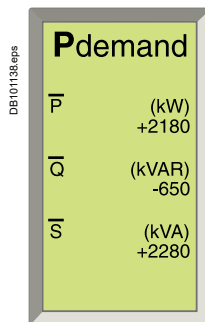

Display of a demand power.



PME software.

A-16

Life Is On



Measurements

The Micrologic P control unit calculates in real time all the electrical values (V, A, W, VAR, VA, Wh, VARh, VAh, Hz), power factors and cosφ factors.

The Micrologic P control unit also calculates demand current and demand power over an adjustable time period. Each measurement is associated with a minimeter and a maximeter.

In the event of tripping on a fault, the interrupted current is stored. The optional external power supply makes it possible to display the value with the circuit breaker open or not supplied.

Instantaneous values

The value displayed on the screen is refreshed every second.

Minimum and maximum values of measurements are stored in memory (minimeters and maximeters).

Currents

I _{rms}	A	1	2	3	N
				E-fault	E-leakage
I _{max rms}	A	1	2	3	N
				E-fault	E-leakage

Voltages

U _{rms}	V	12	23	31
V _{rms}	V	1N	2N	3N
U _{average rms}	V	(U12 + U23 + U31) / 3		
U _{unbalance}	%			

Power, energy

P _{active} , Q _{reactive} , S _{apparent}	W, Var, VA	Totals
E _{active} , E _{reactive} , E _{apparent}	Wh, VARh, VAh	Totals consumed - supplied
		Totals consumed
		Totals supplied
Power factor	PF	Total

Frequencies

F	Hz
---	----

Demand metering

The demand is calculated over a fixed or sliding time window that may be programmed from 5 to 60 minutes. According to the contract signed with the power supplier, an indicator associated with a load shedding function makes it possible to avoid or minimise the costs of overrunning the subscribed power. Maximum demand values are systematically stored and time stamped (maximeter).

Currents

I _{demand}	A	1	2	3	N
				E-fault	E-leakage
I _{max demand}	A	1	2	3	N
				E-fault	E-leakage

Power

P, Q, S _{demand}	W, Var, VA	Totals
P, Q, S _{max demand}	W, Var, VA	Totals

Minimeters and maximeters

Only the current and power maximeters may be displayed on the screen.

Time-stamping

Time-stamping is activated as soon as time is set manually or by a supervisor.

No external power supply module is required (max. drift of 1 hour per year).

Reset

An individual reset, via the keypad or remotely, acts on alarms, minimum and maximum data, peak values, the counters and the indicators.

Additional measurements accessible with the COM option (BCM ULP)

Some measured or calculated values are only accessible with the COM communication option:

- I_{peak} / √2, (I₁ + I₂ + I₃)/3, I_{unbalance}
- load level in % I_r
- total power factor.

The maximeters and minimeters are available only via the COM option (BCM ULP) for use with a supervisor.

Additional info

Accuracy of measurements (including sensors):

- voltage (V) 0.5 %
- current (A) 1.5 %
- frequency (Hz) 0.1 %
- power (W) and energy (Wh) 2 %.

Functions and characteristics

Micrologic control units

Micrologic P "power"

Histories and maintenance indicators

The last ten trips and alarms are recorded in two separate history files that may be displayed on the screen:

- tripping history:
 - type of fault
 - date and time
 - values measured at the time of tripping (interrupted current, etc.)
- alarm history:
 - type of alarm
 - date and time
 - values measured at the time of the alarm.

All the other events are recorded in a third history file which is only accessible through the communication network.

- Event log history (only accessible through the communication network)
 - modifications to settings and parameters
 - counter resets
 - system faults
 - fallback position
 - thermal self-protection
 - loss of time
 - overrun of wear indicators
 - test-kit connections
 - etc.

Note: all the events are time stamped: time-stamping is activated as soon as time is set manually or by a supervisor. No external power supply module is required (max. drift of 1 hour per year).

Maintenance indicators with COM option (BCM ULP)

A number of maintenance indicators may be called up on the screen to better plan for device maintenance:

- contact wear
- operation counter:
 - cumulative total
 - total since last reset.

Additional maintenance indicators are also available through the COM network, and can be used as an aid in troubleshooting:

- highest current measured
- number of test-kit connections
- number of trips in operating mode and in test mode.

Additional technical characteristics

Safety

Measurement functions are independent of the protection functions. The high-accuracy measurement module operates independently of the protection module.

Simplicity and multi-language

Navigation from one display to another is intuitive. The six buttons on the keypad provide access to the menus and easy selection of values. When the setting cover is closed, the keypad may no longer be used to access the protection settings, but still provides access to the displays for measurements, histories, indicators, etc. Micrologic is also multi-language, including the following languages: English, Spanish, Portuguese, Russian, Chinese, French, German...

Intelligent measurement

Measurement-calculation mode:

- energies are calculated on the basis of the instantaneous power values, in two manners:
 - the traditional mode where only positive (consumed) energies are considered
 - the signed mode where the positive (consumed) and negative (supplied) energies are considered separately
- measurement functions implement the new "zero blind time" concept which consists in continuously measuring signals at a high sampling rate. The traditional "blind window" used to process samples no longer exists. This method ensures accurate energy calculations even for highly variable loads (welding machines, robots, etc.).

Always powered

All current-based protection functions require no auxiliary source. Voltage-based protection functions are connected to AC power via a voltage measurement input built into the circuit breaker.

Stored information

The fine setting adjustments, the last 100 events and the maintenance register remain in the control-unit memory even when power is lost.

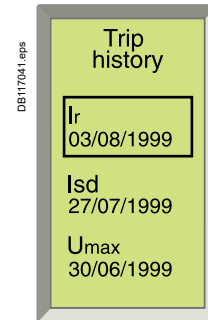

Display of a tripping history.

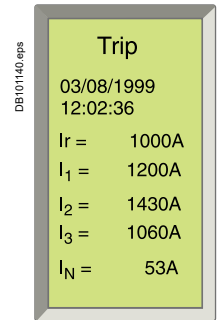

Display after tripping.

Functions and characteristics

Power Meter functions

Micrologic A/E/P control unit with COM option (BCM ULP) and COM Ethernet gateway

In addition to protection functions, Micrologic A/E/P control units offer all the functions of Power Meter products as well as operating-assistance for the circuit breaker.

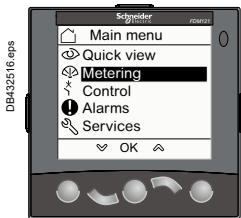

FDM121 display: navigation.

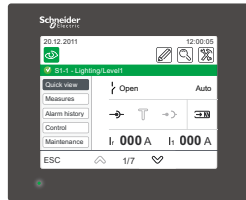

FDM128 display: navigation.

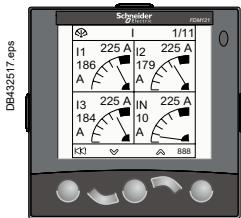

FDM121 display: current.

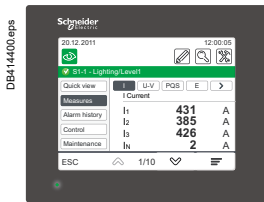

FDM128 display: current.

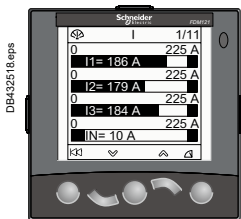

FDM121 display: voltage.

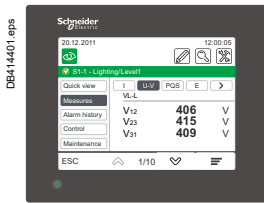

FDM128 display: voltage.

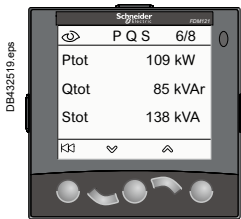

FDM121 display: power.

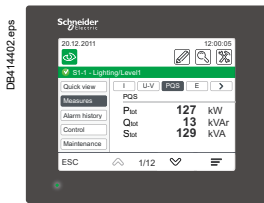

FDM128 display: power.

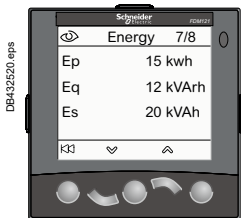

FDM121 display: consumption.

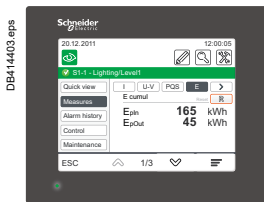

FDM128 display: consumption.

Examples of measurement screens on the FDM121 display unit.

Micrologic A/E/P measurement functions are made possible by Micrologic intelligence and the accuracy of the sensors. They are handled by a microprocessor that operates independent of protection functions.

Display

FDM121 display unit (one to one)

The FDM121 switchboard display unit can be connected to a COM option (BCM ULP) using a breaker ULP cord to display all measurements on a screen [1]. The result is a veritable 96 x 96 mm Power Meter.

The FMD121 display unit requires a 24 V DC power supply. The COM option (BCM ULP) unit is supplied by the same power supply via the breaker ULP cord connecting it to the FDM121.

[1] See page A-28.

FDM128 display unit (one to eight)

Using an IFE Ethernet interface for LV breakers.

For all FDM, in addition to the information displayed on the Micrologic LCD, the FDM screen shows demand, power quality and maximeter/minimeter values along with histories and maintenance indicators.

Measurements

Instantaneous rms measurements

The Micrologic continuously display the RMS value of the highest current of the three phases and neutral (Imax). The navigation buttons can be used to scroll through the main measurements.

In the event of a fault trip, the trip cause is displayed.

The Micrologic A measures phase, neutral, ground fault currents.

The Micrologic E offers voltage, power, Power Factor, measurements in addition to the measurements provided by Micrologic A.

The Micrologic P offer frequency, $\cos \phi$ in addition to the measurements provided by Micrologic E.

Maximeters / minimeters

Every instantaneous measurement provided by Micrologic A or E can be associated with a maximeter/minimeter. The maximeters for the highest current of the 3 phases and neutral, the demand current and power can be reset via the FDM display unit or the communication system.

Energy metering

The Micrologic E/P also measures the energy consumed since the last reset of the meter. The active energy meter can be reset via Micrologic keypad or the FDM display unit or the communication system.

Demand and maximum demand values

Micrologic E/P also calculates demand current and power values. These calculations can be made using a block or sliding interval that can be set from 5 to 60 minutes in steps of 1 minute. The window can be synchronised with a signal sent via the communication system. Whatever the calculation method, the calculated values can be recovered on a PC via Modbus communication.

Ordinary spreadsheet software can be used to provide trend curves and forecasts based on this data. They will provide a basis for load shedding and reconnection operations used to adjust consumption to the subscribed power.

Power Meter functions

Micrologic A/E/P control unit with COM option (BCM ULP) and COM Ethernet gateway



Micrologic A/E/P integrated Power Meter functions			Type	Display
			A/E	P
				Micrologic LCD
				FDM display
Display of protection settings				
Pick-ups (A) and delays	All settings can be displayed	Ir, tr, lsd, tsd, li, lg, tg	A/E	P
Measurements				
Instantaneous rms measurements				
Currents (A)	Phases and neutral	I1, I2, I3, IN	A/E	P
	Average of phases	$I_{avg} = (I1 + I2 + I3) / 3$	A/E	P
	Highest current of the 3 phases and neutral	I_{max} of I1, I2, I3, IN	A/E	P
	Ground fault (Micrologic 6)	% Ig (pick-up setting)	A/E	P
	Current unbalance between phases	% Iavg	-/E	P
Voltages (V)	Phase-to-phase	V12, V23, V31	-/E	P
	Phase-to-neutral	V1N, V2N, V3N	-/E	P
	Average of phase-to-phase voltages	$V_{avg} = (V12 + V23 + V31) / 3$	-/E	P
	Average of phase-to-neutral voltages	$V_{avg} = (V1N + V2N + V3N) / 3$	-/E	P
	Ph-Ph and Ph-N voltage unbalance	% Vavg and % Vavg	-/E	P
	Phase sequence	1-2-3, 1-3-2	-/-	P
Frequency (Hz)	Power system	f	-/-	P
Power	Active (kW)	P, total	-/E	P
		P, per phase	-/E	P
	Reactive (kVAR)	Q, total	-/E	P
		Q, per phase	-/-	P
	Apparent (kVA)	S, total	-/E	P
		S, per phase	-/-	P
	Power Factor	PF, total	-/E	P
		PF, per phase	-/-	P
Cos.φ	Cos.φ, total	-/-	P	
	Cos.φ, per phase	-/-	P	
Maximeters / minimeters				
	Associated with instantaneous rms measurements	Reset via FDM display unit and Micrologic keypad	A/E	P
Energy metering				
Energy	Active (kW), reactive (kVARh), apparent (kVAh)	Total since last reset	-/E	P
Demand and maximum demand values				
Demand current (A)	Phases and neutral	Present value on the selected window	-/E	P
		Maximum demand since last reset	-/E	P
Demand power	Active (kWh), reactive (kVAR), apparent (kVA)	Present value on the selected window	-/E	P
		Maximum demand since last reset	-/E	P
Calculation window	Sliding, fixed or com-synchronised	Adjustable from 5 to 60 minutes in 1 minute steps [1]	-/E	P

[1] Available via the communication system only.

[2] Available for Micrologic P only.

[3] FDM121 only.

Operating-assistance functions

Micrologic A/E/P control unit with COM option (BCM ULP)



Histories

- Trip indications in clear text in a number of user-selectable languages.
- Time-stamping: date and time of trip.

Maintenance indicators

Micrologic control unit have indicators for, among others, the number of operating cycles, contact wear P, load profile and operating times (operating hours counter) of the MasterPact circuit breaker.

It is possible to assign an alarm to the operating cycle counter to plan maintenance. The various indicators can be used together with the trip histories to analyse the level of stresses the device has been subjected to.

Management of installed devices

Each circuit breaker equipped with a COM option (BCM ULP) can be identified via the communication system:

- serial number
- firmware version
- hardware version
- device name assigned by the user.

This information together with the previously described indications provides a clear view of the installed devices.

Micrologic A/E/P operating assistance functions			Type	Display		
			A/E	P	Micrologic LCD	FDM121 display
Operating assistance						
Trip history						
Trips	Cause of tripping	Ir, I _{sd} , I _i , I _g , I Δ n	- / E	P	●	●
Maintenance indicators						
Counter	Mechanical cycles	Assignable to an alarm	A/E	P	-	●
	Electrical cycles	Assignable to an alarm	A/E	P	-	●
	Hours	Total operating time (hours) ^[1]	A/E	P	-	-
Indicator	Contact wear	%	- / -	P	-	●
Load profile	Hours at different load levels	% of hours in four current ranges: 0-49 % I _n , 50-79 % I _n , 80-89 % I _n and ≥ 90 % I _n	A/E	P	-	●

[1] Also available via the communication system.

Additional technical characteristics

Contact wear

Each time ComPact opens, the Micrologic P trip unit measures the interrupted current and increments the contact-wear indicator as a function of the interrupted current, according to test results stored in memory. Breaking under normal load conditions results in a very slight increment. The indicator value may be read on the FDM121 display. It provides an estimation of contact wear calculated on the basis of the cumulative forces affecting the circuit breaker. When the indicator reaches 100 %, it is advised to inspect the circuit breaker to ensure the availability of the protected equipment.

Circuit breaker load profile

Micrologic A/E/P calculates the load profile of the circuit breaker protecting a load circuit. The profile indicates the percentage of the total operating time at four current levels (% of breaker I_n):

- 0 to 49 % I_n
- 50 to 79 % I_n
- 80 to 89 % I_n
- ≥ 90 % I_n.

This information can be used to optimise use of the protected equipment or to plan ahead for extensions.

Switchboard-display functions

Micrologic A/E/P control unit with COM option (BCM ULP)

A

Micrologic measurement capabilities come into full play with the FDM121 switchboard display. It connects to COM option (BCM ULP) via a breaker ULP cord and displays Micrologic information. The result is a true integrated unit combining a circuit breaker and a Power Meter. Additional operating assistance functions can also be displayed.

FDM121 switchboard display

An FDM121 switchboard display unit can be connected to a ULP IMU using a prefabricated cord to display all measurements, alarms, histories and event tables, maintenance indicators, management of installed devices on a screen. The result is a veritable 96 x 96 mm Power Meter.

The FDM121 display unit requires a 24 V DC power supply.

The FDM121 is a switchboard display unit that can be integrated in the ComPact NSX100 to 630 A, PowerPact H/J/L/P/R, ComPact NS or MasterPact systems. It uses the sensors and processing capacity of the Micrologic trip unit. It is easy to use and requires no special software or settings. It is immediately operational when connected to the ComPact NSX by a simple cord.

Also, it provides monitoring and control with the use of the I/O application module, the motor mechanism module, or the Breaker Status module.

The FDM121 is a large display, but requires very little depth. The anti-glare graphic screen is backlit for very easy reading even under poor ambient lighting and at sharp angles.

Display of Micrologic measurements and alarms

The FDM121 is intended to display Micrologic 5 / 6 measurements, alarms and operating information. It cannot be used to modify the protection settings. Measurements may be easily accessed via a menu. All user-defined alarms are automatically displayed. The display mode depends on the priority level selected during alarm set-up:

- high priority: a pop-up window displays the time-stamped description of the alarm and the orange LED flashes
- medium priority: the orange "Alarm" LED goes steady on
- low priority: no display on the screen.

All faults resulting in a trip automatically produce a high-priority alarm, without any special settings required. In all cases, the alarm history is updated. Micrologic saves the information in its non-volatile memory in the event of an FDM121 power failure.

Status indications and remote control

When the circuit breaker is equipped with the Breaker Status Module, the FDM121 display can also be used to view circuit breaker status conditions:

- O/F: ON/OFF
- SD: trip indication
- SDE: Fault-trip indication (overload, short-circuit, ground fault).

When the circuit breaker system is equipped with the I/O application module, the FDM121 can monitor and control:

- cradle management
- circuit breaker operation
- light and load control
- custom application.

When the circuit breaker system is equipped with the motor mechanism module, the FDM121 offers remote closing and opening control.

Main characteristics

- 96 x 96 x 30 mm screen requiring 10 mm behind the door (or 20 mm when the 24 V power supply connector is used).
- White backlighting.
- Wide viewing angle: vertical $\pm 60^\circ$, horizontal $\pm 30^\circ$.
- High resolution: excellent reading of graphic symbols.
- Alarm LED: flashing orange for alarm pick-up, steady orange after operator reset if alarm condition persists.
- Operating temperature range -10°C to $+55^\circ\text{C}$.
- CE / UL / CSA marking (pending).
- 24 V DC power supply, with tolerances 24 V -20% (19.2 V) to 24 V $+10\%$ (26.4 V). When the FDM121 is connected to the communication network, the 24 V DC can be supplied by the communication system wiring system.
- Consumption 40 mA.

Mounting

The FDM121 is easily installed in a switchboard.

- Standard door cut-out 92 x 92 mm.
- Attached using clips.

To avoid a cut-out in the door, an accessory is available for surface mounting by drilling only two 22 mm diameter holes. The FDM121 degree of protection is IP54 in front. IP54 is maintained after switchboard mounting by using the supplied gasket during installation.

Connection

The FDM121 is equipped with:

- a 24 V DC terminal block:
 - plug-in type with 2 wire inputs per point for easy daisy-chaining
 - power supply range of 24 V DC -20% (19.2 V) to 24 V DC $+10\%$ (26.4 V).

A 24 V DC type auxiliary power supply must be connected to a single point on the ULP system. The FDM121 display unit has a 2-point screw connector on the rear panel of the module for this purpose. The ULP module to which the auxiliary power supply is connected distributes the supply via the ULP cable to all the ULP modules connected to the system and therefore also to Micrologic.

- two RJ45 jacks.

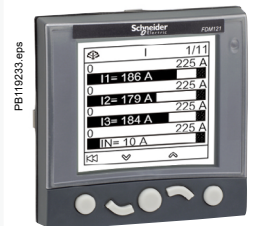

FDM121 display.

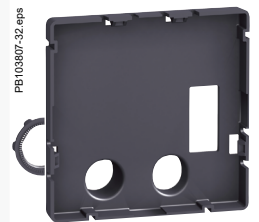

Surface mount accessory.



Connection with FDM121 display unit.

Switchboard-display functions

Micrologic A/E/P control unit with COM option (BCM ULP)

A

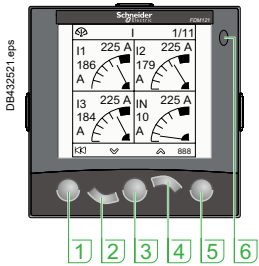

- 1 escape
- 2 down
- 3 ok
- 4 up
- 5 context
- 6 alarm LED

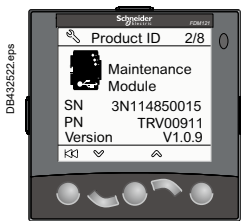

Product identification.

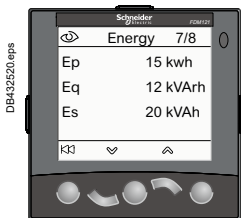

Metering: meter.

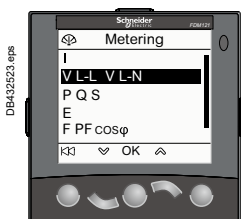

Metering: sub-menu.

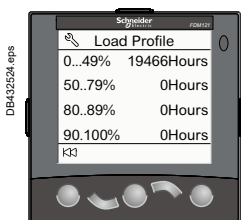

Services.

The Micrologic connects to the internal communication terminal block on the MasterPact via the breaker ULP cord. Connection to one of the RJ45 connectors on the FDM121 automatically establishes communication between the Micrologic and the FDM121 and supplies power to the Micrologic measurement functions. When the second connector is not used, it must be fitted with a line terminator.

Navigation

Five buttons are used for intuitive and fast navigation.

The "Context" button may be used to select the type of display (digital, bargraph, analogue).

The user can select the display language (Chinese, English, French, German, Italian, Portuguese, Spanish, etc.).

Screens

Main menu

When powered up, the FDM121 screen automatically displays the ON/OFF status of the device.



When not in use, the screen is not backlit. Backlighting can be activated by pressing one of the buttons. It goes off after 3 minutes.

Fast access to essential information

"Quick view" provides access to five screens that display a summary of essential operating information (I, U, f, P, E, THD, circuit breaker On / Off).

Access to detailed information

"Metering" can be used to display the measurement data (I, U-V, f, P, Q, S, E, THD, PF) with the corresponding min/max values.

Alarms displays active alarms and the alarm history.

Services provides access to the operation counters, energy and maximeter reset

function, maintenance indicators, identification of modules connected to the internal bus and FDM121 internal settings (language, contrast, etc.).

Communication components and FDM121 connections

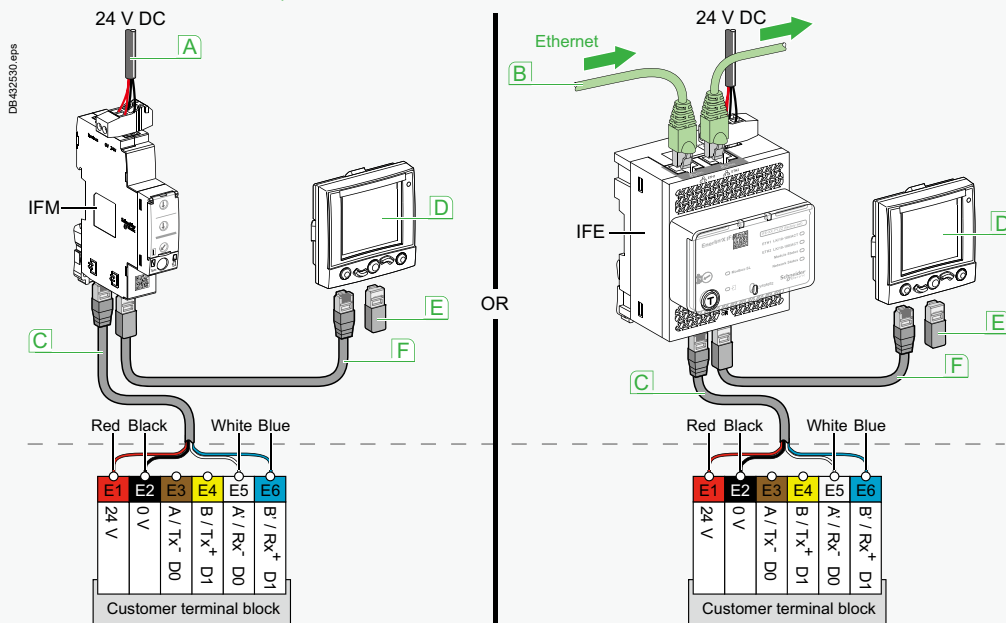

- A Modbus network
- B Ethernet network
- C Breaker ULP cord

- D FDM121 display
- E ULP termination
- F ULP cable

Connections

Compact NS is connected to the ULP devices (FDM121 display, IFM, IFE or I/O application module) unit via the breaker ULP cord.

cord available in three lengths: 0.35 m, 1.3 m, 3 m and 5 m.

lengths up to 10 m possible using extensions.

Switchboard-display functions

Micrologic A/E/P control unit with COM Ethernet gateway

A

Micrologic measurement capabilities come into full play with the FDM128 switchboard display. It connects to Ethernet communication via RJ45 port and displays Micrologic information. The result is a true integrated unit combining a circuit breaker and a Power Meter. Additional operating assistance functions can also be displayed.

FDM128 switchboard display

The FDM128 is an intelligent Ethernet display. It collects the data from up to 8 devices via Ethernet network. The FDM128 switchboard display unit can be connected to a Micrologic COM option (BCM ULP via IFE). It uses the sensors and processing capacity of the Micrologic control unit. It is easy to use and requires no special software or settings.

The FDM128 is a large display, but requires very little depth. The anti-glare graphic screen is backlit for very easy reading even under poor ambient lighting and at sharp angles.

FDM128 switchboard display is designed to manage up to 8 devices (MasterPact, ComPact NS, ComPact NSX or Smartlink).

Display of Micrologic measurements and trips

The FDM128 is intended to display Micrologic A/E/P measurements, trips and operating information.

It cannot be used to modify the protection settings.

Measurements may be easily accessed via a menu.

Trips are automatically displayed.

A pop-up window displays the time-stamped description of the trip.

Status indications

When the circuit breaker is equipped with the Breaker Status Command Module (BSCM) and NSX cord, the FDM128 display can also be used to view circuit breaker status conditions:

- O/F: ON/OFF
- SDE: Fault-trip indication (overload, short-circuit, ground fault)
- CE, CD, CT cradle management with I/O application module.

Remote control

When the circuit breaker is equipped with the COM option (BCM ULP) (including its kit for connection to communication voltage releases), the FDM128 display can also be used to control (open/close) the circuit breaker.

Two operating mode are available:

- local mode : open/close commands are enabled from FDM128 while disable from communication network
- remote mode : open/close commands are disabled from FDM128 while, enabled from communication network.

Main characteristics

- 115.2 x 86.4 mm with 5.7" QVGA display 320 x 240 pixels.
- Color TFT LCD, LED backlight.
- Wide viewing angle: vertical $\pm 80^\circ$, horizontal $\pm 70^\circ$.
- High resolution: excellent reading of graphic symbols.
- Operating temperature range -10 °C to +55 °C.
- CE / UL / CSA marking (pending).
- 24 V DC power supply, with tolerances 24 V (limit 20.4 - 28.8 V DC).
- Consumption ≤ 6.8 W.

Mounting

The FDM128 is easily installed in a switchboard.

- Standard door hole $\varnothing 22$ mm.

The FDM128 degree of protection is IP65 in front and IP54.

Connection

The FDM128 is equipped with:

- a 24 V DC terminal block:
 - power supply range of 24 V DC (limit 20.4 - 28.8 V DC). The FDM128 display unit has a 2-point screw connector on the rear panel of the module for this purpose.
- One RJ45 Ethernet jacks.

The Micrologic connects to the internal communication terminal block on the MasterPact via the breaker ULP cord and Ethernet connection through IFE.



FDM128 display.

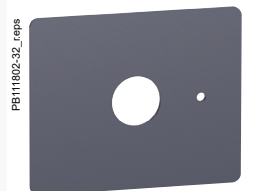

Surface mount accessory.



Switchboard-display functions

Micrologic A/E/P control unit with COM Ethernet gateway

A

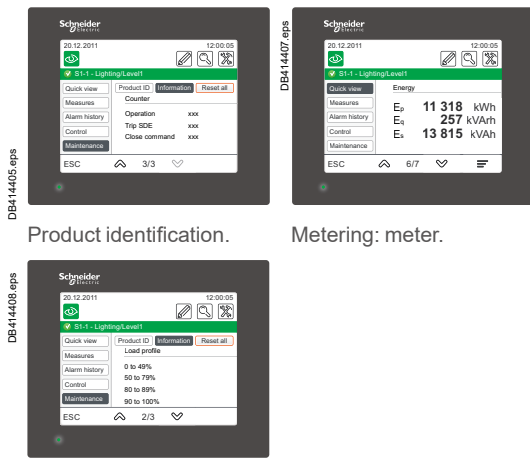

Product identification.

Metering: meter.

Services.

Navigation

Touch screen is used for intuitive and fast navigation.

The user can select the display language (Chinese, English, French, German, Italian, Portuguese, Spanish, etc.).

Screens

Main menu

-  Quick view
-  Alarms
-  Metering
-  Maintenance.
-  Control

When not in use, the screen is automatically shifted to low back-lighting.

Fast access to essential information

■ "Quick view" provides access to five screens that display a summary of essential operating information (I, U, f, P, E, THD, circuit breaker On / Off).

Access to detailed information

- "Metering" can be used to display the measurement data (I, U-V, f, P, Q, S, E, THD, PF) with the corresponding min/max values.
- Alarms displays the trip history.
- Services provides access to the operation counters, energy and maximeter reset function, maintenance indicators, identification of modules connected to the internal bus and FDM128 internal settings (language, contrast, etc.).

Protection of distribution systems

Micrologic control units for ComPact NS630b to 3200



External sensors

External sensor for earth-fault and neutral protection

The sensors, used with the 3P circuit breakers, are installed on the neutral conductor for:

- neutral protection (with Micrologic P)
- residual type earth-fault protection (with Micrologic A, E and P).

The rating of the sensor (CT) must be compatible with the rating of the circuit breaker:

- NS630b to 1600 A - 400/1600 CT
- NS1600b to 3200 A - 1000/4000 CT.

Rectangular sensor for earth-leakage protection

The sensor is installed around the busbars (phases + neutral) to detect the zero-phase sequence current required for the earth-leakage protection. Rectangular sensors are available in two sizes.

Inside dimensions (mm)

- 280 x 115 up to 1600 A for ComPact NS630b to 1600 A (L1)
- 470 x 160 up to 3200 A for ComPact NS1600b to 3200 A (L2).

External sensor for source ground return protection

The sensor is installed around the connection of the transformer neutral point to earth and connects to the Micrologic 6.0 control unit via an MDGF module to provide the source ground return (SGR) protection.

Long-time rating plug

Four interchangeable plugs may be used to limit the long-time threshold setting range for higher accuracy.

The time delay settings indicated on the plugs are for an overload of 6 Ir (for further details, see the characteristics on [page A-13](#) and [page A-17](#)).

As standard, control units are equipped with the 0.4 to 1 plug.

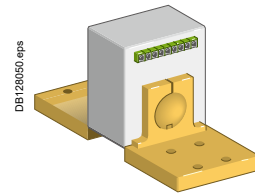

External sensor (CT).



External sensor for earth leakage protection.



Long-time rating plug.

Setting ranges

Standard	$I_r = I_n \times \dots$	0.4	0.5	0.6	0.7	0.8	0.9	0.95	0.98	1
Low-setting option	$I_r = I_n \times \dots$	0.4	0.45	0.50	0.55	0.60	0.65	0.70	0.75	0.8
High-setting option	$I_r = I_n \times \dots$	0.80	0.82	0.85	0.88	0.90	0.92	0.95	0.98	1
Off plug		No long-time protection ($I_r = I_n$ for Isd setting)								

Important: long-time rating plugs must always be removed before carrying out insulation or dielectric withstand tests.

Battery module

The battery module maintains display operation and communication with the supervisor if the power supply to the Micrologic control unit is interrupted.

It is installed in series between the Micrologic control unit and the AD module.

Characteristics

- Battery run-time: 4 hours (approximately).
- Mounted on vertical backplate or symmetrical rail.



Battery module.

Spare parts

Lead-seal covers

A lead-seal cover controls access to the adjustment dials.

When the cover is closed:

- it is impossible to modify settings using the keypad unless the settings lockout pin on the cover is removed
- the test connector remains accessible
- the test button for the earth-fault and earth-leakage protection function remains accessible.

Characteristics

- Transparent cover for basic Micrologic and Micrologic A, E control units.
- Non-transparent cover for Micrologic P control units.

Spare battery

A battery supplies power to the LEDs identifying the tripping causes. Battery service life is approximately ten years.

A test button on the front of the control unit is used to check the battery condition.

The battery may be replaced on site when discharged.

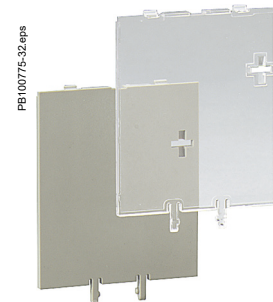

Lead-seal cover.

A

PB100837-68.eps



Portable test kit.

LV45444.eps



External 24 V DC power supply module (AD)

Test equipment

Hand-held test kit

The hand-held mini test kit may be used to:

- check operation of the control unit and the tripping and pole-opening system by sending a signal simulating a short-circuit
- supply power to the control units for settings via the keypad when the circuit breaker is open (Micrologic P control units).

Power source: standard LR6-AA battery.

Full function test kit

The test kit can be used alone or with a supporting personal computer.

The test kit without PC may be used to check:

- the mechanical operation of the circuit breaker
- the electrical continuity of the connection between the circuit breaker and the control unit

operation of the control unit:

- display of settings
- automatic and manual tests on protection functions
- test on the zone-selective interlocking (ZSI) function
- inhibition of the earth-fault protection
- inhibition of the thermal memory.

The test kit with PC offers in addition:

- the test report (software available on request).

External 24 V DC power-supply module (AD)

The external power-supply module makes it possible:

- to use the display even if the circuit breaker is open or not supplied (for the exact conditions of use, see the "electrical diagrams" part of this catalogue)
- to display fault currents after tripping
- to modify settings when the circuit breaker is open (OFF position)

An external 24 V DC power supply is required for installation with communication, whatever the type of trip unit.

This module is not designed to power on 24 V DC voltage releases and electric motor mechanism.

This module powers both the control unit and the M2C programmable contacts.

We recommended using the AD power supply due to its low stray primary secondary capacitance. Good operation of the Micrologic control unit in noisy environment is not guaranteed with other power supplies.

If the COM option is used, a second dedicated power supply shall be used.

Characteristics

- Power supply AC-to-DC or DC-to-DC
- Output voltage: 24 V DC $\pm 5\%$.
- Output current: 1 A.
- DIN rail or platine Fixing with Acti9 form factor
- Conducted emissions power line: class B per EN 61000-6-3.

24 V DC Universal Phaseo™ ABL8 power supplies

The Universal Phaseo ABL8 RPS 24050 and ABL8 RPS 24030 power supplies can be connected phase-to-neutral or phase-to-phase. They deliver a voltage that is precise to 3 %, whatever the load and whatever the value of the AC supply, within the ranges 85 to 132 V AC and 170 to 550 V AC. The Universal Phaseo ABL8 powers:

- circuit breaker communication module and interface.

Characteristics

- Power supply AC-to-DC.
- Network frequency: 50/60 Hz (±5 %).
- Output voltage: 24 V DC ±3%.
- Output current: 3 or 5 A.
- DIN rail or platine Fixing.
- Conducted emissions power line: class B per EN 61000-6-3.

To assist cooling there must be sufficient clearance around the Universal range Phaseo power supplies:

- 50 mm above and below
- 10 mm on the side.

		ABL8RPS●●●●	Module AD
Over Voltage Category		Cat I per VDE 0106-1	Cat IV per IEC 62477-1 (AC model) Cat III per IEC 62477-1 (DC model) Cat III per UL 61010-1
Degree of pollution as per IEC 60664-1		2	3
Input supply voltage AC		100...120 V AC and 200...500 V AC	110/130 or 200/240 V AC
Input supply voltage DC		N/A	24/30 or 48/60 or 100/125 V DC
Dielectric	Input/Output	4 kV rms -1 mn.	3 kV rms - 1 mn. (110/130 V AC and 200/240 V AC model) 3 kV rms - 1 mn. (110/125 V DC model) 2 kV rms - 1 mn. (24/30 V DC and 48/60 V DC model)
	Input/Ground	3.5 kV rms -1 mn.	3 kV rms - 1 mn.
	Output /Ground	0,5 kV rms - 1 mn.	1.5 kV rms - 1 mn.
Temperature		<ul style="list-style-type: none"> ■ 50 °C ■ 60 °C with 80 % of the rated current maximum 	70°C
Output current		3 A (ABL8RPS24030) 5 A (ABL8RPS24050)	1 A
Inrush current for 2 ms		< 30 A	< 20 A
Ripple		200 mV peak-peak	200 mV peak-peak
Output voltage limits		24 to 28.8 V DC	22.8 to 25.2 V DC
Protection degree		IP20	IP4x front face / IP2x terminals / IP3x other

Note: For the applications requiring an over voltage category higher than 2, a surge arrester shall be associated to ABL8 RPS power supplies. The iQuick20prd type 2 surge arrester is recommended.



ABL8 RPS power supply

PF1003495E_ABL8RPS24050_rps



Functions and characteristics

Enerlin'X communication system

Products overview

A

Enerlin'X communication system provides access to status, electrical values and devices control using Ethernet and Modbus SL communication protocols.

Ethernet has become the universal link between switchboards, computers and communication devices inside the building. The large amount of information which can be transferred makes the connection of Enerlin'X digital system to hosted web services of Schneider Electric a reality. More advantages are offered to integrators thanks to configuration web pages available remotely or on the local Ethernet network.

Modbus SL is the most widely used communication protocol in industrial networks. It operates in master-slave mode. The devices (slaves) communicate one after the other with a gateway (master).

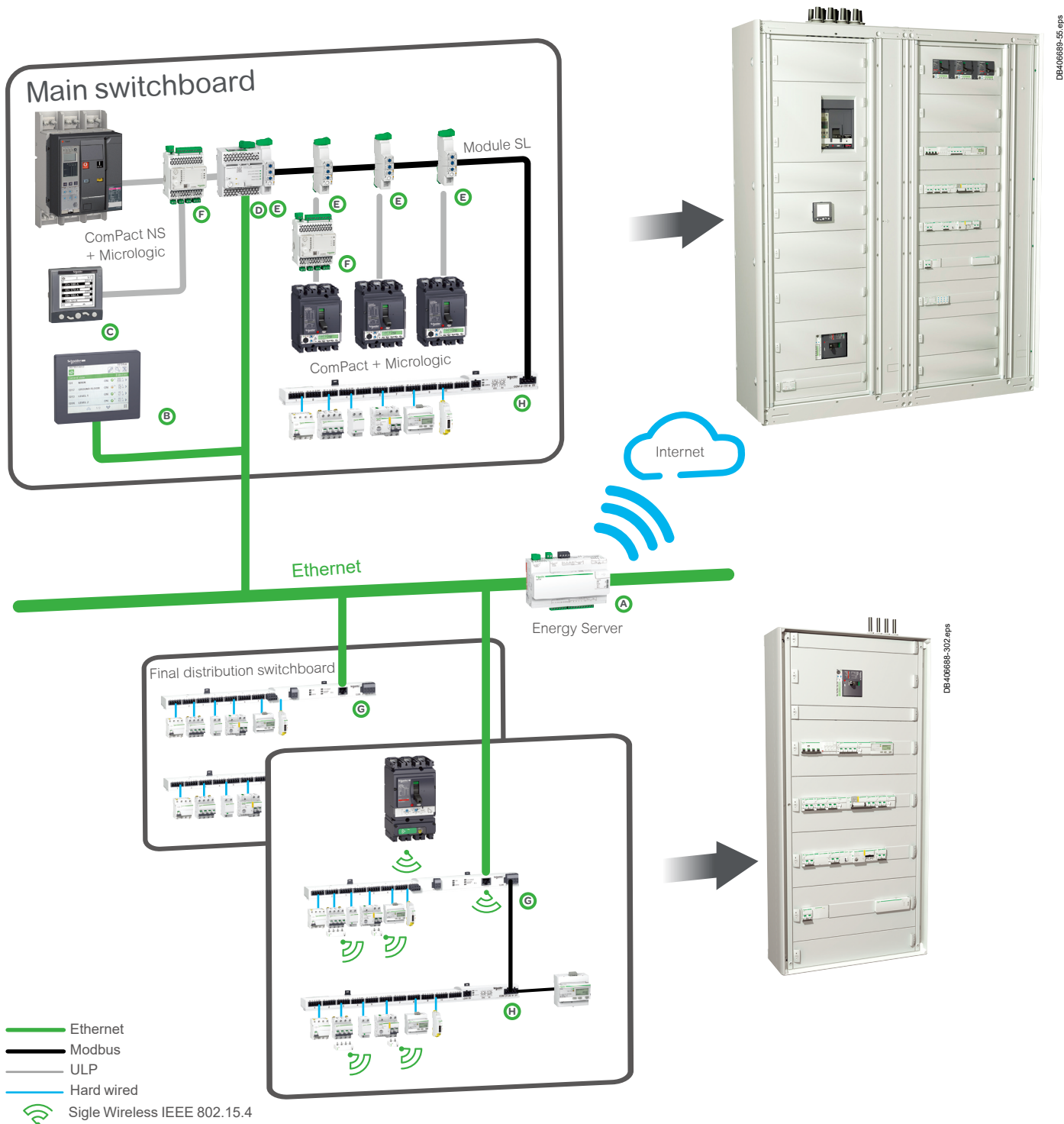

DB40688-55 eps







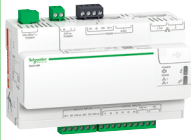

DB40688-302 eps

Functions and characteristics

Enerlin'X communication system

Products overview

A

Enerlin'X digital devices and displays								
	Name	Function	Port (to device)	(to server)	Inputs	Outputs	Cial. Ref.	
A		Com'X 210	Energy data logger + Ethernet Gateway	Ethernet Modbus Master,	Ethernet cable + WiFi	64 devices: 6 binary 2 analog 32 Modbus devices + other Ethernet devices (Modbus TCP)	-	EBX210
		Com'X 510 24 V DC + PoE	Energy server + Ethernet Gateway	Zigbee (to wireless meters)			-	EBX510
B		FDM128	Ethernet LCD colour touch screen	-	Ethernet		-	LV434128
C		FDM121	LCD display for circuit breaker	ULP	-	1 circuit breaker	-	TRV00121
D		IFE Switchboard server	Switchboard server	Modbus Master & ULP	Ethernet	20 circuit breakers	-	LV434002
		IFE interface	Ethernet interface for circuit breakers	ULP	Ethernet	1 circuit breaker	-	LV434001
E		IFM	Modbus interface for circuit breaker	ULP	Modbus Slave	1 circuit breaker	-	LV434000
F		I/O	Input/Output application module for circuit breaker	ULP	ULP	6 binary 1 analog (PT100 sensor)	3	LV434063
G		Acti 9 Smartlink SI B Ethernet wireless	Ethernet server for I/O and Modbus slave devices	Modbus Master & Wireless to PowerTag	Ethernet	14 binary 2 analog	7	A9XMZA08
H		Acti 9 Smartlink Modbus slave	Modbus interface with Input/Output functions	-	Modbus Slave	22 binary	11	A9XMSB11

Ethernet Gateway or Interface: routes an internal traffic (ULP or other protocole) to the Internet, the outgoing messages are coded with Modbus TCP/IP protocol.

Server (Switchboard, Energy): routes the internal traffic to the Internet. Other complementary functions such as data logging and storage. Provides devices status and energy trends on internal web pages...

Communication

Communication wiring system

A

Wiring system ULP

The wiring system is designed for low-voltage power switchboards. Installation requires no tools or special skills. The prefabricated wiring ensures both data transmission (Modbus protocol) and 24 V DC power distribution for the communications modules on the Micrologic control units.

PE119237.eps

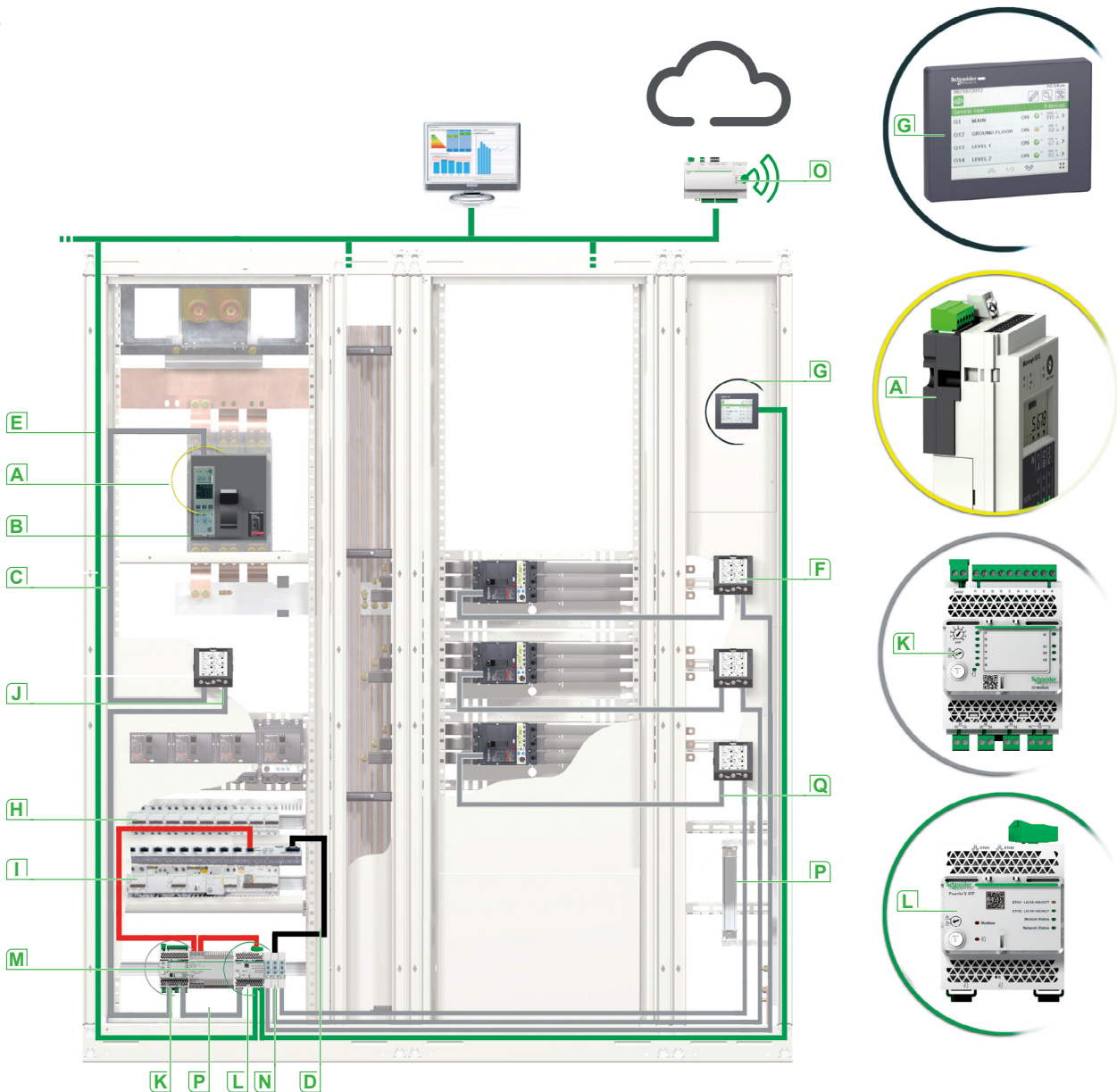

- A** BCM ULP: Breaker Communication Module with ULP port
- B** Micrologic control unit
- C** Breaker ULP cord

0.35 m	LV434195
1.3 m	LV434196
3 m	LV434197
5 m	LV434198
- D** Modbus cable
- E** Ethernet cable
- F** FDM121: Front Display Module TRV00121
- G** FDM128: Front Display Module LV434128
- H** Smartlink A9XMSB11
- I** Acti9
- J** ULP line terminators TRV00880
- K** I/O (Input/Output) application module LV434063

- L** IFE: Ethernet interface LV434001 or LV434002
 - M** External 24 V DC power supply module LV434000
 - N** IFM: Modbus-SL interface LV434000
 - O** Com'X 210
 - P** ULP cable

0.3 m	TRV00803
0.6 m	TRV00806
1 m	TRV00810
2 m	TRV00820
3 m	TRV00830
5 m	TRV00850
0.35 m	LV434200
1.3 m	LV434201
3 m	LV434202
 - Q** NSX cord

0.35 m	LV434200
1.3 m	LV434201
3 m	LV434202
- Ethernet
— Modbus
— ULP
— 24 V DC

Communication

Overview of functions



Four functional levels

The ComPact can be integrated into a Modbus communication environment. There are four possible functional levels that can be combined.

	Switch-disconnectors	Circuit breaker
Status indications		
ON/OFF (O/F)	○	S A E P
Spring charged CH	○	S A E P
Ready to close	○	S A E P
Fault-trip SDE	○	S A E P
Connected / disconnected / test position	○	S A E P
CE/CD/CT (I/O application module only)		S A E P
Controls		
MX open release	○	S A E P
Closing release	○	S A E P
Measurements		
Instantaneous measurement information	○	A E P
Averaged measurement information	○	E P
Maximeter / minimeter	○	A E P
Energy metering	○	E P
Demand for current and power	○	E P
Power quality	○	
Operating assistance		
Protection and alarm settings		A E P
Histories		A E P
Time stamped event tables		A E P
Maintenance indicators		A E P

Modbus principle

The Modbus RS 485 (RTU protocol) system is an open bus on which communicating Modbus devices (ComPact NS with Modbus COM, Power Meter PM700, PM800, Sepam, Vigilohm, ComPact NSX, etc.) are installed. All types of PLCs and microcomputers may be connected to the bus.

Addresses

The Modbus communication parameters (address, baud rate, parity) are entered using the keypad on the Micrologic A, E, P, H. For a switch-disconnector, it is necessary to use the Electrical Asset Manager or RSU (Remote Setting Utility) Micrologic utility.

Number of devices

The maximum number of devices that may be connected to the Modbus bus depends on the type of device (ComPact with Modbus COM, PM700, PM800, Sepam, Vigilohm, ComPact NSX, etc.), the baud rate (19200 is recommended), the volume of data exchanged and the desired response time. The RS 485 physical layer offers up to 32 connection points on the bus (1 master, 31 slaves).

A fixed device requires only one connection point (communication module on the device). A drawout device uses two connection points (communication modules on the device and on the chassis).

The number must never exceed 31 fixed devices or 15 drawout devices.

Length of bus

The maximum recommended length for the Modbus bus is 1200 meters.

Bus power source

A 24 V DC power supply is required (less than 20 % ripple, insulation class II).

Ethernet principle

Ethernet is a data link and physical layer protocol defined by IEEE 802.10 and 100 Mbps specifications that connects computer or other Ethernet devices. Ethernet is an asynchronous Carrier Sense Multiple Access with Collision detection (referred as CSMA/CD) protocol. Carrier Sense means that the hosts can detect whether the medium (coaxial cable) is idle or busy. Multiple Access means that multiple hosts can be connected to the common medium. Collision Detection means a host detects whether its transmission has collided with the transmission of another host (or hosts).

IFE Ethernet interface can be connected to a PC or a laptop over Ethernet. The maximum length of Ethernet cable is 100 meters. IFE Ethernet interface + gateway provides a Modbus TCP/IP gateway over Ethernet to enable Modbus TCP communication from a Modbus TCP master to any Modbus slave devices connected to it. The maximum active Modbus TCP client connection is twelve.

IFE Ethernet interface has an embedded web server (web page).

The Modbus RS 485 (RTU protocol) system is an open bus on which communicating Modbus devices (ComPact NS with Modbus COM, Power Meter PM700, PM800, Sepam, Vigilohm, ComPact NSX, etc.) are installed. All types of PLCs and microcomputers may be connected to the bus.

PB104863 eps



- S: Micrologic without measurement.
- A: Micrologic with ammeter
- E: Micrologic "Energy"
- P: Micrologic "Power"

Note: see the description of the Micrologic control units for further details on protection and alarms, measurements, waveform capture, histories, logs and maintenance indicators.

Communication

COM option in ComPact

A

All the ComPact devices can be fitted with the communication function thanks to the COM option. ComPact uses the Ethernet or Modbus communications protocol for full compatibility with the supervision management systems. Eco COM is limited to the transmission of metering data and status. It is not used to communicate controls.

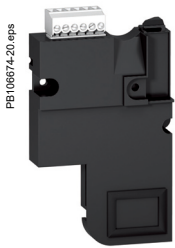

PB10674-20 eps

BCM ULP.



PB119234 eps

I/O application module.

For fixed devices, the COM option is made up of:

- a BCM ULP module, installed behind the Micrologic control unit and supplied with its set of sensors (OF, SDE, PF and CH micro switches) its kit for connection to communicating voltage releases and its COM terminal block (inputs E1 to E6)
- IFM, this module required for connection to the network, contains the Modbus address (1 to 99) declared by the user via the two dials in front. It automatically adapts (baud rate, parity) to the Modbus network in which it is installed.

Or

- IFE, the Ethernet interface for LV circuit breaker enables an intelligent modular unit (IMU), for example a ComPact NS circuit breaker to be connected to an Ethernet network. Each circuit breaker has its own IFE and a corresponding IP address.

For drawout devices, the COM option is made up of:

- a BCM ULP module, installed behind the Micrologic control unit and supplied with its set of sensors (OF, SDE, PF and CH micro switches) its kit for connection to communicating voltage releases and its COM terminal block (inputs E1 to E6)
- IFM, this module required for connection to the network, contains the Modbus address (1 to 99) declared by the user via the two dials in front. It automatically adapts (baud rate, parity) to the Modbus network in which it is installed.

Or

- IFE, the Ethernet interface for LV circuit breaker enables an intelligent modular unit (IMU), for example a ComPact NS circuit breaker to be connected to an Ethernet network. Each circuit breaker has its own IFE and a corresponding IP address.
- I/O (Input/Output) application module for LV breaker, the I/O application module is delivered with withdrawable devices ordered with the COM option, for cradle management. It must be installed on a DIN rail near the device. It must be connected to the ULP system and to the position contacts (CD, CT, CE) that transmit the position of the device in the cradle.

BCM ULP module

This module is independent of the control unit. It receives and transmits information on the communication network. An infra-red link transmits data between the control unit and the communication module.
Consumption: 30 mA, 24 V.

XF and MX1 communicating voltage releases

The XF and MX1 communicating voltage releases are equipped for connection to the “device” communication module.

The remote-tripping function (MX2 or MN) are independent of the communication option. They are not equipped for connection to the “device” communication module.

A

Electrical operated

Fixed device

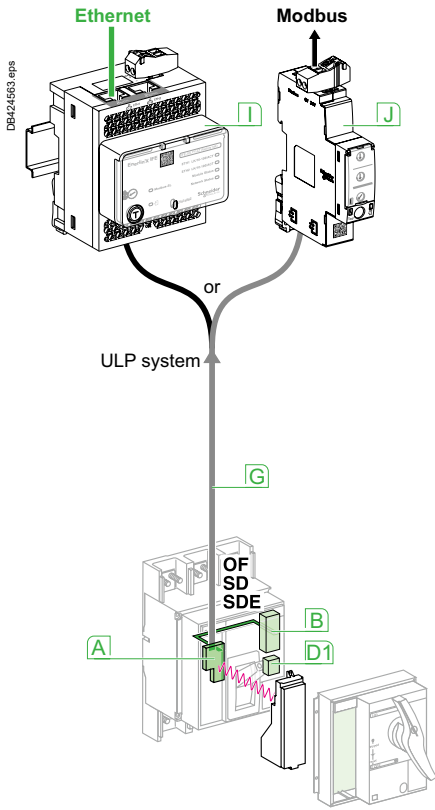

Manually operated fixed device

Drawout devices

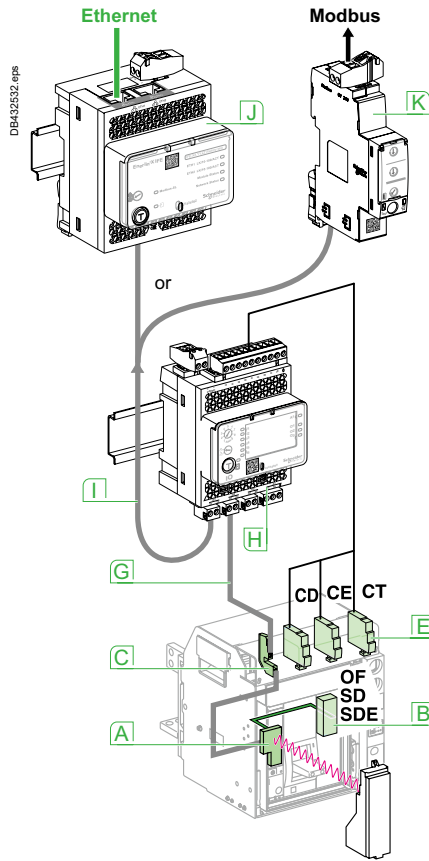

Manually operated withdrawable device

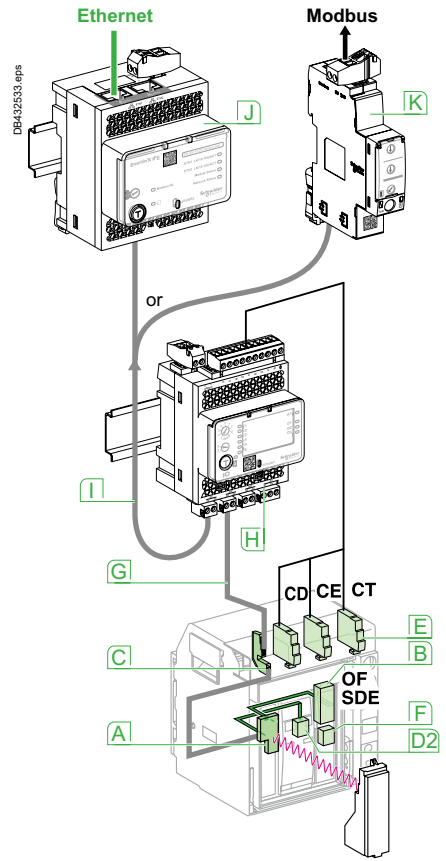

Electrically operated withdrawable device

- A** BCM ULP
- B** OF, SDE ... microswitches
- C** COM terminal block (E1 to E6)
- D1** Manually operated device : no communicating voltage releases or MX or MN (in option)
- D2** Electrically operated device MX or MN (closing release included in motor mechanism)
- E** CE, CD and CT contacts

- F** Motor mechanism (MCH)
- G** Breaker ULP cord
- H** I/O application module
- I** ULP cable
- J** IFE module
- K** IFM module

A



PB119112.eps

IFE interface, ref.: LV434001



PB119113.eps

IFE interface + gateway, ref.: LV434002

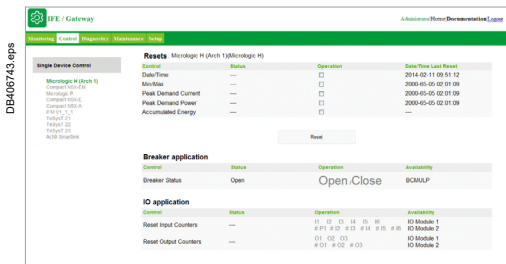

DB406745.eps

IFE interface, IFE interface + gateway description

Introduction

The IFE interface and IFE interface + gateway enable LV circuit breakers as MasterPact, ComPact NSX or PowerPact to be connected to an Ethernet network.

IFE interface: ref. LV434001

Provides an Ethernet access to a single LV circuit breaker.

Function

Interface - one circuit breaker is connected to the IFE interface via its ULP port.

IFE interface + gateway: ref. LV434002

Provides an Ethernet access to one or several LV circuit breakers.

Functions

- Interface - one circuit breaker is connected to the IFE interface via its ULP port.
- Gateway: several circuit breakers on a Modbus network are connected via the IFE interface + gateway master Modbus port.

IFE interface, IFE interface + gateway features

- Dual 10/100 Mbps Ethernet port for simple daisy chain connection.
- Device profile web service for discovery of the IFE interface, IFE interface + gateway on the LAN.
- ULP compliant for localization of the IFE interface in the switchboard.
- Ethernet interface for ComPact, MasterPact and PowerPact circuit breakers.
- Gateway for Modbus-SL connected devices (IFE interface + gateway only).
- Embedded set-up web pages.
- Embedded monitoring web pages.
- Embedded control web pages.
- Built-in e-mail alarm notification.

Mounting

The IFE interface, IFE interface + gateway are DIN rail mounting devices. A stacking accessory enables the user to connect several IFMs (ULP to Modbus interfaces) to an IFE interface + gateway without additional wiring.

24 V DC power supply

The IFE interface, IFE interface + gateway must always be supplied with 24 V DC. The IFMs stacked to an IFE interface + gateway are supplied by the IFE interface + gateway, thus it is not necessary to supply them separately. It is recommended to use an UL listed and recognized limited voltage/limited current or a class 2 power supply with a 24 V DC, 3 A maximum.

IFE interface, IFE interface + gateway firmware update

The firmware can be updated using:

- FTP
- Ecoreach software.

Required circuit breaker communication modules

The connection to IFE interface or IFE interface + gateway requires a communication module embedded into the circuit breaker:

- ComPact NS: BCM ULP communication module.
- Withdrawable ComPact NS: BCM ULP and its respective I/O (Input/Output) application module. All connection configurations for ComPact NS require the breaker ULP cord. The insulated NSX cord is mandatory for system voltages greater than 480 V AC. When the second ULP RJ45 connector is not used, it must be closed with an ULP terminator (TRV00880).

Network communication interface

Characteristic	Value	
Type of interface module	Modbus RTU, RS485 serial connection Modbus TCP/IP Ethernet	
Transmission	Modbus RS485	Transfer rate: 9,600...19,200 Baud Medium Double shielded twisted pair Impedance 120 Ω
	Ethernet	Transfer rate : 10/100 Mbps Medium STP, Cat5e, straight cable
Structure	Type	Modbus, Ethernet
	Method	Master/Slave
Device type	Modbus	Master
	Ethernet	Server
Turnaround time	Modbus	10 ms
	Ethernet	1 ms
Maximum length of cable	Modbus	1000 m
	Ethernet	100 m
Type of bus connector	Modbus	4-pin connector
	Ethernet	RJ45 (Shielded)



General characteristics	
Environmental characteristics	
Conforming to standards	UL 508, UL 60950, IEC 60950, 60947-6-2
Certification	cULUs, GOST, FCC, CE
Ambient temperature	-20 to +70 °C (-4 to +158 °F)
Relative humidity	5–85 %
Level of pollution	Level 3
Flame resistance	ULV0
Mechanical characteristics	
Shock resistance	1000 m/s ²
Resistance to sinusoidal vibrations	-5 Hz < f < 8.4 Hz
Electrical characteristics	
Resistance to electromagnetic discharge	Conforming to IEC/EN 61000-4-3
Immunity to radiated fields	10 V/m
Immunity to surges	Conforming to IEC/EN 61000-4-5
Consumption	120 mA at 24 V input
Physical characteristics	
Dimensions	72 x 105 x 71 mm (2.83 x 4.13 x 2.79 in.)
Mounting	DIN rail
Weight	182.5 g (0.41 lb)
Degree of protection of the installed IO	<ul style="list-style-type: none"> ■ On the front panel (wall mounted enclosure): IP4x ■ Connectors: IP2x ■ Other parts: IP3x
Connections	Screw type terminal blocks
Technical characteristics - 24 V DC power supply	
Power supply type	Regulated switch type
Rated power	72 W
Input voltage	100–120 V AC for single phase 200–500 V AC phase-to-phase
PFC filter	With IEC 61000-3-2
Output voltage	24 V DC
Power supply out current	3 A

Note: it is recommended to use an UL listed/UL listed recognized limited voltage/Limited current or a class 2 power supply with a 24 V DC, 3 A maximum.

IFE web page description	
Monitoring web page	
Real time data 67	<input type="radio"/>
Device logging	<input type="radio"/>
Control web page	
Single device control	<input type="radio"/>
Diagnostics web page	
Statistics	<input type="radio"/>
Device information	<input type="radio"/>
IMU information	<input type="radio"/>
Read device registers	<input type="radio"/>
Communication check	<input type="radio"/>
Maintenance web page	
Maintenance log	<input type="radio"/>
Maintenance counters	<input type="radio"/>
Setup web page	
Device localization/name	<input type="radio"/>
Ethernet configuration (dual port)	<input type="radio"/>
IP configuration	<input type="radio"/>
Modbus TCP/IP filtering	<input type="radio"/>
Serial port	<input type="radio"/>
Date and time	<input type="radio"/>
E-mail server configuration	<input type="radio"/>
Alarms to be e-mailed	<input type="radio"/>
Device list	<input type="radio"/>
Device logging	<input type="radio"/>
Device log export	<input type="radio"/>
SNMP parameters	<input type="radio"/>
Documentation links	<input type="radio"/>
Preferences	<input type="radio"/>
Advanced services control	<input type="radio"/>
User accounts	<input type="radio"/>
Web page access	<input type="radio"/>

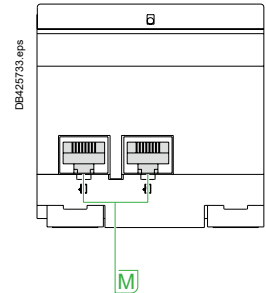
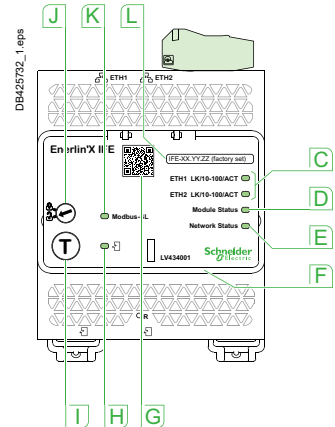
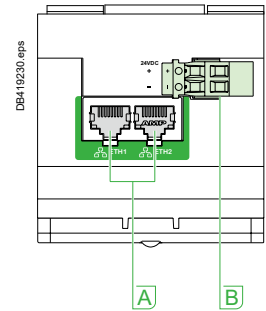

- A** Ethernet 1 and Ethernet 2 communication port.
- B** 24 V DC power supply terminal block.
- C** Ethernet communication LEDs:
yellow: 10 Mb
green: 100 Mb.
- D** Module status LED:
steady off: no power
steady green: device operational
steady red: major fault
flashing green: standby
flashing red: minor fault
flashing green/red: self-test.
- E** Network status LED:
steady off: no power/no valid IP address
steady green: connected, valid IP address
steady orange: default IP address
steady red: duplicated IP address
flashing green/red: self-test.
- F** Sealable transparent cover.
- G** QR code to product information.
- H** ULP status LED.
- I** Test button (with cover closed).
- J** Locking pad.
- K** Modbus traffic status LED (LV434002 only).
- L** Device name label.
- M** ULP ports.

IFM Modbus communication interface

A



PB119111_eps

IFM Modbus communication interface.
Ref.: LV434000.

Function

IFM - Modbus communication interface - is required for connecting MasterPact or ComPact NS and NSX to Modbus network whenever the circuit breaker has an ULP port (Universal Logic Plug). The port is available on BCM ULP for MasterPact range and BSCM module for ComPact range.

Note: IFM is defined as an IMU (Intelligent Modular Unit) in the ULP connection System documentation.

Once connected to IFM, the circuit breaker is considered as a slave by the Modbus master. Its electrical values, alarm status, open/close signals can be monitored or controlled by a Programmable Logic Controller or any other system.

Characteristics

ULP port

2 RJ45 sockets, internal parallel wiring.

- Connection of a single circuit breaker (eventually via its I/O application module).
- An ULP line terminator or FDM121 display unit must be connected to the second RJ45 ULP socket.

The RJ45 sockets deliver a 24 V DC supply fed from the Modbus socket. Built-in test function, for checking the correct connection to the circuit breaker and FDM121 display unit.

Modbus slave port

- Modbus SL RJ45 port - RJ45 connector ensures fast and reliable wiring.
- Lateral socket, for Din-rail stackable connector.

Both top and lateral sockets are internally parallel wired.

- Multiple IFM can be stacked, thus sharing a common power supply and Modbus line without individual wiring.

■ On the front face:

- Modbus address setting (1 to 99): 2 coded rotary switches
- Modbus locking pad: enables or disable the circuit breaker remote control and modification of IFM parameters.
- Self adjusting communication format (Baud rate, parity).

24 V DC power supply

- Screw clamp terminal block
- High electrical insulation between Modbus and 24 V DC connectors + separated lines ensure improved communication robustness.

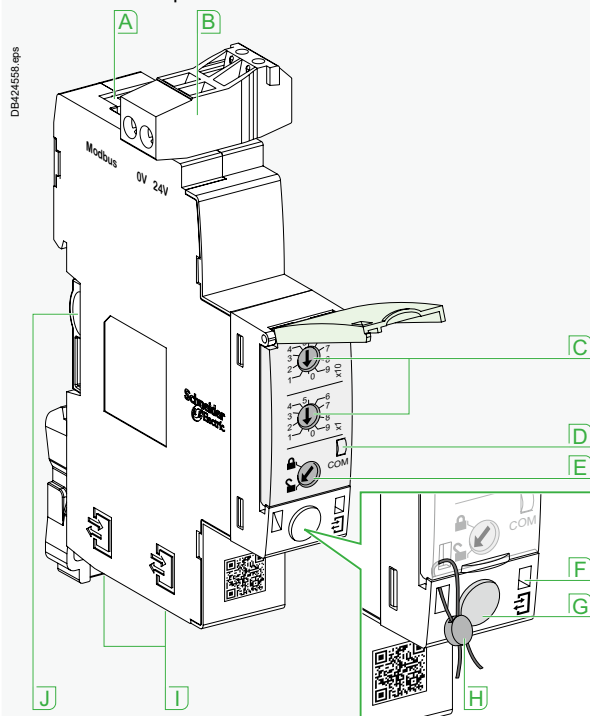

- A** Modbus SL RJ45 port.
- B** 0-24 V DC power supply
- C** Modbus address switches.
- D** Modbus traffic LED.
- E** Modbus locking pad.
- F** ULP activity LED.
- G** Test button.
- H** Mechanical lock.
- I** ULP RJ45 connectors.
- J** Stacking accessory connection.

IFM Modbus communication interface



Technical characteristics

IFM Modbus communication interface

Dimensions		18 x 73 x 90 mm
Maximum number of stacked IFM		12
Degree of protection of the installed module	Part projecting beyond the escutcheon	IP4x
	Other module parts	IP3x
	Connectors	IP2x
Operating temperature		-25...+70 °C
Power supply voltage		24 V DC -20 %/+10 % (19.2...26.4 V DC)
Consumption	Typical	21 mA/24 V DC at 20 °C
	Maximum	30 mA/19.2 V DC at 60 °C

Certification

CE	IEC/EN 60947-1
UL	UL 508 - Industrial Control Equipment
CSA	No. 142-M1987 - Process Control Equipment
	■ CAN/CSA C22.2 No. 0-M91 - General requirements - Canadian Electrical Code Part
	■ CAN/CSA C22.2 No. 14-05 - Industrial Control Equipment

Recommended IFM installation

Staking IFM

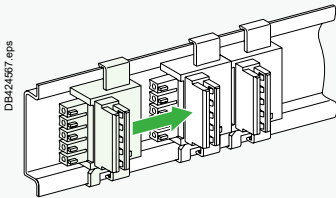

Stacking accessories

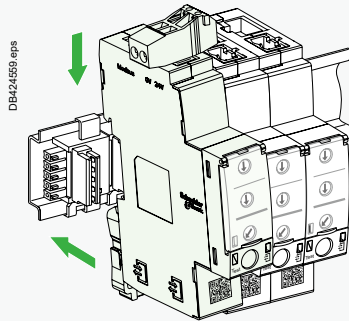

Up to 12 stacked IFM

Stacking an IFE interface + gateway with IFM

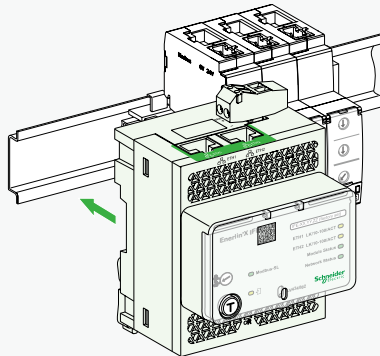
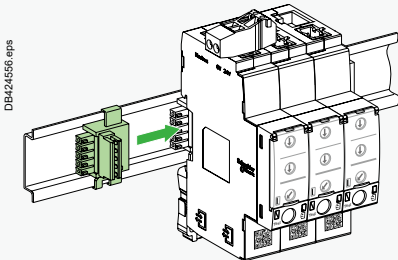

Connection of the IFE to a fixed or drawout ComPact NS

A

Connect the IFE to a fixed manual operated ComPact NS or circuit breaker using the breaker ULP cord

Connect the IFE to a drawout ComPact NS or circuit breaker using the breaker ULP cord

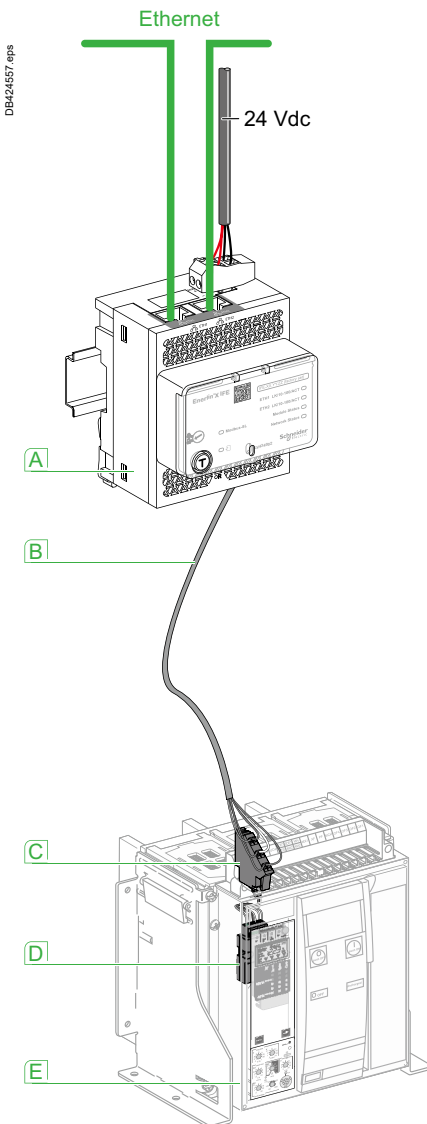

- A** IFE Ethernet interface for LV circuit breaker
- B** Breaker ULP cord
- C** Fixed terminal block
- D** BCM ULP communication module
- E** Fixed electrically operated circuit breaker

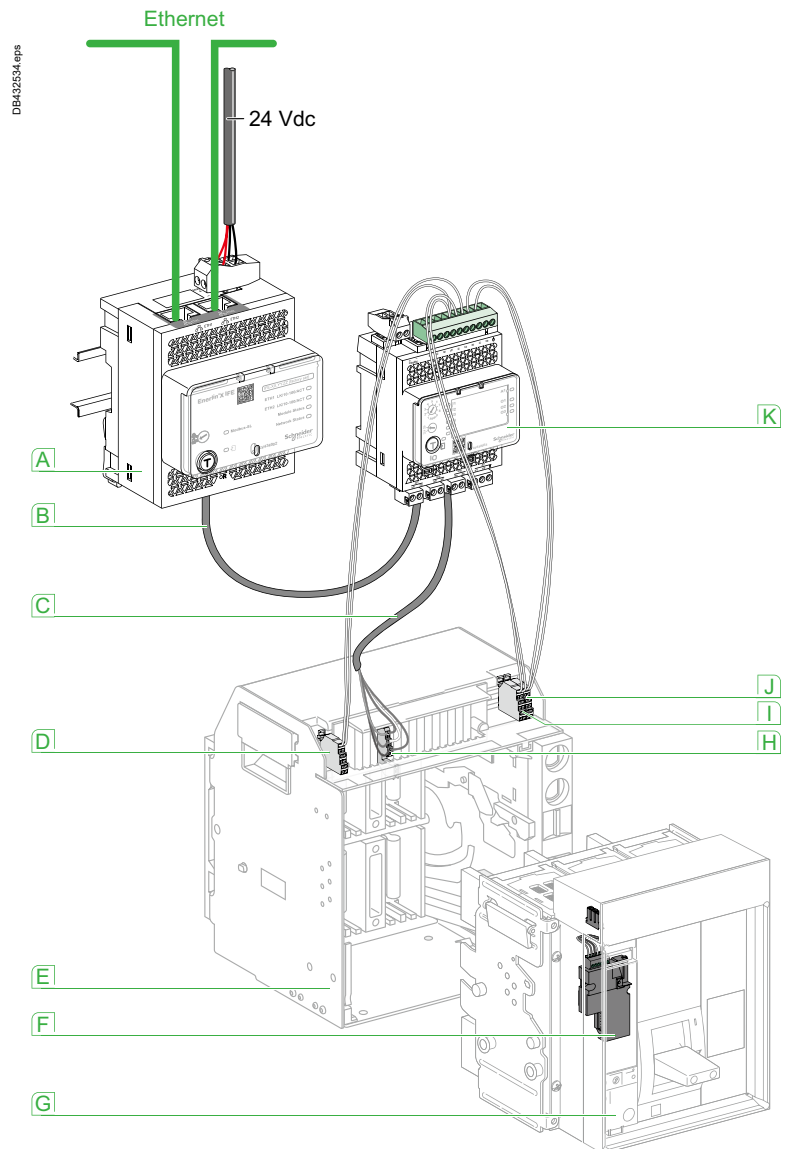

- A** IFE Ethernet interface for LV circuit breaker
- B** ULP cable
- C** Breaker ULP cord
- D** Circuit breaker disconnected position contact (CD)
- E** Circuit breaker cradle
- F** BCM ULP communication module
- G** Drawout circuit breaker
- H** Drawout terminal block
- I** Circuit breaker connected position contact (CE)
- J** Circuit breaker test position contact (CT)
- K** I/O (Input/Output) application module for LV circuit breaker

Connection of the IFM to a fixed or drawout ComPact NS

Modbus interface module IFM

Functions

This module, required for connection to the network, contains the Modbus address (1 to 99) declared by the user via the two dials in front. It automatically adapts (baud rate, parity) to the Modbus network in which it is installed.

It is equipped with a lock-out switch to enable or disable operations involving writing to Micrologic, i.e. reset, counter reset, setting modifications, device opening and closing commands, etc.

There is a built-in test function to check the connections of the Modbus interface module with the Micrologic and FDM121 display unit.

Mounting

The module is mounted on a DIN rail. A number of modules may be clipped one next to the other. For this, a stacking accessory is available for fast clip-connection of both the Modbus link and the 24 V DC supply.

The Modbus interface module supplies 24 V DC to the corresponding Micrologic, FDM121 display and BSCM module. Module consumption is 60 mA / 24 V DC.

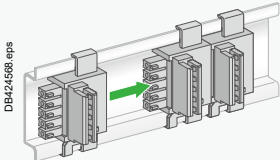

Mounting with stacking accessory.

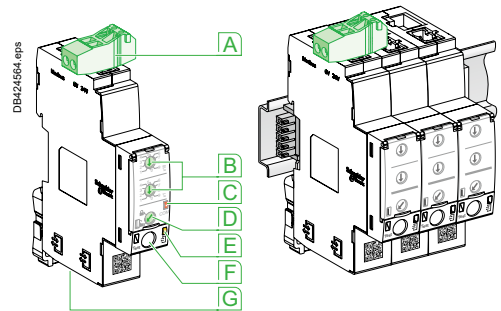

- A** Five-point Modbus and 24 V DC connector
- B** Two Modbus address dials (1 to 99)
- C** Modbus traffic LED
- D** Lock-out to disable writing to the NSX
- E** Test LED
- F** Test button
- G** Two connectors for RJ45 cable



Connect the IFM to a fixed manual operated ComPact NS or circuit breaker using the breaker ULP cord

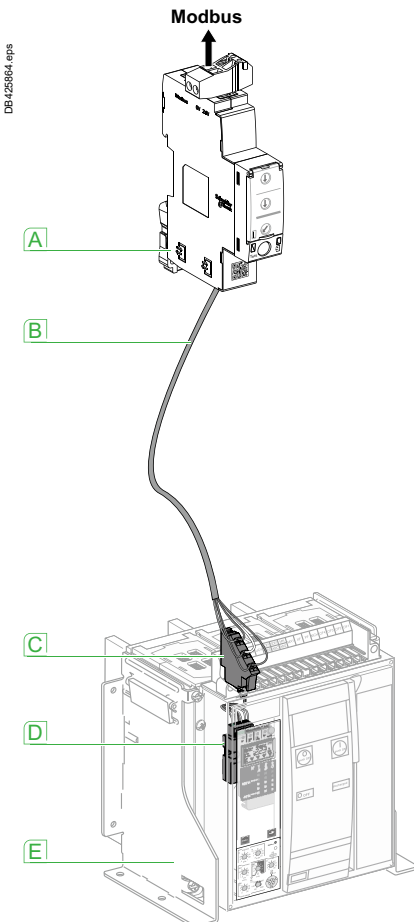

- A** IFM Ethernet interface for LV circuit breaker
- B** Breaker ULP cord
- C** Fixed terminal block
- D** BCM ULP communication module
- E** Fixed electrically operated circuit breaker

Connect the IFM to a drawout ComPact NS or circuit breaker using the breaker ULP cord

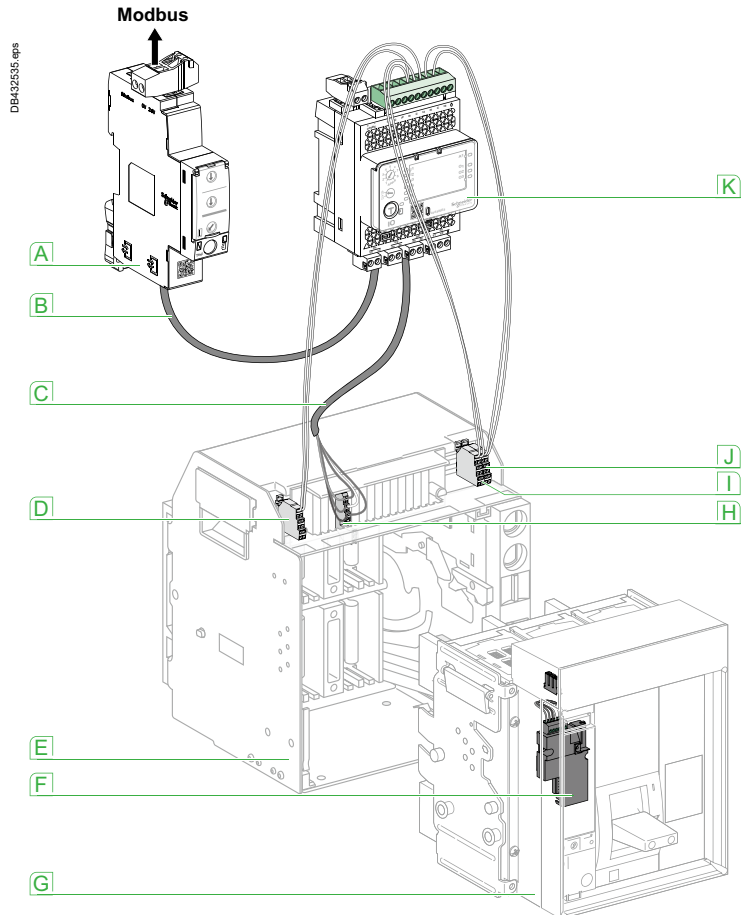

- A** IFM Ethernet interface for LV circuit breaker
- B** ULP cable
- C** Breaker ULP cord
- D** Circuit breaker disconnected position contact (CD)
- E** Circuit breaker cradle
- F** BCM ULP communication module
- G** Drawout circuit breaker
- H** Drawout terminal block
- I** Circuit breaker connected position contact (CE)
- J** Circuit breaker test position contact (CT)
- K** I/O (Input/Output) application module for LV circuit breaker

A



I/O application module

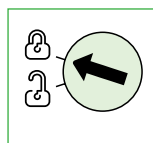
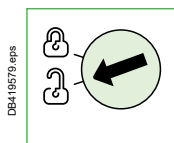
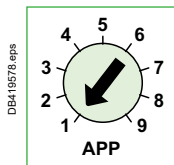

I/O application module description

Description

The I/O (Input/Output) application module for LV breaker is part of an ULP system with built-in functionalities and applications to enhance the application needs. The ULP system architecture can be built without any restrictions using the wide range of circuit breakers.

The I/O application module is compliant with the ULP system specifications. Two I/O application module can be connected in the same ULP network.

The ranges of LV circuit breakers enhanced by the I/O application module are:

- MasterPact
- ComPact NS1600b-3200
- ComPact NS630b-1600
- ComPact NSX100-630 A.

I/O (Input/Output) application module for LV breaker resources

The I/O application module resources are:

- 6 digital inputs that are self powered for either NO and NC dry contact or pulse counter
- 3 digital outputs that are bistable relay (5 A maximum)
- 1 analog input for Pt100 temperature sensor.

Pre-defined applications

Pre-defined application adds new functions to the IMU in a simple way:

- selection by the application rotary switch on the I/O application module, defining the application with pre-defined input/output assignment and wiring diagram.
- no additional setting with the Ecoreach software required.

The resources not assigned to the pre-defined application are free for additional user-defined applications:

- cradle management
- breaker operation
- light and load control
- custom.

User-defined applications

User-defined applications are processed by the I/O application module in addition to the pre-defined application selected.

The user-defined applications are available depending on:

- the pre-defined application selected
- the I/O application module resources (inputs and outputs) not used by the application.

The resources required by user-defined applications are assigned using the Ecoreach software:

- protection
- control
- energy management
- monitoring.

Mounting

The I/O application module is a DIN rail mounting device.

Application rotary switch

The application rotary switch enables the selection of the pre-defined application.

It has 9 positions and each position is assigned to a pre-defined application.

The factory set position of the switch is pre-defined application 1.

Setting locking pad

The setting locking pad on the front panel of the I/O application module enables the setting of the I/O application module by the Ecoreach software.

General characteristics

Environmental characteristics

Conforming to standards	UL 508, UL 60950, IED 60950, 60947-6-2
Certification	cUIUs, GOST, FCC, CE
Ambient temperature	-20 to +70 °C (-4 to +158 °F)
Relative humidity	5–85 %
Level of pollution	Level 3
Flame resistance	ULV0

Mechanical characteristics

Shock resistance	1000 m/s ²
Resistance to sinusoidal vibrations	-5 Hz < f < 8.4 Hz

Electrical characteristics

Resistance to electromagnetic discharge	Conforming to IEC/EN 61000-4-3
Immunity to radiated fields	10 V/m
Immunity to surges	Conforming to IEC/EN 61000-4-5
Consumption	165 mA

Physical characteristics

Dimensions	71.7 x 116 x 70.6 mm (2.83 x 4.56 x 2.78 in.)
Mounting	DIN rail
Weight	229.5 g (0.51 lb)
Degree of protection of the installed I/O application module	On the front panel (wall mounted enclosure): IP4x IO parts: IP3x Connectors: IP2x
Connections	Screw type terminal blocks

Technical characteristics - 24 V DC power supply

Power supply type	Regulated switch type
Rated power	72 W
Input voltage	100–120 V AC for single phase 200–500 V AC phase-to-phase
PFC filter	With IEC 61000-3-2
Output voltage	24 V DC
Power supply out current	3 A

Note: it is recommended to use an UL listed/UL listed recognized limited voltage/Limited current or a class 2 power supply with a 24 V DC, 3 A maximum.

Digital inputs

Digital input type	Self powered digital input with current limitations as per IEC 61131-2 type 2 standards (7 mA)
Input limit values at state 1 (close)	19.8–25.2 V DC, 6.1–8.8 mA
Input limit values at state 0 (open)	0–19.8 V DC, 0 mA
Maximum cable length	10 m (33 ft)

Note: for a length greater than 10 m (33 ft) and up to 300 m (1,000 ft), it is mandatory to use a shielded twisted cable. The shield cable is connected to the I/O functional ground of the I/O application module.

Digital outputs

Digital output type	Bistable relay
Rated load	5 A at 250 V AC
Rated carry current	5 A
Maximum switching voltage	380 V AC, 125 V DC
Maximum switch current	5 A
Maximum switching power	1250 VA, 150 W
Minimum permissible load	10 mA at 5 V DC
Contact resistance	30 mΩ
Maximum operating frequency	18000 operations/hr (Mechanical) 1800 operations/hr (Electrical)
Digital output relay protection by an external fuse	External fuse of 5 A or less
Maximum cable length	10 m (33 ft)

Analog inputs

The I/O application module analog input can be connected to a Pt100 temperature sensor

Range	-30 to 200 °C	-22 to 392 °F
Accuracy	±2 °C from -30 to 20 °C ±1 °C from 20 to 140 °C ±2 °C from 140 to 200 °C	±3.6 °F from -22 to 68 °F ±1.8 °F from 68 to 284 °F ±3.6 °F from 284 to 392 °F
Refresh interval	5 s	5 s

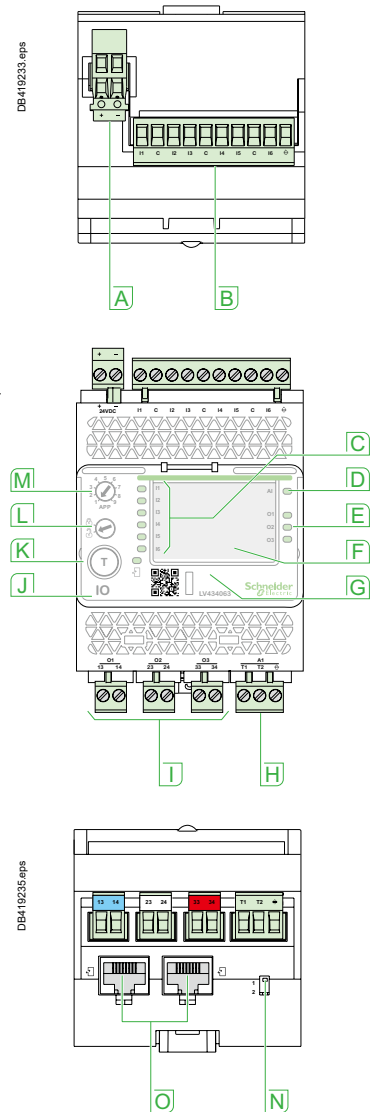

- A** 24 V DC power supply terminal block.
- B** Digital input terminal block: 6 inputs, 3 commons and 1 shield.
- C** 6 input status LEDs.
- D** Analog input status LED.
- E** 3 output status LEDs.
- F** I/O application module identification labels.
- G** Sealable transparent cover.
- H** Analog input terminal block.
- I** Digital output terminal blocks.
- J** ULP status LED.
- K** Test/reset button (accessible with cover closed).
- L** Setting locking pad.
- M** Application rotary switch: 1 to 9.
- N** Switch for I/O addressing (I/O 1 or I/O 2).
- O** ULP connectors.

[1] 250 V AC OVC 2 according IEC/EN 60947-2. For OVC 3 and 4 surge arresters are required on the polarizing voltage of the output contacts.

Electrical Asset Manager Configuration Engineering tool

A

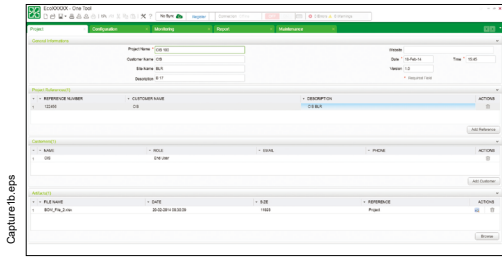

Capture1b.eps

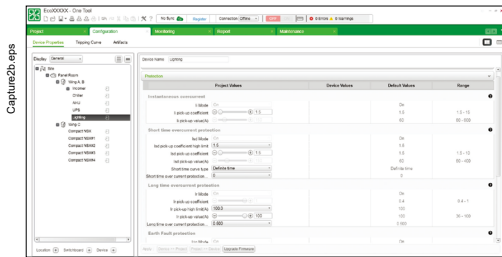

Capture2b.eps

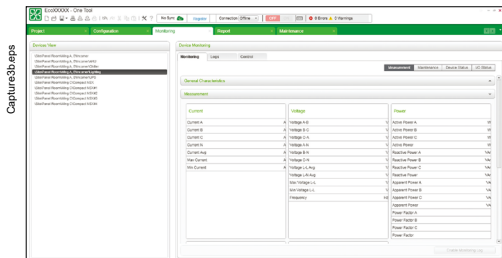

Capture3b.eps

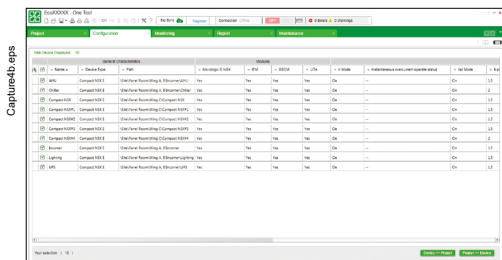

Capture4b.eps

Introduction

Electrical Asset Manager is a software application that helps the user to manage a project as part of designing, testing, site commissioning, and maintenance of the project life cycle.

It enables the user to prepare the settings of the devices offline (without connecting to the device) and configure them when connected with the devices.

Also it provides lot of other value added features for the user to manage the project such as, safe repository in cloud, attach artifacts to each device or at the project level, organize devices in switchboard wise, manage a hierarchical structure of the installation etc.

Compatible devices (configuration and device management)

Electrical Asset Manager is compatible with the following devices:

- Compact NSX100-630 (IEC)
- PowerPact™ (UL) circuit breaker
- Compact NS630b-3200 (IEC)
- MasterPact (IEC and UL) circuit breaker
- Acti9 Smartlink.
- Compatible devices (Device Management in the project)
- Switch disconnectors (Compact NSX, MasterPact & PowerPact Family)
- Third party devices.

References:

Electrical Asset Manager software package can be downloaded from our website www.schneider-electric.com.

Features

Electrical Asset Manager supersedes the Schneider Electric customer engineering tools such as Remote setting Utility (RSU) and Remote Control Utility (RCU) with additional features.

Electrical Asset Manager supports the connection of Schneider Electric communicable devices to:

- create projects by device discovery, selection of devices, and import Bill of Material (BOM)
- monitor the status of protection and I/O status
- read information (alarms, measurements, parameters)
- check protection selectivity between two devices
- upload and download of configuration or settings in batch mode to multiple devices.
- carry out commands and tests
- generate and print device settings report and communication test report
- manage multiple devices with electrical and communication hierarchy model
- manage artifacts (project documents)
- check consistency in settings between devices on a communication network
- compare configuration settings between PC and device (online)
- download latest firmware.

Electrical Asset Manager enables the user to avail the advanced features of the software once the project is saved in Schneider Electric cloud.

Electrical Asset Manager Configuration Engineering tool

Functions

Offline Mode

A project can be built in offline mode through 2 different ways:

- through BOM file import
- through Device Selection.

Additionally, the user can open an existing project and modify the settings offline. The user can do the selectivity curve check and firmware compatibility check for devices in the project.

Online Mode

A project can be built in online mode through device discovery also other than the methods possible through offline method.

Once the project is built, the following functions can be performed in addition to the functions available in offline mode:

- compare the device parameters with project parameters
- load parameters from project to the device and vice versa
- firmware downloads to the device
- monitor the measurement, maintenance, device status and I/O status
- control functions.

User Interface

Electrical Asset Manager software provides fast direct access to the project and the devices in the project through different tabs.

- **Project:** to provide the project information including customer details, project references and to add project artifacts (documents related to the project).
- **Configuration:** to build up the tree structure of the project architecture ; to have a table view of the devices added in the project ; to set the parameters of the devices ; to transfer the device settings ; to view the tripping curves; to attach device artifacts and to download the latest firmware, to do the communication test for all the devices and generate the test report.
- **Monitoring:** this allows the user to monitor the real time values of different devices through different sub tabs namely Monitoring, Logs and Control.
- **Reports:** report tab allows you to generate and print a report of the project settings from the report tab. The user details and project characteristics are automatically filled with the details entered in the Project page.

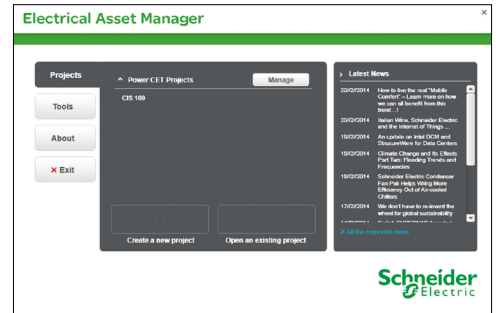

Capture8.eps

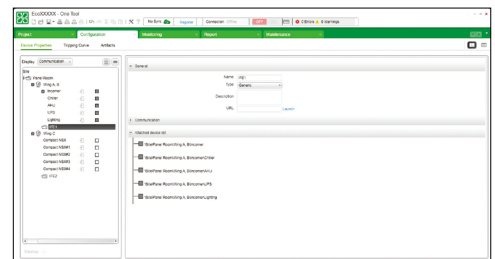

Capture8.eps

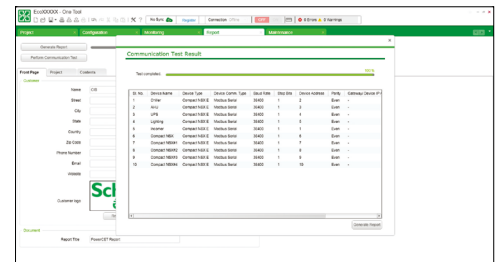

Capture78.eps

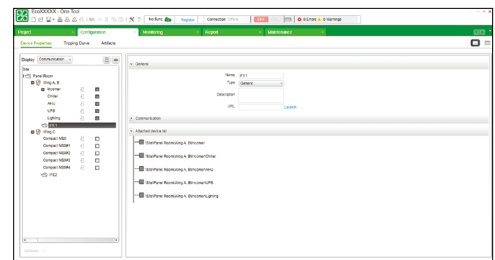

Capture88.eps

Motor protection

Overview of solutions

A

The circuit breakers presented here provide protection against short circuits and are suitable for isolation as defined by standard IEC 60947-2. For complete protection of the motor and its control device, overload protection may be provided by either the circuit breaker or a separate Schneider Electric thermal relay. The control device may be of the direct on-line type (with or without reversing) or of the “star-delta” type. Combinations are governed by standard IEC 60947-4.1.

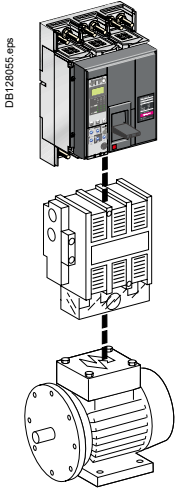

Motor protection up to 750 kW

Motor rating (kW) 160...750

ComPact NS630b to 1600



Breaking capacity (kArms)	N	50
	H	70
	L	150
	380/415 V	

General circuit breaker characteristics page A-12

ComPact NS630b to 1600 circuit breakers equipped with Micrologic control units are the same as those for distribution systems.

Accompanying control units page A-20

Micrologic electronic control units may be used on all ComPact NS630b to 1600 circuit breakers. Micrologic 2.0 A and 5.0 A electronic control units provide protection against short-circuits and overloads. Micrologic 7.0 A provides the same protection functions, plus earth-leakage protection.

Protection coordination (as defined by IEC 60947-4)

Whatever the power of the motor, the coordination between the circuit breaker, contactor and relay can be of either type 1 or 2.

Selection depends on operational requirements concerning continuity of service and the technical skills of servicing personnel.

All type 2 have been tested under the conditions defined by standards and they are certified ASEFA/LOVAG.

Selection of a trip unit or Micrologic control unit

P (kW) (400 V, 50 Hz)	0.37	1.1	5.5	18.5	37					110	160	250		560	750
I _r (A)	1.5	2.5	12	40	50	80	100	160	200	220	320	500	800	1000	1350
Compact NS630b ... NS1600													Micrologic 2.0 A / 5.0 A / 6.0 A / 7.0 A		
													Micrologic 2.0 E / 5.0 E / 6.0 E		

Earth-leakage protection is obtained by:

- installing a Micrologic 7.0 A control unit (ComCompact NS630b to 3200).
- using a Vigirex relay and separate sensors (all ComCompact circuit breakers).

Circuit breakers equipped with a control unit offering integrated earth-leakage protection and an external rectangular sensor

Rated current (A)

630...1600

ComCompact NS630b to 1000 N/L
NS1250 and 1600 N



1600...3200

ComCompact NS1600b to 3200



General circuit breaker characteristics

[page A-12](#)

ComCompact NS630b to 3200 circuit breakers are presented in the "Protection of distribution systems" section.

Accompanying control units

[page A-22](#)

Micrologic 7.0 A electronic control units offer earth-leakage protection as standard.

Earth-leakage protection using a Vigirex relay

Earth-leakage relay

Separate toroids

Rectangular sensors



ComCompact circuit breaker + Vigirex relay combination

Vigirex relays may be used to add external earth-leakage protection to ComCompact NS circuit breakers. The circuit breakers must be equipped with an MN or MX voltage release. Vigirex relays are very useful when special time-delay or tripping-threshold values are required, or when there are major installation constraints (circuit breaker already installed and connected, limited space available, etc.).

Vigirex-relay characteristics:

- rectangular sensors up to 3200 A
- 50/60/400 Hz distribution systems.

Options:

- trip alarm by a fail-safe contact
- pre-alarm LED and contact, etc.

Compliance with standards:

- IEC 60947-2, annex M
- IEC/EN 60755: general requirements for residual current operated protective devices
- IEC/EN 6100-4-2 to 4-6: immunity tests
- CISPR11: radio-frequency radiated and conducted emission tests
- UL1053 and CSA22.2 No. 144 for RH10, RH21 and RH99 relays at supply voltages up to and including 220/240 V.

Control and isolation

Overview of solutions

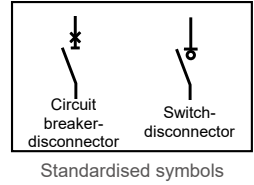

A

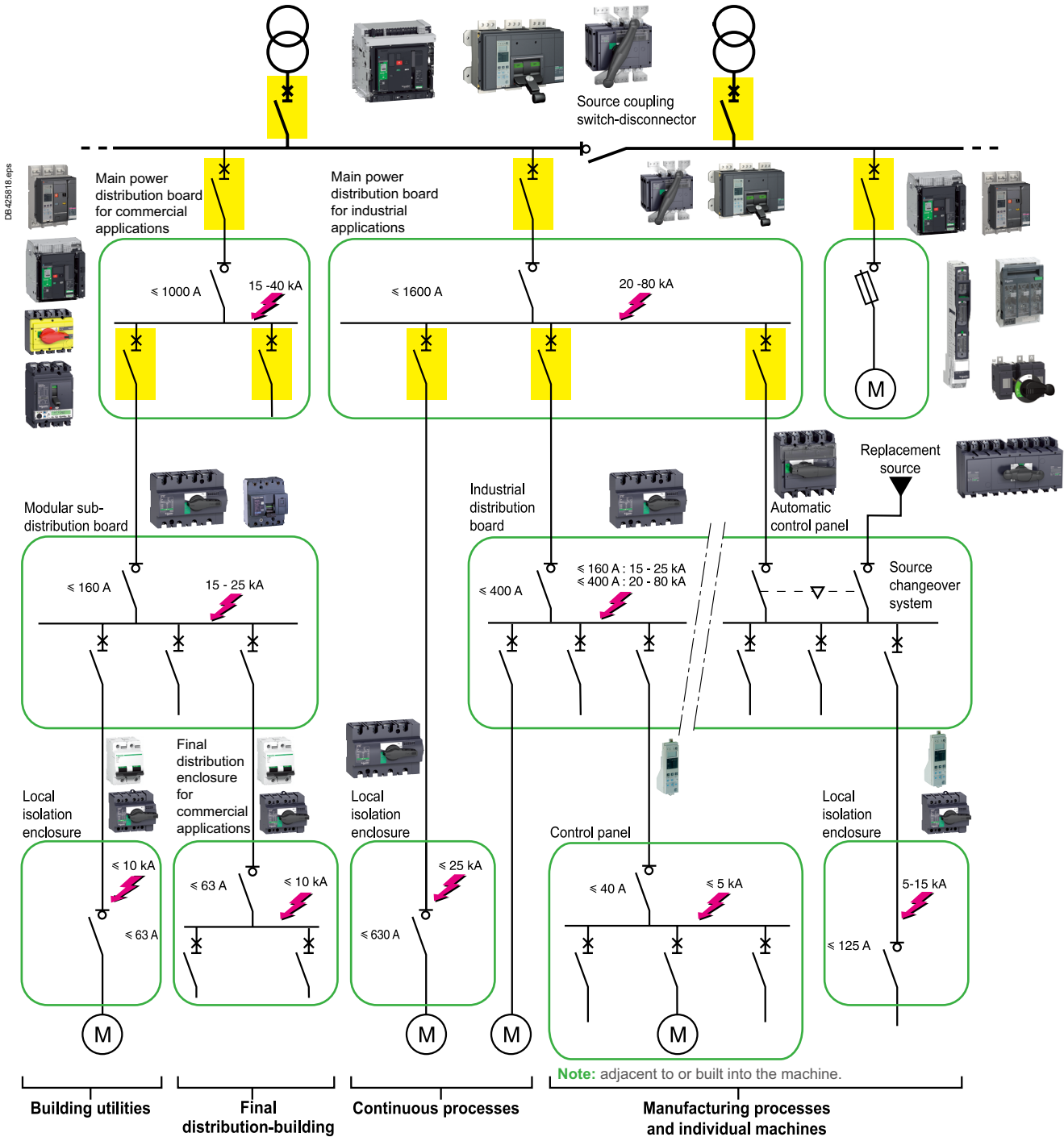

LV devices





ComPact switch-disconnectors are used to control and isolate electrical distribution circuits. In addition to these basic functions, other functions for safety, remote control and convenience include:

- earth-leakage protection
- auxiliary MN/MX releases
- remote operation.

ComPact switch-disconnectors may be interlocked with another ComPact switch-disconnector or circuit breaker to constitute a source-changeover system.



ComPact NS1600NA manual switch-disconnector.



ComPact NS1600NA electrical switch-disconnector.

Control and disconnection

ComPact NS630bNA to 1600NA switch-disconnectors

Installation standards require upstream protection.

A



ComPact NS1600NA manual switch-disconnector.



ComPact NS1600NA electrical switch-disconnector.

ComPact switch-disconnectors

Number of poles		
Control	manual	toggle
		direct or extended rotary handle
Connections	electric	front connection
		rear connection
	withdrawable (on chassis)	front connection
		rear connection

Electrical characteristics as per IEC 60947-3 and EN 60947-3

Conventional thermal current (A)	I_{th}	60 °C		
Rated insulation voltage (V)	U_i			
Rated impulse withstand voltage (kV)	U_{imp}			
Rated operational voltage (V)	U_e	AC 50/60 Hz		
Rated operational current	I_e	220/240 V		
		380/415 V		
		440/480 V		
		500/525 V		
		660/690 V		
Short-circuit making capacity	I_{cm}	(kA peak)		
Short-time withstand current	I_{cw}	(kA rms)	0.5 s	
			20 s	
Suitability for isolation				
Durability (C-O cycles)	mechanical			
	electrical	AC	440 V	AC23A/In
Positive contact indication				
Pollution degree				

Protection

Add-on earth-leakage protection combination with Vigirex relay

Additional indication and control auxiliaries

Indication contacts		
Voltage releases	MX shunt release	
	MN undervoltage release	

Remote communication by bus

Device status indications (communicating auxiliary contacts)

Device remote operation (communicating motor mechanism)

Installation

Accessories	terminal extensions and spreaders	
	terminal shields and interphase barriers	
	escutcheons	
Dimensions (mm)	fixed	3P
W x H x D		4P
Weight (kg)	fixed	3P
		4P

Source-changeover system (see section "on source-changeover systems")

Manual source-changeover systems, remote-operated and automatic

Control and disconnection

ComPact NS630bNA to 1600NA switch-disconnectors

A

NS630bNA	NS800NA	NS1000NA	NS1250NA	NS1600NA
3, 4	3, 4	3, 4	3, 4	3, 4
⊙	⊙	⊙	⊙	⊙
⊙	⊙	⊙	⊙	⊙
⊙	⊙	⊙	⊙	⊙
⊙	⊙	⊙	⊙	⊙
⊙	⊙	⊙	⊙	⊙
⊙	⊙	⊙	⊙	⊙
⊙	⊙	⊙	⊙	⊙
630	800	1000	1250	1600
1000	1000	1000	1000	1000
8	8	8	8	8
690	690	690	690	690
AC23A	AC23A	AC23A	AC23A	AC23A
630	800	1000	1250	1600
630	800	1000	1250	1600
630	800	1000	1250	1600
630	800	1000	1250	1600
630	800	1000	1250	1600
52	52	52	52	52
25	25	25	25	25
4	4	4	4	4
⊙	⊙	⊙	⊙	⊙
10000	10000	10000	10000	10000
2000	2000	2000	2000	1000
⊙	⊙	⊙	⊙	⊙
3	3	3	3	3
⊙				
⊙				
⊙				
⊙				
⊙				
⊙				
⊙				
⊙				
327 x 210 x 147				
327 x 280 x 147				
14				
18				
⊙				

Control and disconnection

ComPact NS1600bNA to 3200NA switch-disconnectors

A

Installation standards require upstream protection. However, ComPact NS1600b to 3200NA switch-disconnectors are self-protected for all currents higher than 130 kA peak.

PE 104838.eps

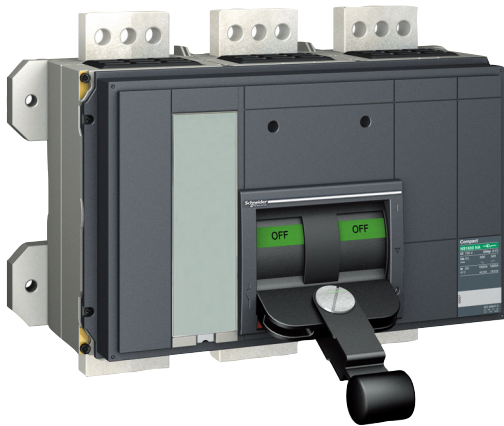

ComPact NS2000NA.

ComPact switch-disconnectors

Number of poles			
Control	manual	toggle	
		direct or extended rotary handle	
Connections	electric	fixed	front connection
			rear connection
	withdrawable (on chassis)	fixed	front connection
			rear connection

Electrical characteristics as per IEC 60947-3 and EN 60947-3

Conventional thermal current (A)	I_{th}	60 °C		
Rated insulation voltage (V)	U_i			
Rated impulse withstand voltage (kV)	U_{imp}			
Rated operational voltage (V)	U_e	AC 50/60 Hz		
Rated operational current	I_e	AC 50/60 Hz		
		220/240 V		
		380/415 V		
		440/480 V		
		500/525 V		
		660/690 V		
Short-circuit making capacity	I_{cm}	(kA peak)		
Short-time withstand current	I_{cw}	(kA rms)	3 s	
Integrated instantaneous protection (kA peak ±10 %)				
Suitability for isolation				
Durability (C-O cycles)	mechanical			
	electrical	AC	440 V	AC23A/In

Positive contact indication

Pollution degree

Protection

Add-on earth-leakage protection combination with Vigirex relay

Additional indication and control auxiliaries

Indication contacts

Voltage releases	MX shunt release
	MN undervoltage release

Installation

Accessories	escutcheons		
Dimensions (mm)	fixed	3P	
		4P	
W x H x D		3P	
Weight (kg)	fixed	3P	
		4P	

Source-changeover system (see section "on source-changeover systems")

Manual source-changeover systems, remote-operated and automatic

Control and disconnection

ComPact NS1600bNA to 3200NA switch-disconnectors



NS1600bNA	NS2000NA	NS2500NA	NS3200NA
3, 4	3, 4	3, 4	3, 4
⊙	⊙	⊙	⊙
-	-	-	-
-	-	-	-
⊙	⊙	⊙	⊙
-	-	-	-
-	-	-	-
-	-	-	-
1600	2000	2500	3200
800	800	800	800
8	8	8	8
690	690	690	690
AC23A	AC23A	AC23A	AC23A
1600	2000	2500	3200
1600	2000	2500	3200
1600	2000	2500	3200
1600	2000	2500	3200
1600	2000	2500	3200
135	135	135	135
32	32	32	32
130	130	130	130
⊙	⊙	⊙	⊙
6000	6000	6000	6000
1000	1000	1000	1000
⊙	⊙	⊙	⊙
3	3	3	3
⊙			
⊙			
⊙			
⊙			
⊙			
350 x 420 x 160			
350 x 535 x 160			
23			
36			
-			

Source-changeover systems Presentation

A

PB191613-50_eps



65837-117_eps



P109832-104_eps



Some installations use two supply sources to counter the temporary loss of the main supply.

A source-changeover system is required to safely switch between the two sources. The replacement source can be a generator set or another network.

Manual source-changeover system or MTSE (Manual Transfer Switching Equipment)

The simplest way to switch the load. It is controlled manually by an operator. The time required to switch from the S1 source to S2 source is variable.

System

2 or 3 mechanically interlocked circuit breakers or 2 switch-disconnectors.

Applications

Small commercial buildings and small and medium industrial activities where the need for continuity of service is significant but not a priority.

Automatic source-changeover system or ATSE (Automatic Transfer Switching Equipment)

An automatic controller may be added to a remote operated source-changeover system. It is possible to automatically control source transfer according to programmed (dedicated controllers) or programmable (PLC) operating modes. These solutions ensure optimum energy management.

The time required to switch from the S1 source to S2 source is fixed.

System

2 or 3 circuit breakers linked by an electrical interlocking system. A mechanical interlocking system protects also against incorrect manual operations, with an automatic control system (dedicated controllers).

Applications

Large infrastructures, industry, critical buildings & process where the continuity of service is a priority.

Remote source-changeover system or RTSE (Remote Transfer Switching Equipment)

In this case, no direct human intervention is required. The time required to switch from the S1 source to S2 source is fixed.

System

2 or 3 circuit breakers linked by an electrical interlocking system. A mechanical interlocking system protects also against incorrect manual operations. In this case is necessary to add a PLC controller not dedicated for source-changeover application.

Applications

Industry & Infrastructure where continuity of service requirements are meaningful but not a priority.

Source-changeover systems

Manual source-changeover systems



A manual source-changeover system can be installed on two to three manually-operated circuit breakers or switch-disconnectors. Interlocking is mechanical. Interlocks prevent connection to both sources at the same time, even momentarily.

Interlocking of two devices with rotary handles

The rotary handles are padlocked with the devices in the OFF position. The mechanism inhibits the two devices being closed at the same time, but does allow for both to be open (OFF) at the same time.

Combinations of "Normal" and "Replacement" devices

All ComPact NS630b to 1600 circuit breakers and switch-disconnectors with rotary handles can be interlocked.

Interlocking of a ComPact NS630b with a ComPact NS630b to 1600 is not possible.

Interlocking of a number of devices using keylocks (captive keys)

Interlocking uses two identical keylocks with a single key. This solution enables interlocking between two devices that are physically distant or that have significantly different characteristics, for example between a low and a medium-voltage device, or between ComPact NS circuit breakers and switch-disconnectors. A system of wall-mounted units with captive keys makes possible a large number of combinations between many devices.

Combinations of Normal and Replacement devices

All ComPact NS630b to 1600 circuit breakers and switch-disconnectors with rotary handles or motor mechanisms can be interlocked.

Interlocking of two ComPact NS630b to 1600 devices using connecting rods

The two devices must be mounted one above the other (either 2 fixed or 2 withdrawable/drawout devices).

Installation

This function requires:

- an adaptation fixture on the right side of each circuit breaker or switch-disconnector
- a set of connecting rods with no-slip adjustments.

The adaptation fixtures, connecting rods and circuit breakers or switch-disconnectors are supplied separately, ready for assembly by the customer. The maximum vertical distance between the fixing planes is 900 mm.

Possible combinations of "S1" and "S2" source circuit breakers

Combinaison are possible between ComPact devices and between ComPact NS devices with MasterPact MTZ devices.

Interlocking of two ComPact NS630b to 1600 devices using cables

For cable interlocking, the circuit breakers may be mounted one above the other or side-by-side.

The interlocked devices may be fixed or drawout, three-pole or four-pole, and have different ratings and sizes.

Installation

This function requires:

- an adaptation fixture on the right side of each device
- a set of cables with no-slip adjustments.

The maximum distance between the fixing planes (vertical or horizontal) is 2000 mm.

Possible combinations of "S1" and "S2" source circuit breakers

Source "S1"	Source "S2"			
	NS630b to NS1600	NT06 to NT16	NW08 to NW40	NW40b to NW63
NS630b to NS1600	●	●	●	-



Interlocking with keylocks.



Interlocking of two devices with rotary handles.

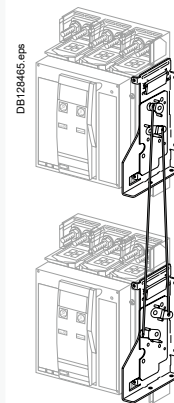

Interlocking with connecting rods.

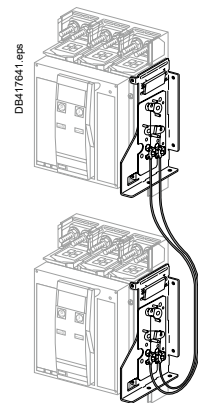

Interlocking with cables.

A

Electrical interlocking is used with a mechanical interlocking system. Moreover, the relays controlling the closing order to the "S1" and "S2" circuit breakers must be mechanically and/or electrically interlocked to prevent them from giving simultaneous closing commands.

PB104831_ME.eps



PB119174_4B.eps



IVE unit.

For ComPact NS630b to NS1600, each circuit breaker must be equipped with:

- a motor mechanism
- an available OF contact
- a CE connected-position contact (carriage switch) on withdrawable circuit breakers
- an SDE contact.

Standard configuration for ComPact NS

Types of mechanical interlocking	Possible combinations	Typical electrical diagrams	Diagram no.
2 devices			
	QN	QR	ComPact NS630b to 1600:
	0	0	■ electrical interlocking with lockout after fault:
	0	1	□ Permanent replacement 51201183 [1] source (with IVE)
	0	1	□ with emergency off by shunt release MX 51201184 [1]
			□ with emergency off by undervoltage release MN 51201185 [1]

[1] See catalogue "Source changeover systems", ref. LVPED211022EN.



Source-changeover system with a controller

In this case, changeovers between the "Normal" and "Replacement" sources under predefined conditions are initiated by a Schneider Electric controller.

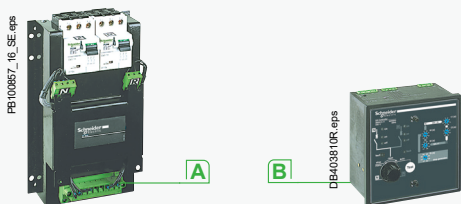

Control plate.

Controller.

Switching between sources can be automated by adding:

- A** ACP control plate
- B** BA or UA controller, or an electrical system provided by the installer for NS630b to 1600. Electrical system example: part no. 51156904 and 51156904 in the source-changeover system catalogue.

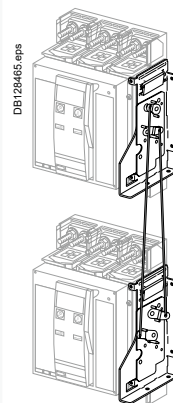

Interlocking by rods.

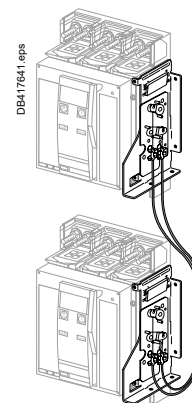

Interlocking by cables.

Source-changeover systems

Associated controllers

A

By combining a remote-operated source-changeover system with an integrated BA or UA automatic controller, it is possible to automatically control source transfer according to user-selected sequences. These controllers can be used on source-changeover systems comprising 2 circuit breakers. For source-changeover systems comprising 3 circuit breakers, the automatic control diagram must be prepared by the installer as a complement to diagrams provided in the “electrical diagrams” section of this catalogue.



BA controller.



UA controller

[1] For example, 220 V single-phase or 220 V three-phase.
 [2] The controller is powered by the ACP control plate. The same voltage must be used for the ACP plate, the IVE unit and the operating mechanisms. If this voltage is the same as the source voltage, then the "Normal" and "Replacement" sources can be used directly for the power supply. If not, an isolation transformer must be used.

Controller		BA	UA
4-position switch			
Compatible circuit breaker		All ComPact NS circuit breaker	
Automatic operation		<input checked="" type="radio"/>	<input checked="" type="radio"/>
Forced operation on "Normal" source		<input checked="" type="radio"/>	<input checked="" type="radio"/>
Forced operation on "Replacement" source		<input checked="" type="radio"/>	<input checked="" type="radio"/>
Stop (both Normal and Replacement sources OFF)		<input checked="" type="radio"/>	<input checked="" type="radio"/>
Automatic operation			
Monitoring of the "Normal" source and automatic transfer		<input checked="" type="radio"/>	<input checked="" type="radio"/>
Generator set startup control			<input checked="" type="radio"/>
Delayed shutdown (adjustable) of engine generator set			<input checked="" type="radio"/>
Load shedding and reconnection of non-priority circuits			<input checked="" type="radio"/>
Transfer to the "Replacement" source if one of the phases of the "Normal" phase is absent			<input checked="" type="radio"/>
Test			
By opening the P25M circuit breaker supplying the controller		<input checked="" type="radio"/>	
By pressing the test button on the front of the controller			<input checked="" type="radio"/>
Indications			
Circuit breaker status indication on the front of the controller: on, off, fault trip		<input checked="" type="radio"/>	<input checked="" type="radio"/>
Automatic mode indication contact		<input checked="" type="radio"/>	<input checked="" type="radio"/>
Other functions			
Selection of type of "Normal" source (single-phase or three-phase) [1]			<input checked="" type="radio"/>
Voluntary transfer to "Replacement" source (e.g. energy-management commands)		<input checked="" type="radio"/>	<input checked="" type="radio"/>
During peak-tariff periods (energy-management commands) forced operation on "Normal" source if "Replacement" source not operational			<input checked="" type="radio"/>
Additional control contact (not in controller). Transfer to "Replacement" source only if contact closed (e.g. used to test the frequency of UR)		<input checked="" type="radio"/>	<input checked="" type="radio"/>
Setting of maximum startup time for the replacement source			<input checked="" type="radio"/>
Power supply			
Control voltages [2]			
	110 V	<input checked="" type="radio"/>	<input checked="" type="radio"/>
	220 to 240 V 50/60 Hz	<input checked="" type="radio"/>	<input checked="" type="radio"/>
	380 to 415 V 50/60 Hz	<input checked="" type="radio"/>	<input checked="" type="radio"/>
	440 V 60 Hz	<input checked="" type="radio"/>	<input checked="" type="radio"/>
Operating thresholds			
Undervoltage		0.35 Un ≤ voltage ≤ 0.7 Un <input checked="" type="radio"/>	<input checked="" type="radio"/>
Phase failure		0.5 Un ≤ voltage ≤ 0.7 Un	<input checked="" type="radio"/>
Voltage presence		voltage ≥ 0.85 Un	<input checked="" type="radio"/>



Controller		BA		UA			
IP degree of protection (EN 60529) and IK degree of protection against external mechanical imPacts (EN 50102)							
Front	IP40	<input checked="" type="radio"/>	<input checked="" type="radio"/>	<input checked="" type="radio"/>	<input checked="" type="radio"/>		
Side	IP30	<input checked="" type="radio"/>	<input checked="" type="radio"/>	<input checked="" type="radio"/>	<input checked="" type="radio"/>		
Connectors	IP20	<input checked="" type="radio"/>	<input checked="" type="radio"/>	<input checked="" type="radio"/>	<input checked="" type="radio"/>		
Front	IK07	<input checked="" type="radio"/>	<input checked="" type="radio"/>	<input checked="" type="radio"/>	<input checked="" type="radio"/>		
Characteristics of output contacts (dry, volt-free contacts)							
Rated thermal current (A)	8						
Minimum load	10 mA at 12 V						
Output contacts:		<input checked="" type="radio"/>	<input checked="" type="radio"/>	<input checked="" type="radio"/>	<input checked="" type="radio"/>		
Position of the Auto/Stop switch							
Load shedding and reconnection order					<input checked="" type="radio"/>		
Generator set start order					<input checked="" type="radio"/>		
		AC			DC		
Utilisation category (IEC 60947-5-1)		AC12	AC13	AC14	AC15	DC12	DC13
Operational current (A)	24 V	8	7	5	6	8	2
	48 V	8	7	5	5	2	-
	110 V	8	6	4	4	0.6	-
	220/240 V	8	6	4	3	-	-
	250 V	-	-	-	-	0.4	-
	380/415 V	5	-	-	-	-	-
	440 V	4	-	-	-	-	-
	660/690 V	-	-	-	-	-	-

Electrical and mechanical accessories

ComPact NS630b to 1600 (fixed version)

A

DB432537 eps

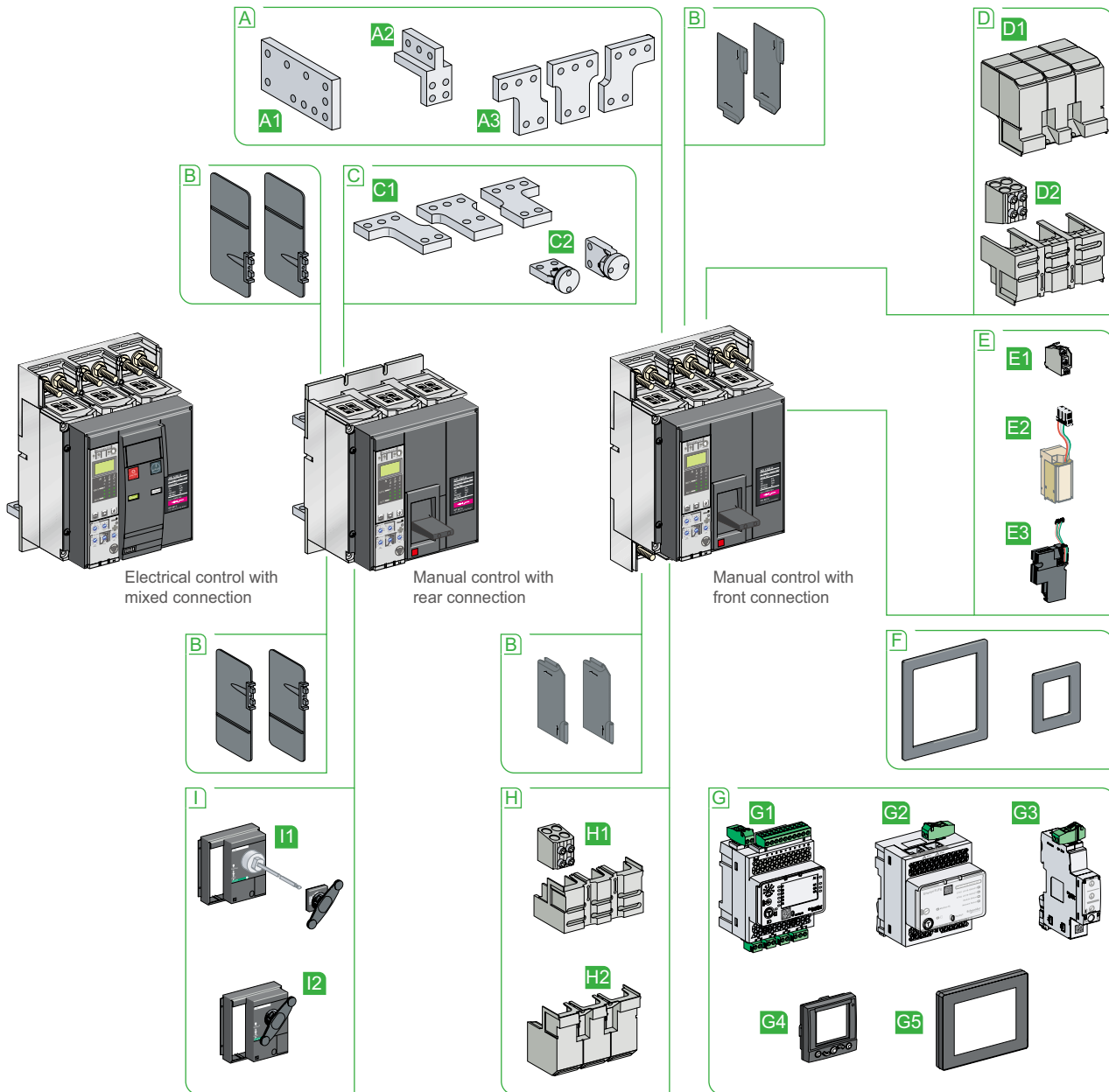

Electrical control with mixed connection

Manual control with rear connection

Manual control with front connection

- A1** Terminal extension for cables with lugs
- A2** Vertical connection adapter
- A3** Spreader
- B** Interphase barriers
- C1** Spreader
- C2** Rear connectors
- D1** Sealable terminal shield
- D2** Connection kit for connectors

- E1** Auxiliary contact
- E2** Voltage release
- E3** Communications module
- F** Escutcheon
- G1** I/O
- G2** IFE
- G3** IFM
- G4** FDM121

- G5** FDM128
- H1** Connection kit for connectors
- H2** Sealable terminal shield
- I1** Extended rotary handle
- I2** Direct rotary handle

Electrical and mechanical accessories ComPact NS630b to 1600 (withdrawable version)

DB432539_e.ppt

A

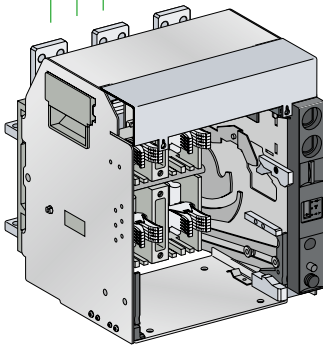
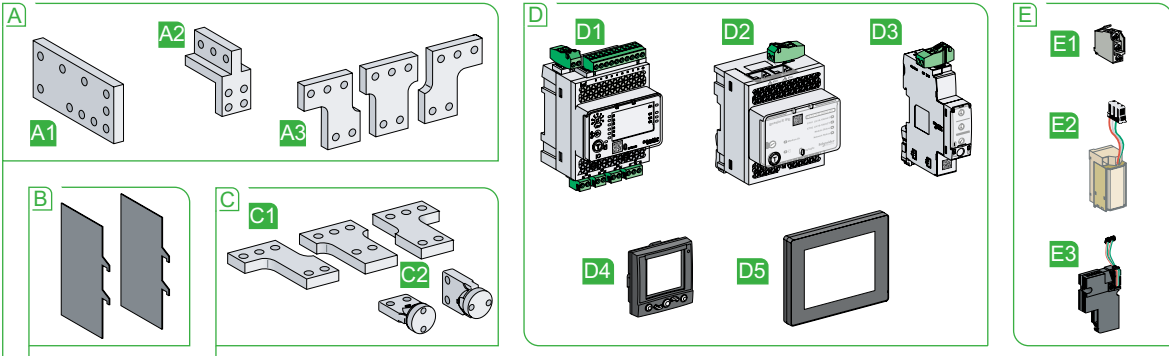

Chassis with front or rear connection

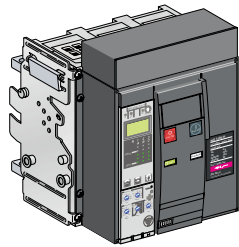

Electrical operation

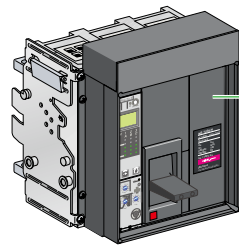

Manual operation

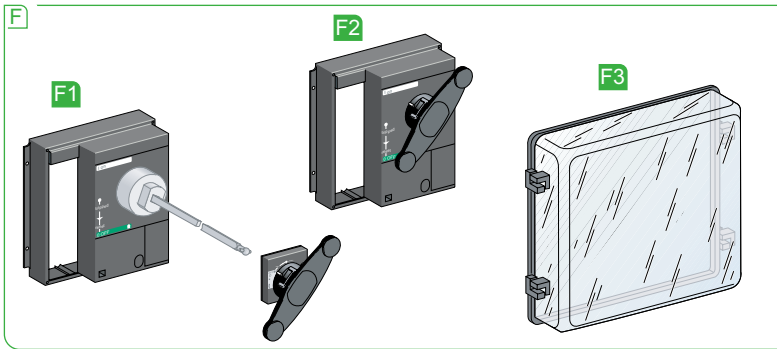
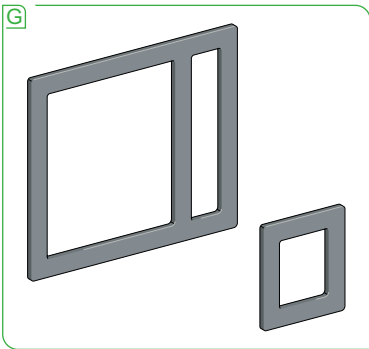

- A1** Terminal extension for cables with lugs
- A2** Vertical connection adapter
- A3** Spreader
- B** Interphase barriers
- C1** Spreader
- C2** Rear connectors
- D1** I/O
- D2** IFE
- D3** IFM
- D4** FDM121
- D5** FDM128

- E1** Auxiliary contact
- E2** Voltage release
- E3** Communications module
- F1** Extended rotary handle
- F2** Direct rotary handle
- F3** Transparent cover
- G** Escutcheon

Electrical and mechanical accessories

ComPact NS630b to 1600

A

The withdrawable configuration makes it possible to:

- extract and/or rapidly replace the circuit breaker without having to touch connections;
- allow for the addition of future circuits at a later date.



PB10360r-50_1.eps

Manually operated fixed ComPact NS800.



PB10481_ME_1.eps

Electrically operated fixed ComPact NS1600.

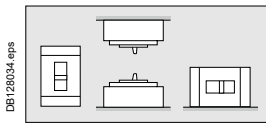

DB128034.eps

Installation

Fixed configuration

ComPact NS630b to 1600 circuit breakers may be installed vertically, horizontally or flat on their back.

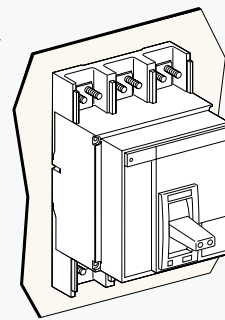

DB128083.eps

Mounting on a backplate.

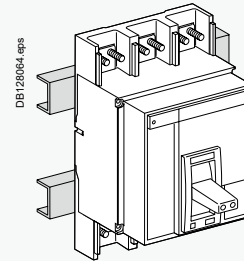

DB128064.eps

Mounting on rails.

Withdrawable configuration

ComPact NS630b to 1600 circuit breakers should be installed vertically only.



DB128051_09_SE_ME_1.eps

Electrically operated withdrawable ComPact NS800H.

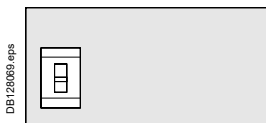

DB128069.eps

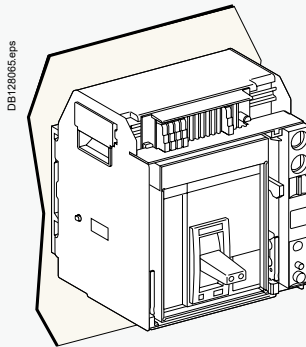

DB128065.eps

Mounting on a backplate.

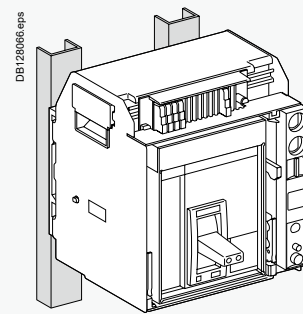

DB128086.eps

Rear mounting on rails.

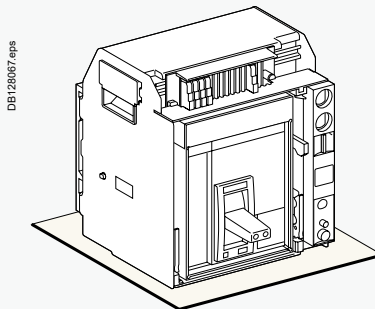

DB128087.eps

Device on mounting plate.

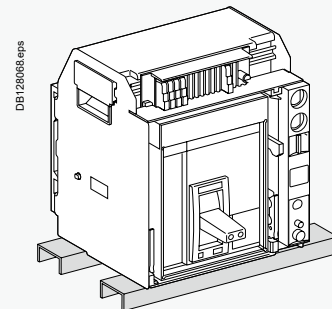

DB128088.eps

Device on rails.

Electrical and mechanical accessories

ComPact NS630b to 1600



The device may be in one of four positions on the chassis:

- connected position. The power circuits and auxiliary contacts are all connected
- test position. The power circuits are disconnected. The auxiliary contacts are still connected and the device can be operated electrically
- disconnected position. The power circuits and auxiliary contacts are all disconnected, however the device is still mounted on the chassis. It can be operated manually (ON, OFF, "push to trip").
- removed position. All circuits are disconnected. The device simply rests on the chassis rails and can be removed.

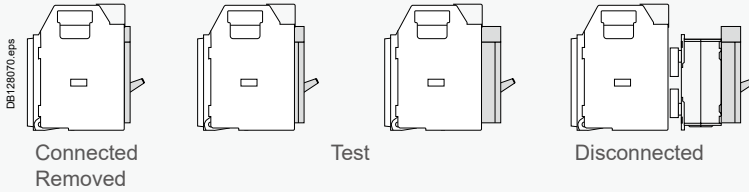

The multifunctional chassis for ComPact NS630b to 1600 devices is particularly suited for incoming circuit breakers. Features include:

- device connection and disconnection through a door, using a crank that can be stored in the chassis
- three positions (connected, test and disconnected) that are indicated:
 - locally by a position indicator
 - remotely by carriage switches (3 for the connected position, 2 for the disconnected position and 1 for the test position)
- circuit breaker ON/OFF commands through a switchboard front panel.

Locking

There are extensive locking possibilities:

- chassis locking in connected, disconnected and test positions using three padlocks and two keylocks, on the switchboard front panel
- door interlock (inhibits door opening with breaker in connected position)
- racking interlock (inhibits racking with door open)
- locking in each of the connected, disconnected and test positions during device connection or disconnection. Continuation to the next position requires pressing a release button to free the crank.

Other safety function

Mismatch protection ensures that a circuit breaker is installed only in a chassis with compatible characteristics.

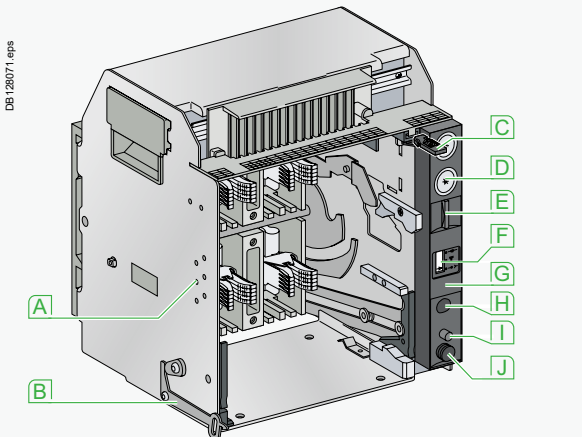

- A** Mismatch protection
- B** Door interlock
- C** Racking interlock
- D** Keylock locking
- E** Padlock locking
- F** Position indicator
- G** Chassis front plate (accessible with cubicle door closed)
- H** Crank entry
- I** Reset button
- J** Crank storage

Electrical and mechanical accessories

ComPact NS630b to 1600

A

Types of connection

Fixed device

Front connections (N, L)

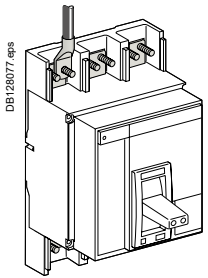

Connection by:

bars



bare cables (except L)



cables with lugs(except L)

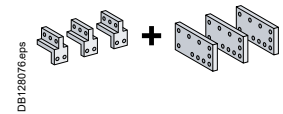
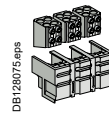

Rear connections (N, L, LB)

Horizontal:

Vertical:

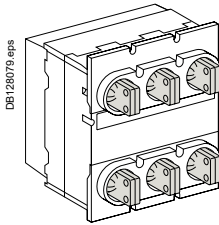
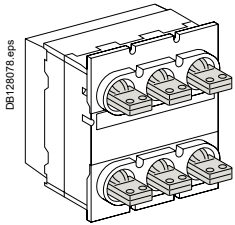

Connection by:

bars



cables with lugs (except L, LB)

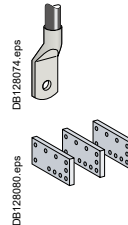

Simply turn a horizontal rear connector 90° to make it a vertical connector.

Combination of front and rear connections (N, L)

Connection by:

bars

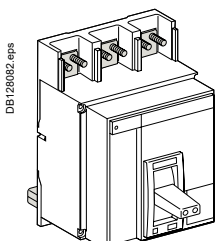
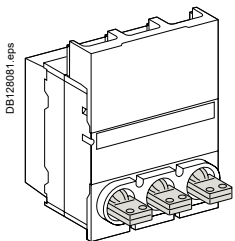

bare cables (except L)

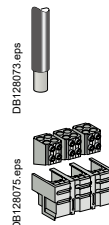

cables with lugs(except L)

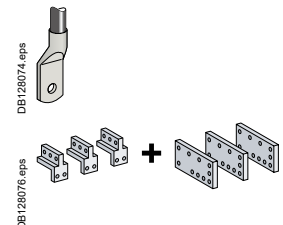

Withdrawable device

Front connections

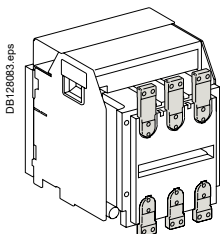

Connection by:

bars



cables with lugs

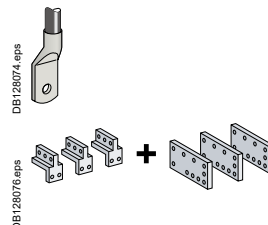

Rear connections

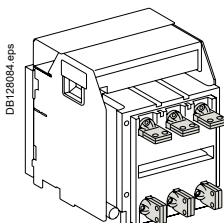

Connection by:

bars



cables with lugs

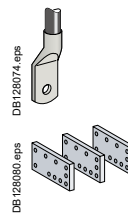

A

To ensure performance and isolation, depending on the type of circuit breaker (N, H, L, LB) and type of connection, certain isolation accessories are mandatory.

Connections accessories

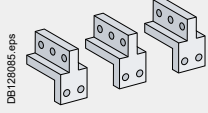
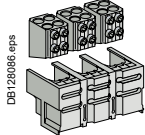
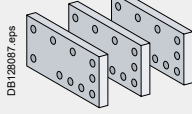
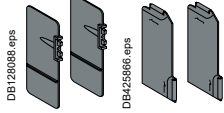
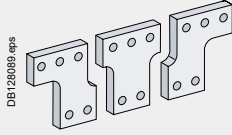
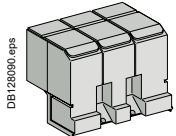
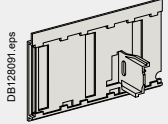
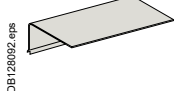
Type of accessories	For ComPact NS630b to NS1600			
	Fixed:		Withdrawable:	
	Front connection	Rear connection	Front connection	Rear connection
Vertical-connection adapters  [1]	N, H	-	N, H, L, LB	-
Set of bare-cable connectors and terminal shields for ratings ≤ 1250 A 	N, H	-	-	-
Cable lug adapters  [1]	N, H	N, H, L, LB	N, H, L, LB	N, H, L, LB
Interphase barriers  [2] [3]	N, H, L, LB	N, H, L, LB	-	N, H, L, LB
Spreaders  [1]	N, H	N, H	N, H, L, LB	N, H, L, LB
Connection shield 	N, H, L	-	-	-
Safety shutters with locking by padlocks (IP20) 	-	-	N, H, L, LB (standard)	N, H, L, LB (standard)
Arc chute screen  [4]	N, H, L	-	-	-

[1] Spreaders, vertical connection adapters and cable lugs adapters are not compatible with voltages $u \geq 500$ V.
 [2] Mandatory for voltages $u \geq 500$ V unless using the bare-cable connector + terminal shield kit.
 [3] Mandatory for fixed devices with L and LB performance levels, whatever the voltage.
 [4] Mandatory for fixed front-connection versions with vertical connection adapters oriented towards the front.

Electrical and mechanical accessories

ComPact NS630b to 1600

A

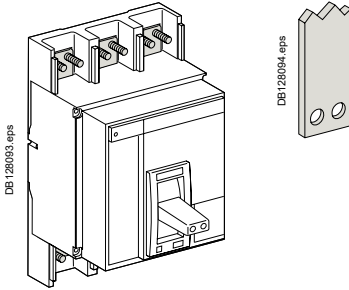

Front connection of fixed devices

Bars

Fixed, front-connection ComPact NS630b to 1600 devices are equipped with terminals comprising captive screws for direct connection of bars. Other connection possibilities for bars include vertical-connection adapters for edgewise bars and spreaders to increase the pole pitch to 95 mm. If the vertical connection adapters are front oriented, then it is mandatory to install the arc chute screen in order to comply with the safety clearances.

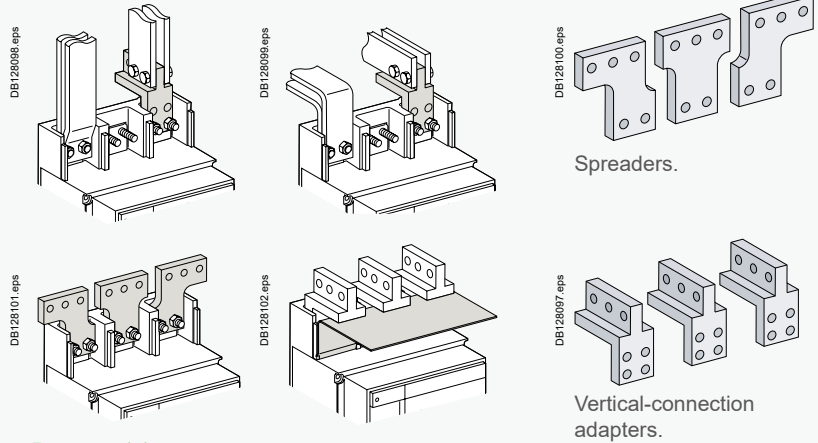

DB128100.eps
Spreaders.

DB128097.eps
Vertical-connection adapters.



Bare cables

Special sets of connectors and terminal shields may be used to connect up to four 240 mm² copper or aluminium cables for each phase. Bare cable connection is possible for ratings up to and including 1250 A.

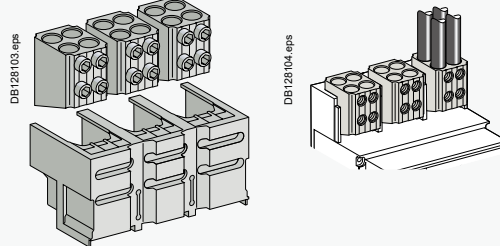

DB128103.eps
4-cable connectors.

Cables with lugs

Cable lug adapters are combined with the vertical-connection adapters. One to four cables with crimped lugs (≤ 300 mm²) may be connected. To ensure stability, spacers must be positioned between the terminal extensions. If the cable lug adapters are installed over the top of the arc chute chambers, then it is mandatory to install the arc chute screen in order to comply with the safety clearances.

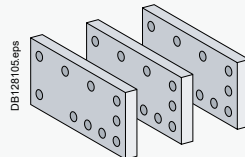

DB128105.eps
Cable lug adapters.

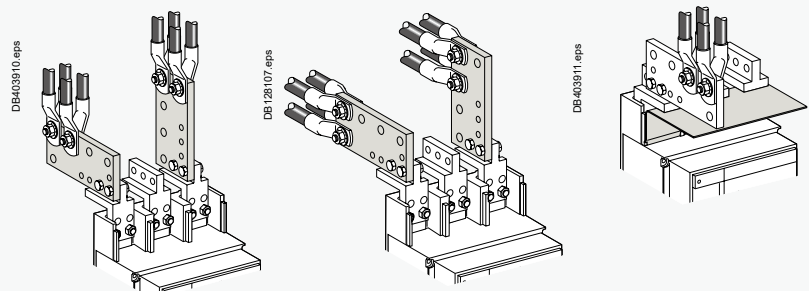

Electrical and mechanical accessories

ComPact NS630b to 1600

Rear connection of fixed devices

Bars

Fixed, rear-connection ComPact NS630b to 1600 devices equipped with horizontal or vertical connectors may be directly connected to flat or edgewise bars, depending on the position of the connectors.
 Spreaders are available to increase the pole pitch to 95 mm.

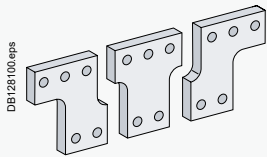

Spreaders.

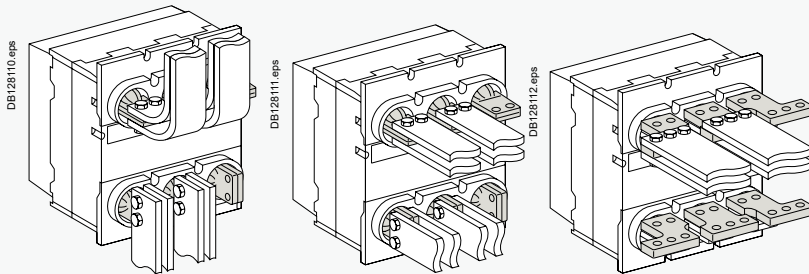

Cables with lugs

Cable lug adapters enable connection of one to four cables with crimped lugs ($\leq 300 \text{ mm}^2$).
 To ensure stability, spacers must be positioned between the terminal extensions.

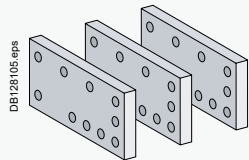

Cable lug adapters.

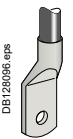
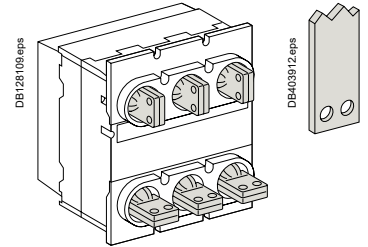
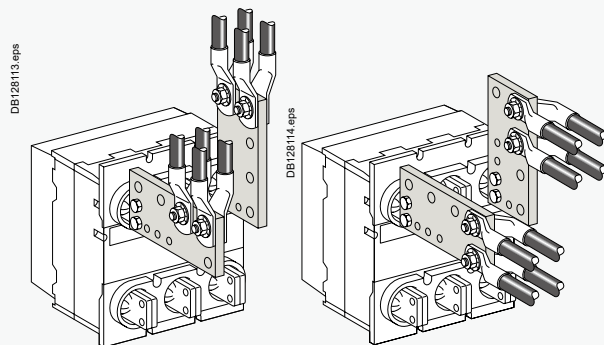

Electrical and mechanical accessories

ComPact NS630b to 1600

A

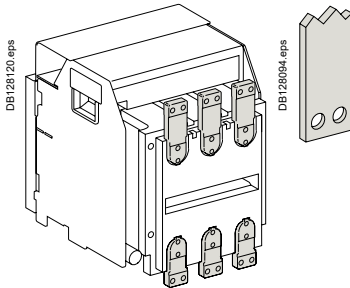

Front connection of withdrawable devices

Bars

Withdrawable, front-connection ComPact NS630b to 1600 devices are suitable for direct connection of bars. Other connection possibilities for bars include vertical-connection adapters for edgewise bars and spreaders to increase the pole pitch to 95 mm.

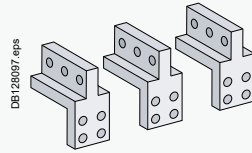

Vertical-connection adapters.

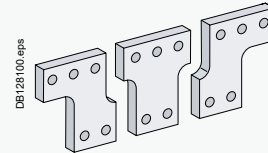

Spreaders.

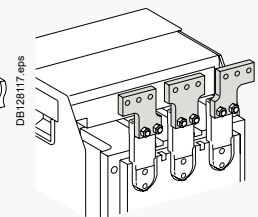
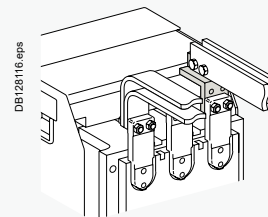
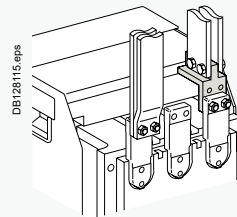

Cables with lugs

Cable lug adapters enable connection of one to four cables with crimped lugs ($\leq 300 \text{ mm}^2$).

To ensure stability, spacers must be positioned between the terminal extensions.

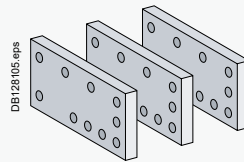

Cable lug adapters.

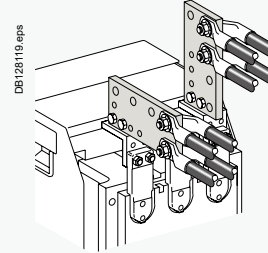
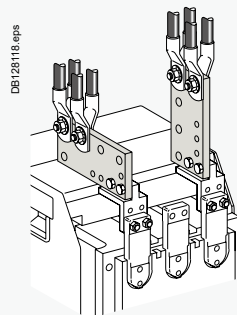



Rear connection of withdrawable devices

Bars

Withdrawable, rear-connection ComPact NS630b to 1600 devices equipped with horizontal or vertical connectors may be directly connected to flat or edge-wise bars, depending on the position of the connectors. Spreaders are available to increase the pole pitch to 95 mm.

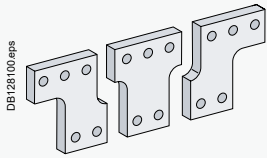

DB128100.eps
 Spreaders.

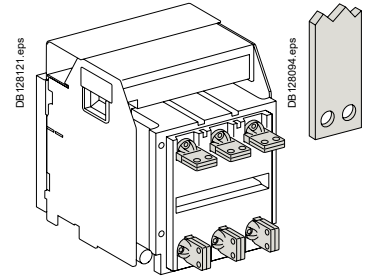
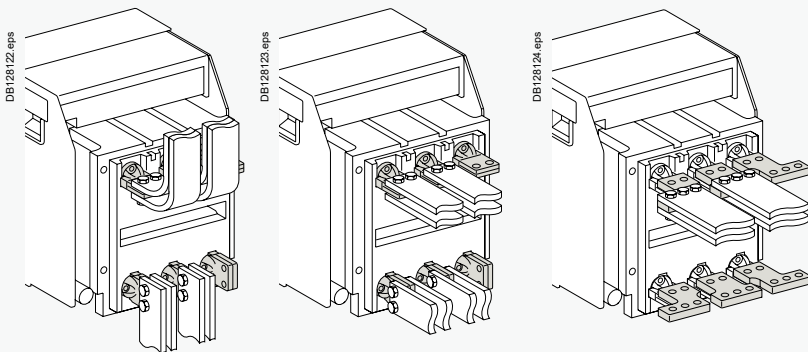

Cables with lugs

Cable lug adapters enable connection of one to four cables with crimped lugs ($\leq 300 \text{ mm}^2$). To ensure stability, spacers must be positioned between the terminal extensions.

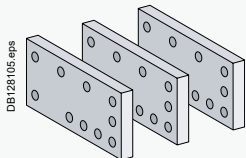

DB128105.eps
 Cable lug adapters.

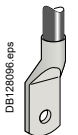
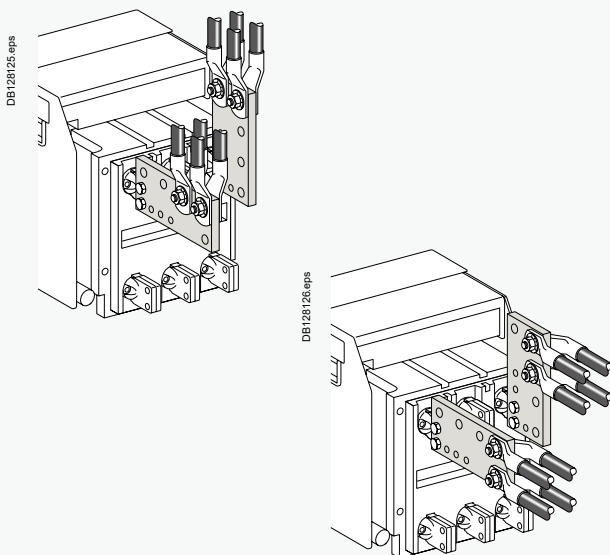

DB128096.eps

Electrical and mechanical accessories

ComPact NS630b to 1600

A

PB104833_1.eps



ComPact NS equipped with connection shield.

Insulation of live parts

Connection shield

Mounted on fixed, front-connection devices, this shield insulates power-connection points, particularly when cables with lugs are used

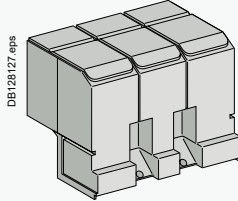

Connection shield.

Interphase barriers

These barriers are flexible insulated partitions used to reinforce isolation of connection points in installations with busbars, whether insulated or not. Barriers are installed vertically between front or rear connection terminals. They are mandatory for voltages ≥ 500 V for both fixed and withdrawable products and for L and LB types, whatever the voltage.

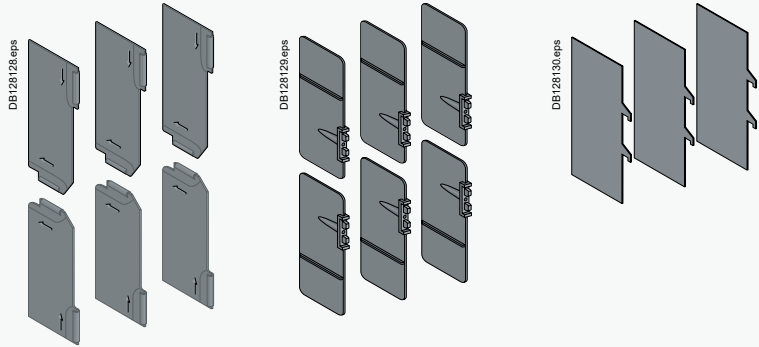

Interphase barriers for fixed device, front connection.

Interphase barriers for fixed device, rear connection.

Interphase barriers for withdrawable device, rear connection.

Safety shutters (standard)

Mounted on the chassis, the safety shutters automatically block access to the disconnecting contact cluster when the device is in the disconnected or test positions (degree of protection IP20). When the device is removed from its chassis, no live parts are accessible.

The shutters can be padlocked (padlock not supplied) to:

- prevent connection of the device
- lock the shutters in the closed position.

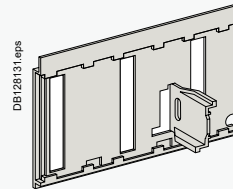

Safety shutters.

Electrical and mechanical accessories

ComPact NS630b to 1600



Connection of electrical auxiliaries

Fixed devices

Connections are made directly to the auxiliaries once the front has been removed. Wires exit the circuit breaker through a knock-out in the top.

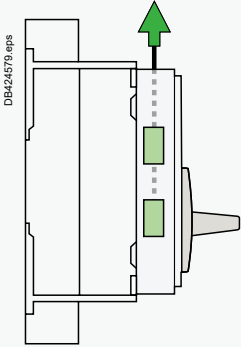

Withdrawable devices

Auxiliary circuits are connected to terminal blocks located in the top part of the chassis. The auxiliary terminal block is made up of a fixed and moving part. The two parts are in contact when the device is in the test and connected positions.

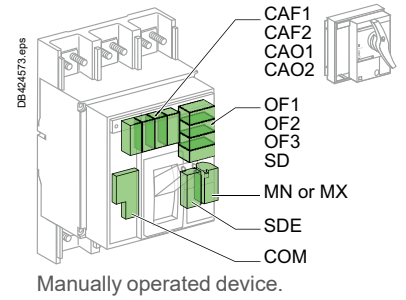
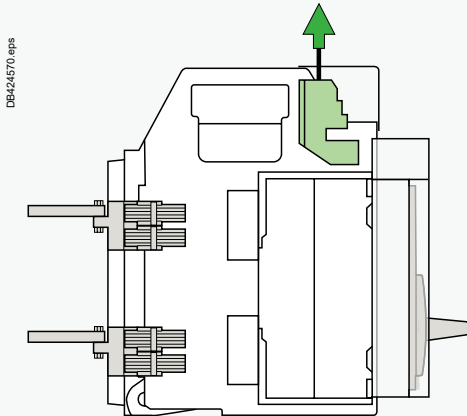

Manually operated device.

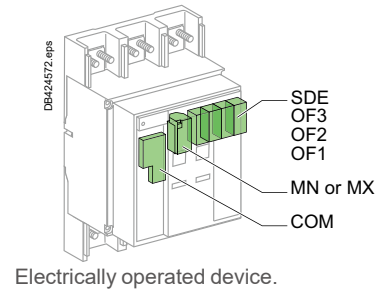

Electrically operated device.

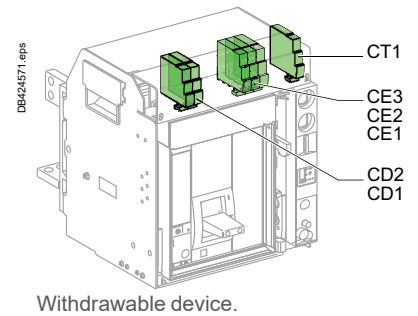

Withdrawable device.

Electrical and mechanical accessories

ComPact NS630b to 1600

A

All the auxiliary contacts opposite are also available in "low-level" versions capable of switching very low loads (e.g. for the control of PLCs or electronic circuits).



OF, SD and SDE changeover contacts.

Indication contacts

Contacts installed in the device

Changeover contacts are used to remote circuit breaker status information and can thus be used for indications, electrical locking, relaying, etc. They comply with the IEC 60947-5 international recommendation.

Functions

- OF (ON/OFF) - indicates the position of the main circuit breaker contacts
- SD (trip indication) - indicates that the circuit breaker has tripped due to:
 - an overload
 - a short-circuit
 - an earth-leakage fault.
- operation of a voltage release
- operation of the "push to trip" button
- disconnection when the device is ON.

Returns to de-energised state when the circuit breaker is reset.

- SDE (fault indication) - indicates that the circuit breaker has tripped due to:

- an overload
- a short-circuit
- an earth-leakage fault.

Returns to de-energised state when the circuit breaker is reset.

- CAF / CAO (early-make or early-break function) - indicates the position of the rotary handle. Used in particular for advanced opening of safety trip devices (early break) or to energise a control device prior to circuit breaker closing (early make).

Installation

- OF, SD and SDE functions - a single type of contact provides all these different indication functions, depending on where it is inserted in the device. The contacts clip into slots behind the front cover of the circuit breaker
- CAF / CAO function - the contact fits into the rotary-handle unit (direct or extended).

Electrical characteristics of the OF/SD/SDE/CAF/CAO auxiliary contacts

Contacts	Standard				Low level				
Rated thermal current (A)	6				5				
Minimum load	100 mA at 24 V				1 mA at 4 V				
Utilisation cat. (IEC 60947-5-1)	AC12	AC15	DC12	DC14	AC12	AC15	DC12	DC14	
Operational current (A)	24 V	6	6	6	1	5	3	5	1
	48 V	6	6	2.5	0.2	5	3	2.5	0.2
	110 V	6	5	0.6	0.05	5	2.5	0.6	0.05
	220/240 V	6	4	-	-	5	2	-	-
	250 V	-	-	0.3	0.03	5	-	0.3	0.03
	380/440 V	6	2	-	-	5	1.5	-	-
	480 V	6	1.5	-	-	5	1	-	-
	660/690 V	6	0.1	-	-	-	-	-	-

Connected, disconnected, test position carriage switches

A single type of changeover contact can be mounted optionally on the chassis to indicate, depending on the slot where it is installed:

- the connected (CE) position
- the disconnected (CD) position. This position is indicated when the required clearance for isolation of the power and auxiliary circuits is reached
- the test (CT) position. In this position, the power circuits are disconnected and the auxiliary circuits are connected.

Installation

- contacts for the connected (CE), disconnected (CD) and test (CT) positions clip into the upper front section of the chassis.

Electrical characteristics of the CE/CD/CT auxiliary contacts

Contacts	Standard				Low level				
Rated thermal current (A)	8				5				
Minimum load	100 mA at 24 V				2 mA at 15 V				
Utilisation cat. (IEC 60947-5-1)	AC12	AC15	DC12	DC14	AC12	AC15	DC12	DC14	
Operational current (A)	24 V	8	6	2.5	1	5	3	5	1
	48 V	8	6	2.5	0.2	5	3	2.5	0.2
	110 V	8	5	0.8	0.05	5	2.5	0.8	0.05
	220/240 V	8	4	-	-	5	2	-	-
	250 V	-	-	0.3	0.03	5	-	0.3	0.03
	380/440 V	8	3	-	-	5	1.5	-	-
	660/690 V	6	0.1	-	-	-	-	-	-

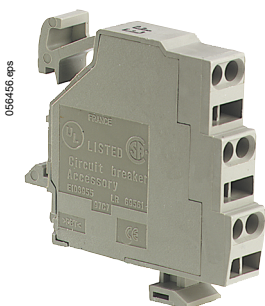

Carriage switches for connected (CE), disconnected (CD) and test (CT) positions.

Functions and characteristics

Electrical and mechanical accessories

ComPact NS630b to 1600

A

Rotary handles

There are two types of rotary handle:

- direct rotary handle
- extended rotary handle.

There are two models:

- standard with a black handle
- VDE with a red handle and yellow front for machine-tool control.

Direct rotary handle

Degree of protection IP40, IK07.

The direct rotary handle maintains:

- visibility of and access to trip unit settings
- suitability for isolation
- indication of the three positions O (OFF), I (ON) and tripped
- access to the "push to trip" button
- circuit breaker locking capability in the OFF position by one to three padlocks, shackle diameter 5 to 8 mm (not supplied).

It replaces the circuit breaker front cover.

Accessories transform the standard direct rotary handle for the following situations:

- a higher degree of protection (IP43, IK07)
- machine-tool control, complying with CNOMO E03.81.501, IP54, IK07.

Extended rotary handle

Degree of protection IP55, IK07.

This handle makes it possible to operate circuit breakers installed at the back of switchboards, from the switchboard front.

It maintains:

- suitability for isolation
- indication of the three positions O (OFF), I (ON) and tripped
- access to trip unit settings, when the switchboard door is open
- circuit breaker locking capability in the OFF position by one to three padlocks, shackle diameter 5 to 8 mm (not supplied).

The door cannot be opened if the circuit breaker is ON or locked.

The extended rotary handle is made up of:

- a unit that replaces the front cover of the circuit breaker (secured by screws)
- an assembly (handle and front plate) on the door that is always secured in the same position, whether the circuit breaker is installed vertically or horizontally
- an extension shaft that must be adjusted to the distance. The min/max distance between the back of circuit breaker and door is 218/605 mm.



ComPact NS with a direct rotary handle.



ComPact NS with an extended rotary handle.

Electrical and mechanical accessories

ComPact NS630b to 1600

A

Manually operated circuit breakers may be equipped with an MX shunt release, an MN undervoltage release or a delayed undervoltage release (MN + delay unit). Electrically operated circuit breakers are equipped as standard with a remote-operating mechanism to remotely open or close the circuit breaker. An MX shunt release or an MN undervoltage release (instantaneous or delayed) may be added.



Fixed ComPact NS800.

Remote tripping

This function opens the circuit breaker via an electrical order. It is made up of:

- a shunt release (2nd MX)
- or an undervoltage release MN
- or a delayed undervoltage release MN + delay unit.

These releases (2nd MX or MN) cannot be operated by the communication bus.

The delay unit, installed outside the circuit breaker, may be disabled by an emergency OFF button to obtain instantaneous opening of the circuit breaker.

Wiring diagram for the remote-tripping function

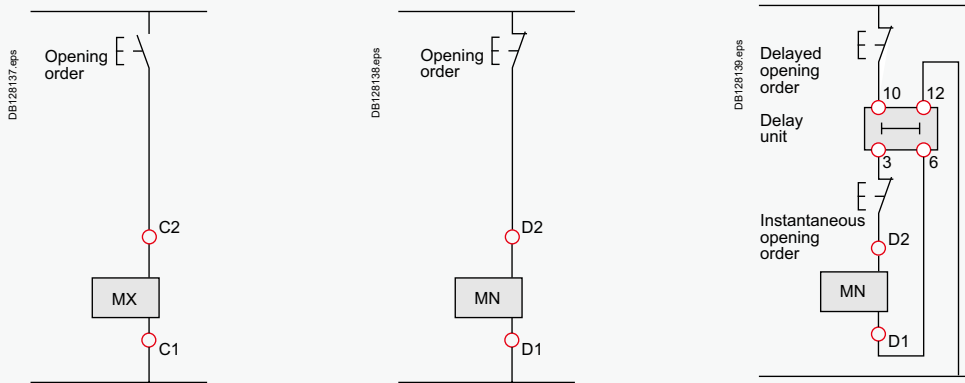

Voltage releases 2nd MX

When energised, the 2nd MX voltage release instantaneously opens the circuit breaker. A continuous supply of power to the 2nd MX locks the circuit breaker in the OFF position. The MX release instantaneously opens the circuit breaker when energised, the minimum duration of the pulse operating order must be 200 ms.

The MX release locks the circuit breaker in OFF position if the order is maintained (except for MX "communicating" releases).

Characteristics		
Power supply	V AC 50/60 Hz	24 - 48 - 100/130 - 200/250 - 277 - 380/480
	V DC	12 - 24/30 - 48/60 - 100/130 - 200/250
Operating threshold		0.7 to 1.1 Un
Permanent locking function		0.85 to 1.1 Un
Consumption (VA or W)		pick-up: 200 (200 ms) hold: 4.5
Circuit breaker response time at Un		50 ms ±10

Instantaneous voltage releases MN

The MN release instantaneously opens the circuit breaker when its supply voltage drops to a value between 35 % and 70 % of its rated voltage. If there is no supply on the release, it is impossible to close the circuit breaker, either manually or electrically. Any attempt to close the circuit breaker has no effect on the main contacts. Circuit breaker closing is enabled again when the supply voltage of the release returns to 85 % of its rated value.

Characteristics		
Power supply	V AC 50/60 Hz	24 - 48 - 100/130 - 200/250 - 380/480
	V DC	24/30 - 48/60 - 100/130 - 200/250
Operating threshold	opening	0.35 to 0.7 Un
	closing	0.85 Un
Consumption (VA or W)		pick-up: 200 (200 ms) hold: 4.5
MN consumption with delay unit (VA or W)		pick-up: 400 (200 ms) hold: 4.5
Circuit breaker response time at Un		90 ms ±5

MN delay units

To eliminate circuit breaker nuisance tripping during short voltage dips, operation of the MN release can be delayed. This function is achieved by adding an external delay unit in the MN voltage-release circuit. Two versions are available, adjustable and non-adjustable.

Characteristics		
Power supply	non-adjustable	100/130 - 200/250
	adjustable	48/60 - 100/130 - 200/250 - 380/480
Operating threshold	opening	0.35 to 0.7 Un
	closing	0.85 Un
Consumption of delay unit alone (VA or W)		pick-up: 200 (200 ms) hold: 4.5
Circuit breaker response time at Un	non-adjustable	0.25 s
	adjustable	0.5 s - 1 s - 1.5 s - 3 s



Fixed ComPact NS1600.



MX voltage release.

Electrical and mechanical accessories

ComPact NS630b to 1600



Electrically operated circuit breakers are equipped as standard with a motor mechanism module. Two solutions are available for electrical operation:

- a point-to-point solution
- a bus solution with the COM communication option.

Electrically operated circuit breaker

The motor mechanism module is used to remotely open and close the circuit breaker. It is made up of a spring-charging motor equipped with an opening release and a closing release.

An electrical operation function is generally combined with:

- device ON/OFF indication OF
- "fault-trip" indication SDE.

Motor mechanism module

Power supply	V AC 50/60 Hz	48/60 - 100/130 - 200/240 - 277 - 380/415
	V DC	24/30 - 48/60 - 100/125 - 200/250
Operating threshold		0.85 to 1.1 Un
Consumption (VA or W)		180
Motor overcurrent		2 to 3 In for 0.1 second
Charging time		maximum 4 seconds
Operating frequency		maximum 3 cycles per minute

Electrical closing order

The release remotely closes the circuit breaker if the spring mechanism is charged. Release electrical characteristics are identical to those of an MX release (see above), the operating threshold is from 0.85 to 1.1 Un and the circuit breaker response time at Un is 60 ms ± 10.

The ComPact NS electrical operation function can be used to implement a synchronizing system.

Electrical opening order

The release instantaneously opens the circuit breaker when energised. The supply can be impulse-type or maintained.

Release electrical characteristics are identical to those of an MX release (see above).

Note: whether the operating order is maintained or automatically disconnected (pulse-type), "communicating" releases ("bus" solution with "COM" communication option) always have an impulse-type action (see diagram).



Electrically operated ComPact NS circuit breaker.

Wiring diagram of a point-to-point electrical operation solution

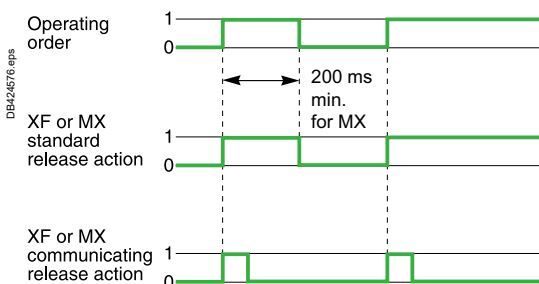
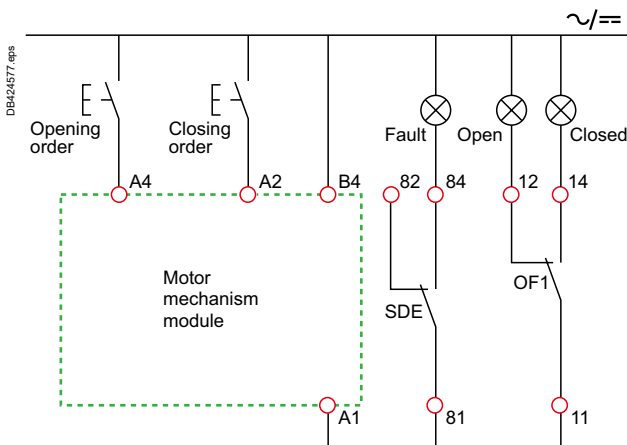

Wiring diagram of a bus-type electrical operation solution

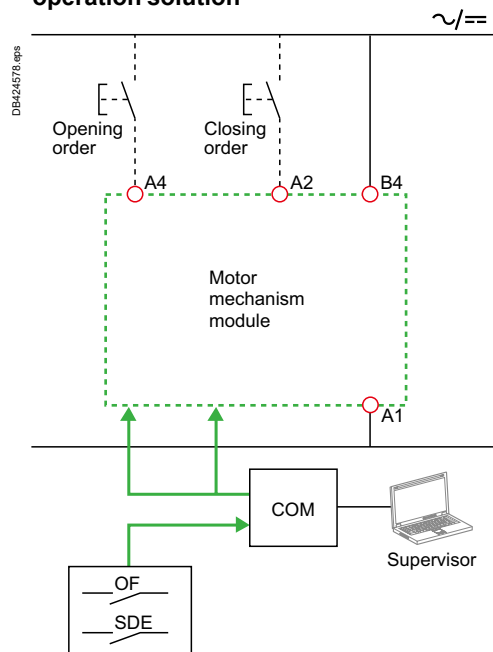

In the event of simultaneous opening and closing orders, the mechanism discharges without any movement of the main contacts.

In the event of maintained opening and closing orders, the standard electrical operation solution provides an anti-pumping function by blocking the main contacts in open position.

Electrical and mechanical accessories

ComPact NS630b to 1600

A



PB104830_ME_L_1.eps

Toggle locked by removable padlocking device.



PB104820_ME_L_1.eps

Rotary handle locked by a keylock.

Locking on manually operated devices

Locking in the OFF position guarantees isolation as per IEC 60947-2. Padlocking systems can receive up to three padlocks with shackle diameters ranging from 5 to 8 mm (padlocks not supplied).

Control device	Function	Means	Required accessories
Toggle	lock in		
	■ OFF position	padlock	removable device
	■ OFF or ON position	padlock	fixed device
Direct rotary handle	lock in		
	■ OFF position	padlock	
	■ OFF or ON position	keylock	locking device + keylock
CNOMO direct rotary lock in handle	■ OFF position	padlock	
Extended rotary handle	lock in OFF position,	padlock	
	door opening prevented	keylock	keylock

Locking in ON position does not prevent the device from tripping in the event of a fault or remote tripping order.

Locking on electrically operated devices

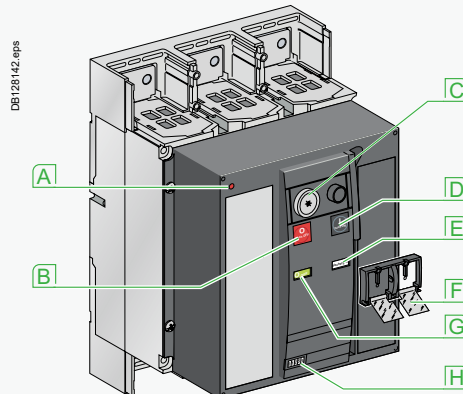

DB128142.eps

- A** reset of mechanical trip indicator
- B** OFF pushbutton
- C** OFF position locking
- D** ON pushbutton
- E** springs charged indication
- F** pushbutton locking
- G** contact position indication
- H** operation counter

Pushbutton locking VBP

The transparent cover blocks access to the pushbuttons used to open and close the device.

It is possible to independently lock the opening OFF button and the closing ON button.

The pushbuttons may be locked using either:

- padlocks (not supplied), 5 to 8 mm
- lead seal
- two screws.

Device locking in the OFF position VCPO by padlocks, VSPO by keylocks

The circuit breaker is locked in the OFF position by physically maintaining the opening pushbutton pressed down:

- using padlocks in standard (one to three padlocks, not supplied)
- using a keylock (supplied).

Keys may be removed only when locking is effective (Profalux or Ronis type locks).

The keylocks are available in any of the following configurations:

- one keylock
- one keylock mounted on the device + one identical keylock supplied separately for interlocking with another device.

A locking kit (without lock) is available for installation of a keylock (Ronis, Profalux, Kirk or Castell).



PB100811A-32.eps

Access to pushbuttons protected by transparent cover.



PB100810A-32.eps

Pushbutton locking using a padlock.

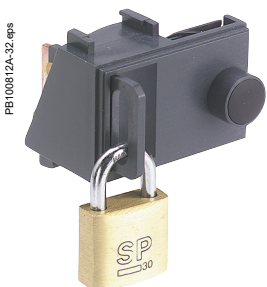

PB100812A-32.eps

OFF locking using padlocks.



PB104365A-32.eps

OFF position locking using a keylock and padlocks.

Electrical and mechanical accessories

ComPact NS630b to 1600



Chassis locking

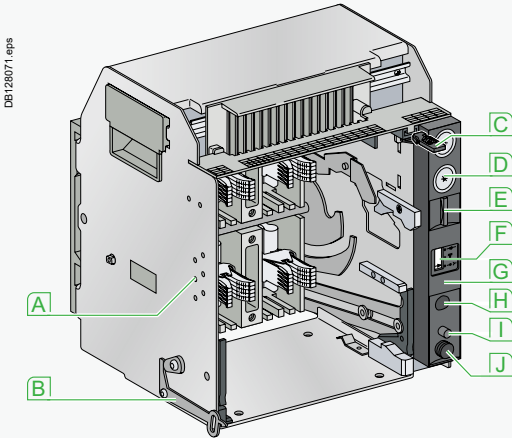

- A** mismatch protection
- B** door interlock
- C** racking interlock
- D** keylock locking
- E** padlock locking
- F** position indicator
- G** chassis front plate (accessible with cubicle door closed)
- H** crank entry
- I** reset button
- J** crank storage

"Disconnected" position locking by padlocks (standard) or keylocks (VSPD option)

Mounted on the chassis and accessible with the door closed, these devices lock the circuit breaker in the disconnected position in two manners:

- using padlocks (standard), up to three padlocks (not supplied)
- using keylocks (optional), one or two different keylocks are available.

Profalux and Ronis keylocks are available in different options:

- one keylock
- one keylock mounted on the device + one identical keylock supplied separately, using the same key, for interlocking with another device
- one (or two) keylocks mounted on the device + one (or two) identical keylocks supplied separately, for interlocking with another device.

A locking kit (without locks) is available for installation of one or two keylocks (Ronis, Profalux, Kirk or Castell).

"Connected", "disconnected" and "test" position locking

The connected, disconnected and test positions are shown by an indicator and are mechanically indexed.

The racking crank blocks when the exact position is obtained.

A release button is used to free it.

As standard, the circuit breaker can be locked only in "disconnected position". On request, the locking system may be modified to lock the circuit breaker in any of the three positions: "connected", "disconnected" or "test".

Door interlock catch VPEC

Mounted on the right or left-hand side of the chassis, this device inhibits opening of the cubicle door when the circuit breaker is in connected or test position. If the breaker is put in the connected position with the door open, the door may be closed without having to disconnect the circuit breaker.

Racking interlock VPOC

This device prevents insertion of the crank when the cubicle door is open (device cannot be connected).

Mismatch protection VDC

Mismatch protection ensures that a circuit breaker is installed only in a chassis with compatible characteristics. It is made up of two parts (one on the chassis and one on the circuit breaker) offering twenty different combinations that the user may select.



"Disconnected" position locking by padlocks.



"Disconnected" position locking by keylocks.

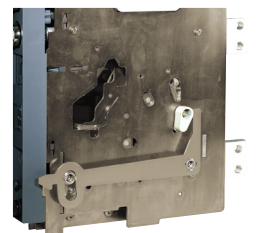

Door interlock.

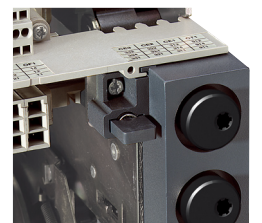

Racking interlock.

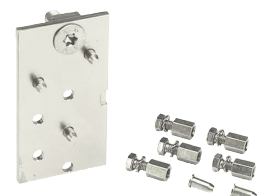

Mismatch protection.

Electrical and mechanical accessories

ComPact NS630b to 1600

A



PB104740-32.eps

Auxiliary terminal shield.

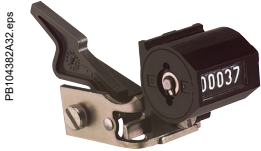

PB104382A32.eps

Operation counter.

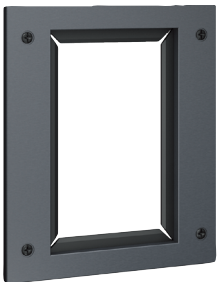

DB128144.eps

Escutcheon.

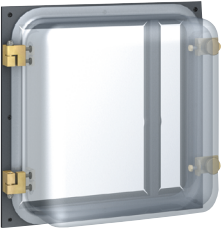

DB128145.eps

Transparent cover.

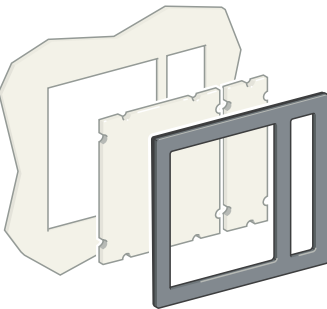

DB128146.eps

Blanking plate.

Other accessories

Auxiliary terminal shield (CB)

Optional equipment mounted on the chassis, the shield prevents access to the terminal block of the electrical auxiliaries.

Operation counter (CDM)

The operation counter sums the number of operating cycles and is visible on the front panel. This option is mandatory for Source-changeover systems and only compatible with electrically operated devices.

Escutcheon (CDP)

Optional equipment mounted on the door of the cubicle, the escutcheon increases the degree of protection to IP40. It is available in fixed and withdrawable versions.

Transparent cover (CCP) for escutcheon

Optional equipment mounted on the escutcheon, the cover is hinged and secured by a screw. It increases the degree of protection to IP54 and the degree of protection against mechanical imPacts to IK10. It may be used for withdrawable devices only.

Blanking plate (OP) for escutcheon

Used with the escutcheon, this option closes off the door cutout of a cubicle not yet equipped with a device. It may be used with the escutcheon for both fixed and withdrawable devices.

Electrical and mechanical accessories

ComPact NS1600b to 3200 (fixed version)

A

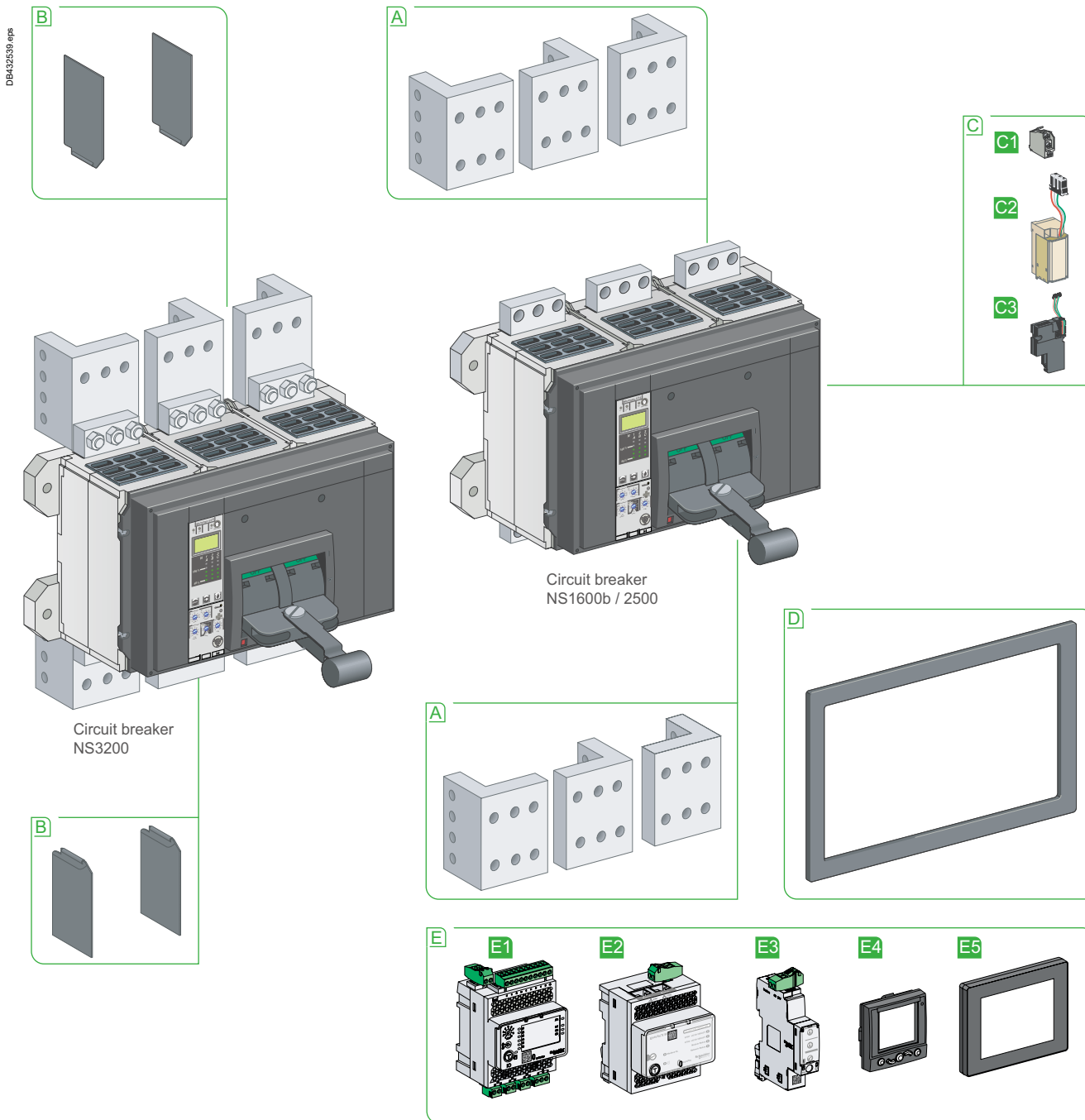

- A** Vertical-connection adapters
- B** Interphase barriers
- C1** Auxiliary contact
- C2** Voltage release
- C3** Communications module
- D** Escutcheon

- E1** I/O
- E2** IFE
- E3** IFM
- E4** FDM121
- E5** FDM128

Electrical and mechanical accessories

ComPact NS1600b to 3200

A



PB106368_LB1.eps

Fixed ComPact NS.

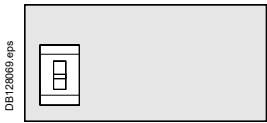

DB128069.eps

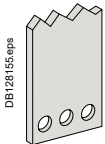

DB128155.eps

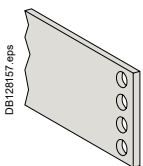

DB128157.eps

Installation

Fixed circuit breakers

ComPact NS1600b to 3200 circuit breakers should be installed vertically only.

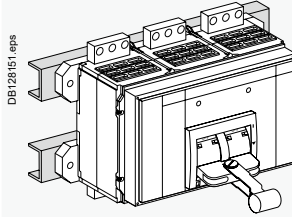

DB128151.eps

Mounting on rails.

Connection

Front connection

NS1600 to 2500

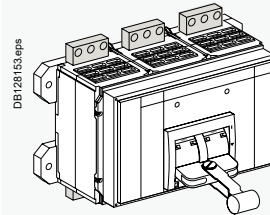

DB128153.eps

NS3200

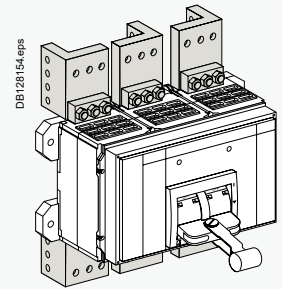

DB128154.eps

Bars

Bars may be directly connected to the terminals of ComPact NS1600b to 3200 circuit breakers.

NS1600b to 2500

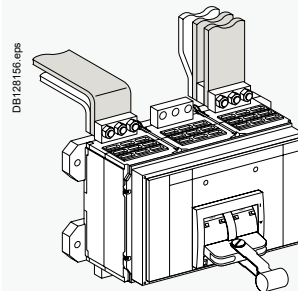

DB128156.eps

NS1600b to 2500 with connection for vertical-connection adapters or NS3200

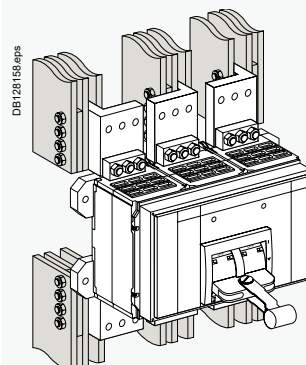

DB128158.eps

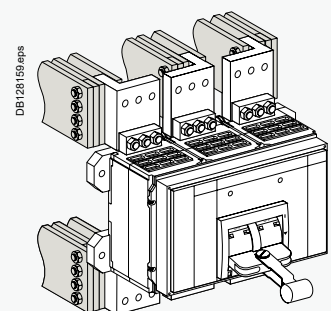

DB128159.eps

Electrical and mechanical accessories

ComPact NS1600b to 3200



All the auxiliary contacts opposite are also available in "low-level" versions capable of switching very low loads (e.g. for the control of PLCs or electronic circuits).

Indication contacts

Contacts installed in the device

Changeover contacts are used to remote circuit breaker status information and can thus be used for indications, electrical locking, relaying, etc. They comply with the IEC 60947-5 international recommendation.

Functions

- OF (ON/OFF) - indicates the position of the main circuit breaker contacts
- SD (trip indication) - indicates that the circuit breaker has tripped due to:
 - an overload
 - a short-circuit
 - an earth-leakage fault
 - operation of a voltage release
 - operation of the "push to trip" button
- Returns to de-energised state when the circuit breaker is reset.
- SDE (fault indication) - indicates that the circuit breaker has tripped due to:
 - an overload
 - a short-circuit
 - an earth-leakage fault.
- Returns to de-energised state when the circuit breaker is reset.

Installation

- OF, SD and SDE functions - a single type of contact provides all these different indication functions, depending on the position where it is inserted in the device. The contacts clip into slots behind the front cover of the circuit breaker.

Electrical characteristics of the OF/SD/SDE auxiliary contacts

Contacts	Standard				Low level				
Rated thermal current (A)	6				5				
Minimum load	100 mA at 24 V				1 mA at 4 V				
Utilisation cat. (IEC 60947-5-1)	AC12	AC15	DC12	DC14	AC12	AC15	DC12	DC14	
Operational current (A)	24 V	6	6	6	1	5	3	5	1
	48 V	6	6	2.5	0.2	5	3	2.5	0.2
	110 V	6	5	0.6	0.05	5	2.5	0.6	0.05
	220/240 V	6	4	-	-	5	2	-	-
	250 V	-	-	0.3	0.03	5	-	0.3	0.03
	380/440 V	6	2	-	-	5	1.5	-	-
	480 V	6	1.5	-	-	5	1	-	-
	660/690 V	6	0.1	-	-	-	-	-	-



OF, SD and SDE changeover contacts.

Electrical and mechanical accessories

ComPact NS1600b to 3200

A

ComPact NS1600b to 3200 circuit breakers may be equipped with an MX shunt release, an MN undervoltage release or a delayed undervoltage release (MNR = MN + delay unit).

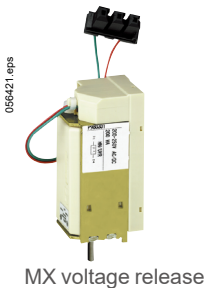

MX voltage release

Remote tripping

This function opens the circuit breaker via an electrical order. It is made up of:

- a shunt release 2nd MX
- or an undervoltage release MN
- or a delayed undervoltage release MNR = MN + delay unit.

These releases (2nd MX or MN) cannot be operated by the communication bus.

The delay unit, installed outside the circuit breaker, may be disabled by an emergency OFF button to obtain instantaneous opening of the circuit breaker.

Wiring diagram for the remote-tripping function

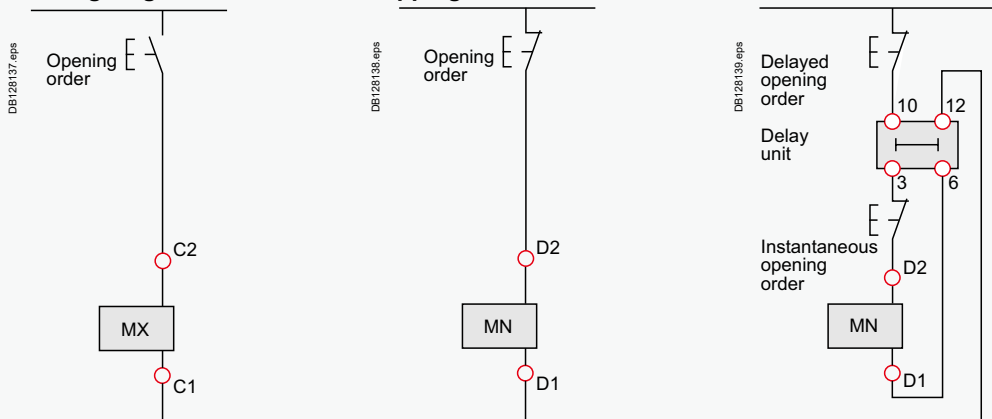

Voltage releases 2nd MX

When energised, the 2nd MX voltage release instantaneously opens the circuit breaker. A continuous supply of power to the 2nd MX locks the circuit breaker in the OFF position.

Characteristics

Power supply V AC 50/60 Hz	24 - 48 - 100/130 - 200/250 - 277 - 380/480
V DC	12 - 24/30 - 48/60 - 100/130 - 200/250
Operating threshold	0.7 to 1.1 Un
Permanent locking function	0.85 to 1.1 Un
Consumption (VA or W)	pick-up: 200 (80 ms) hold: 4.5
Circuit breaker response time at Un	50 ms ± 10

Instantaneous voltage releases MN

The MN release instantaneously opens the circuit breaker when its supply voltage drops to a value between 35 % and 70 % of its rated voltage. If there is no supply on the release, it is impossible to close the circuit breaker, either manually or electrically. Any attempt to close the circuit breaker has no effect on the main contacts. Circuit breaker closing is enabled again when the supply voltage of the release returns to 85 % of its rated value.

Characteristics

Power supply V AC 50/60 Hz	24 - 48 - 100/130 - 200/250 - 380/480
V DC	24/30 - 48/60 - 100/130 - 200/250
Operating threshold opening	0.35 to 0.7 Un
threshold closing	0.85 Un
Consumption (VA or W)	pick-up: 200 (200 ms) hold: 4.5
MN consumption with delay unit (VA or W)	pick-up: 400 (200 ms) hold: 4.5
Circuit breaker response time at Un	90 ms ± 5

MN delay units

To eliminate circuit breaker nuisance tripping during short voltage dips, operation of the MN release can be delayed. This function is achieved by adding an external delay unit in the MN voltage-release circuit. Two versions are available, adjustable and non-adjustable.

Characteristics

Power supply V AC 50-60 Hz / DC	non-adjustable	100/130 - 200/250
	adjustable	48/60 - 100/130 - 200/250 - 380/480
Operating threshold opening	0.35 to 0.7 Un	
	closing	0.85 Un
Consumption of delay unit alone (VA or W)	pick-up: 200 (200 ms)	hold: 4.5
Circuit breaker response time at Un	non-adjustable	0.25 s
	adjustable	0.5 s - 0.9 s - 1.5 s - 3 s

Functions and characteristics

Electrical and mechanical accessories

ComPact NS1600b to 3200



ComPact NS with toggle locked using a fixed device and padlocks.



ComPact NS with toggle locked using a removable device and padlocks.

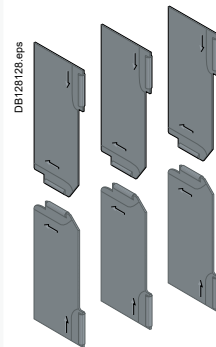

Interphase barriers.

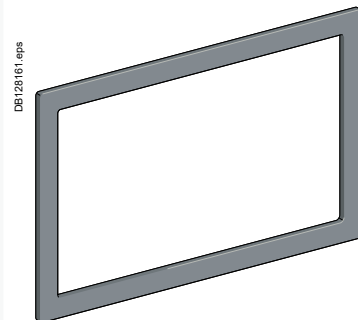

Escutcheon.



Micrologic 6.0 E

4.3 V

N 1 2 3
A B C

100%
40%

menu

Schneider

Compact

U _i 600 V	U _{imp} 8 kV
220/240 ~	85 35
380/415 ~	70 35
440 ~	65 32
500/525 ~	50 25
690/690 ~	42 21

low 10 2kA / 1s cat B

50/60Hz IEC 60947-2

Installation recommendations

Operating conditions	B-2
Installation in switchboards	
Power supply and weights	B-3
Safety clearances and minimum distances	B-4
Installation example	B-5
Door interlock for ComPact NS630b to 1600	B-6
Control wiring.....	B-7
Temperature derating	
ComPact NS devices equipped with electronic trip units.....	B-8
Power dissipation / Resistance	
ComPact NS devices equipped with electronic trip units.....	B-9

B

ComPact circuit breakers have been tested for operation in industrial atmospheres. It is recommended that the equipment be cooled or heated to the proper operating temperature and kept free of excessive vibration and dust.

B

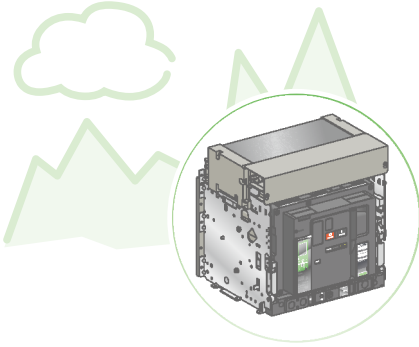

DB419120.eps

Altitude derating

Altitude does not significantly affect circuit-breaker characteristics up to 2000 m. Above this altitude, it is necessary to take into account the decrease in the dielectric strength and cooling capacity of air. The following table gives the corrections to be applied for altitudes above 2000 metres. The breaking capacities remain unchanged.

ComPact NS630b to 3200

Altitude (m)	2000	3000	4000	5000
Impulse withstand voltage U_{imp} (kV)	8	7.1	6.4	5.6
Rated insulation voltage (U_i)	1000	900	780	700
Maximum rated operational voltage 50/60 Hz U_e (V)	690	690	635	560
Rated current 40 °C	1 x I_n	0.99 x I_n	0.96 x I_n	0.94 x I_n

Intermediate values may be obtained by interpolation.

Vibrations

ComPact NS devices resist electromagnetic or mechanical vibrations. Tests are carried out in compliance with standard IEC 60068-2-6 for the levels required by merchant-marine inspection organisations (Veritas, Lloyd's, etc.):

- 2 → 13.2 Hz: amplitude ± 1 mm
- 13.2 → 100 Hz: constant acceleration 0.7 g.

Excessive vibration may cause tripping, breaks in connections or damage to mechanical parts.

DB419119.eps

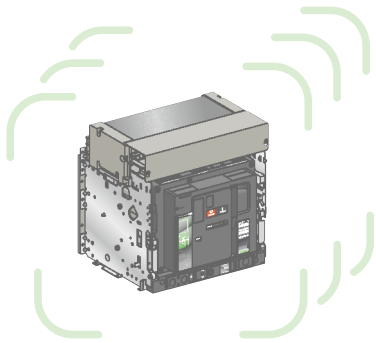

Electromagnetic disturbances

ComPact NS devices are protected against:

- overvoltages caused by devices that generate electromagnetic disturbances
- overvoltages caused by an atmospheric disturbances or by a distribution-system outage (e.g. failure of a lighting system)
- devices emitting radio waves (radios, walkie-talkies, radar, etc.)
- electrostatic discharges produced by users.

ComPact NS devices have successfully passed the electromagnetic-compatibility tests (EMC) defined by the following international standards:

- IEC 60947-2, appendix F
- IEC 60947-2, appendix B (trip units with Vigi earth-leakage function).

The above tests guarantee that:

- no nuisance tripping occurs
- tripping times are respected.

DB419121.eps

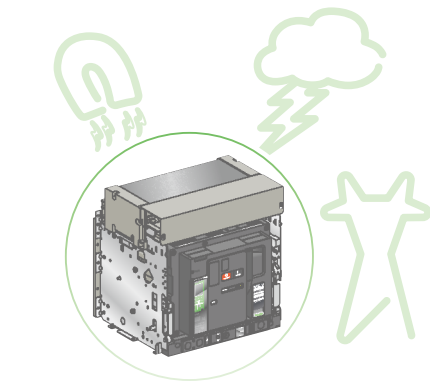

Installation recommendations

Installation in switchboards

Power supply and weights

Power supply

ComPact NS circuit breakers can be supplied from either the top or the bottom without any reduction in performance. This capability facilitates connection when installed in a switchboard.

Weights

		Circuit breaker	Chassis
NS630b to 1600 manual operation	3P	14	14
	4P	18	18
NS630b to 1600 electrical operation	3P	14	16
	4P	18	21
NS1600b to 3200	3P	24	-
	4P	36	-

The table above presents the weights (in kg) of the circuit breakers and the main accessories, which must be summed to obtain the total weight of complete configurations.

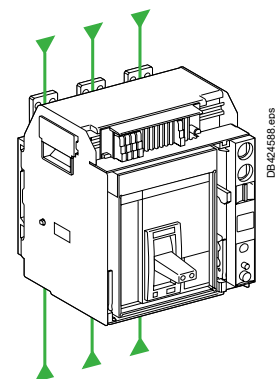

B

Installation in switchboards

Safety clearances and minimum distances

B

General rules

When installing a circuit breaker, minimum distances (safety clearances) must be maintained between the device and panels, bars and other protection devices installed nearby. These distances, which depend on the ultimate breaking capacity, are defined by tests carried out in accordance with standard IEC 60947-2.

If installation conformity is not checked by type tests, it is also necessary to:

- use insulated bars for circuit-breaker connections
- block off the busbars using insulating screens.

ComPact NS630b to 3200 (fixed devices)

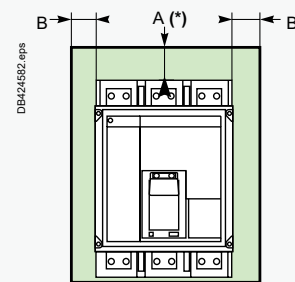
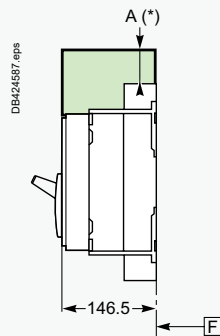

[1] An overhead clearance of 50 mm is required to remove the arc chutes.

	Insulated parts	Metal parts	Live parts
NS630b to 1600			
A	0	120	180
B	0	10	60
NS1600b to 3200			
A	50	170	230
B	0	10	60

ComPact NS630b to 1600 (withdrawable devices)

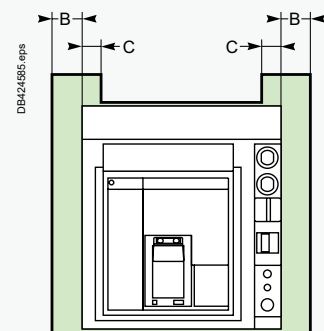
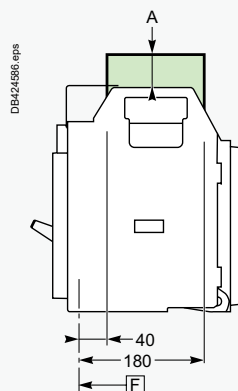

	Insulated parts	Metal parts	Live parts
A	0	0	30
B	10	10	60
C	0	0	30

F Datum

Installation recommendations

Installation in switchboards

Installation example

DB424553.eps

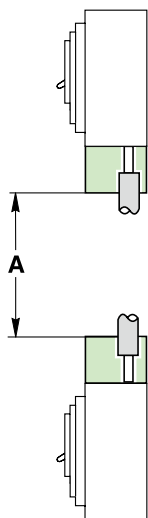

Direct connection by bare cables, devices with terminal shields.

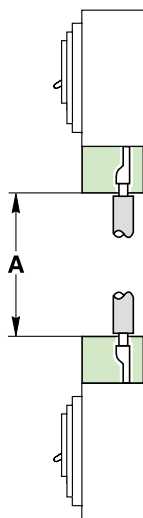

Connection by cables with lugs, devices with terminal shields.

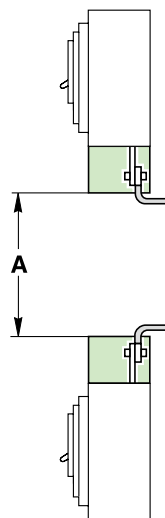

Connection by insulated bars, devices with terminal shields.

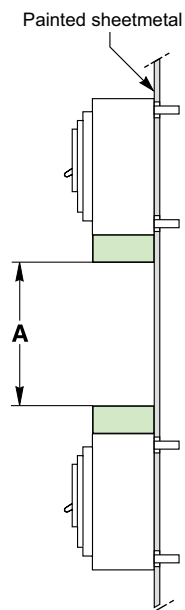

Rear connection devices with terminal shields.

Minimum dimensions (mm)	A
ComPact circuit breaker	
NS630b-1600	250
NS1600b-3200	300



Door interlock for ComPact NS630b to 1600

Mounted on the left or right-hand side of the chassis, this locking device prevents opening of the door if the circuit breaker is in the connected or test positions. If the circuit breaker was connected with the door open, the door may be closed without having to disconnect the circuit breaker.

B

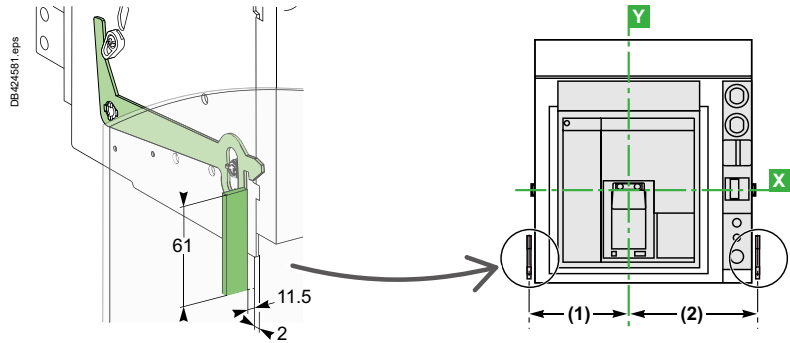

Dimensions (mm)		
Type	(1)	(2)
NS630b to 1600 (3P)	135	168
NS630b to 1600 (4P)	205	168

Device in the connected or test positions

Door locked

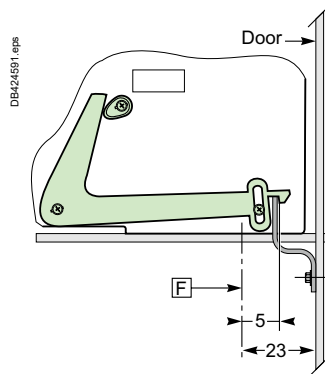

Device in the disconnected position

Door not locked

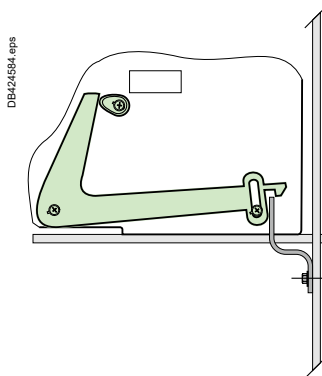

Note: The door interlock may be mounted on either the left or right-hand side of the chassis.

F Datum

Wiring of voltage releases

During pick-up, the power consumed is approximately 150 to 200 VA. For low control voltages (12, 24, 48 V), maximum cable lengths are imposed by the voltage and the cross-sectional area of cables.

Recommended maximum cable lengths (meter)						
		12 V		24 V		48 V
		2.5 mm ²	1.5 mm ²	2.5 mm ²	1.5 mm ²	2.5 mm ² 1.5 mm ²
MN	U source 100 %	–	–	58	35	280
	U source 85 %	–	–	16	10	75
MX-XF	U source 100 %	21	12	115	70	550
	U source 85 %	10	6	75	44	350

Note: the indicated length is that of each of the two wires.

24 V DC power-supply module

External 24 V DC power-supply module for Micrologic (F1-, F2+)

- It is recommended to use the AD power supply due to its low stray primary-secondary capacitance. Good operation of the Micrologic Trip Unit in noisy environment is not guaranteed with other power supplies.
- The dedicated AD power supplies shall be used only for the Micrologic trip units. If the COM option is used, a second dedicated power supply shall be used.
- The consumption of a Micrologic Trip Unit is approximately 100mA.
- For Micrologics control units alone, a number of 10 devices can be connected to the same AD power supply. Add other AD power supply for more than 10 Micrologics.
- If the installation is shared between several panels, one AD power supply shall be added for each panel.
- AD power supply dedicated to Micrologics trip units shall not be connected to earth. (F1-, F2+).

External 24 V DC power supply for Communication bus

- A dedicated 24 V DC power supply shall be used for the communication devices.
- Do not connect the positive terminal (E1) to earth.
- The negative terminal (E2) can be connected to earth.
- A number of communication modules (BCM, IFE, IFM, I/O, FDM...) can be connected to the same 24 V DC power supply. Refer below the devices consumption table to avoid exceeding the maximum current delivered by the 24 V DC power supply.

ULP module consumption

The table below lists the ULP module consumption.

Module	Typical Consumption (24 V DC at 20 °C / 68 °F)	Maximum Consumption (19.2 V DC at 60 °C / 140 °F)
BCM ULP for MasterPact and ComPact NS	40 mA	65 mA
Micrologic 5 or 6 trip unit for ComPact NSX circuit breakers	30 mA	55 mA
BSCM for ComPact NSX circuit breakers	9 mA	15 mA
2-wire RS 485 isolated repeater	15 mA	19 mA
FDM121 display for LV circuit breaker	21 mA	30 mA
IFM Modbus-SL interface for LV circuit breaker	21 mA	30 mA
IFE Ethernet interface for LV circuit breaker	120 mA	3 A (with gateway)
I/O input/output interface module for LV circuit breaker	165 mA	420 mA
Maintenance module	0 mA (the maintenance module has its own power supply)	0 mA (the maintenance module has its own power supply)

Installation recommendation

- The 24 V DC wires (output of the 24 V DC power supply) shall be twist together.
- The 24 V DC wires (output of the 24 V DC power supply) must cross all power cables perpendicularly.
- The technical characteristics of the external 24 V DC power-supply module for Micrologic control units are indicated on [page A-28](#).

Note: wiring of ZSI: it is recommended to use twisted shielded cable. The shield must be connected to earth at both ends.

Temperature derating

ComPact NS devices equipped with electronic trip units

ComPact circuit breakers have been tested for operation in industrial atmospheres. It is recommended that the equipment be cooled or heated to the proper operating temperature and kept free of excessive vibration and dust.

ComPact NS630b to NS1600 [1]

The table below indicates the maximum rated-current value for each type of connection, depending on the ambient temperature. For mixed connections, use the same derating values as for horizontal connections.

Version	Fixed device															
	Connection	Front or horizontal rear							Vertical rear							
		temp. Ti [2]	40	45	50	55	60	65	70	40	45	50	55	60	65	70
NS630b N/L	630	630	630	630	630	630	630	630	630	630	630	630	630	630	630	630
NS800 N/L	800	800	800	800	800	800	800	800	800	800	800	800	800	800	800	800
NS1000 N/L	1000	1000	1000	1000	1000	1000	1000	1000	1000	1000	1000	1000	1000	1000	1000	1000
NS1250 N	1250	1250	1250	1250	1250	1240	1090	1250	1250	1250	1250	1250	1250	1250	1180	
NS1600 N	1600	1600	1560	1510	1470	1420	1360	1600	1600	1600	1600	1600	1600	1510	1460	

Version	Withdrawable device															
	Connection	Front or horizontal rear							Vertical rear							
		temp. Ti [2]	40	45	50	55	60	65	70	40	45	50	55	60	65	70
NS630b N/L	630	630	630	630	630	630	630	630	630	630	630	630	630	630	630	630
NS800 N/L	800	800	800	800	800	800	800	800	800	800	800	800	800	800	800	800
NS1000 N/L	1000	1000	1000	1000	1000	1000	920	1000	1000	1000	1000	1000	1000	1000	990	
NS1250 N	1250	1250	1250	1250	1250	1170	1000	1250	1250	1250	1250	1250	1250	1250	1090	
NS1600 N	1600	1600	1520	1480	1430	1330	1160	1600	1600	1600	1560	1510	1420	1250		

ComPact NS1600b to 3200

Version	Fixed device															
	Connection	Front or horizontal rear							Vertical rear							
		temp. Ti [2]	40	45	50	55	60	65	70	40	45	50	55	60	65	70
NS1600b N	1600	1600	1600	1600	1500	1450	1400	1600	1600	1600	1600	1600	1600	1550	1500	
NS2000 N	2000	2000	2000	2000	1900	1800	1700	2000	2000	2000	2000	2000	2000	1900	1800	
NS2500 N	2500	2500	2500	2500	2500	2500	2500	2500	2500	2500	2500	2500	2500	2500	2500	
NS3200 N	-	-	-	-	-	-	-	3200	3200	3200	3180	3080	2970	2860		

[1] For a circuit breaker mounted in horizontal position, the derating to be applied is equivalent to that of a front or horizontal rear connected circuit breaker.

[2] Ti: temperature around the circuit breaker and its connections.

Power dissipation / Resistance

ComPact NS devices equipped with electronic trip units

The values indicated in the tables opposite are typical values.

Power dissipated per pole (P/pole) in Watts (W)

The value indicated in the table is the power dissipated at I_N , 50/60 Hz, for a three-pole or four-pole circuit breaker (these values can be higher than the power calculated on the basis of the pole resistance). Measurement and calculation of the dissipated power are carried out in compliance with the recommendations of Annex G of standard IEC 60947-2.

Resistance per pole (R/pole) in milliohms (mΩ)

The value of the resistance per pole is provided as a general indication for a new device.

The value of the contact resistance must be determined on the basis of the measured voltage drop, in accordance with the manufacturer's test procedure (expert card ABT no. FE 05e).

Note: this measurement is not sufficient to determine the quality of the contacts, i.e. the capacity of the circuit breaker to carry its rated current.

ComPact NS630b to 1600

Version	Fixed device					
	N		L		LB	
	R/pole	P/pole	R/pole	P/pole	R/pole	P/pole
NS630b	0.026	10	0.039	15	0.056	15
NS800	0.026	15	0.039	20	0.056	20
NS1000	0.026	22	0.039	34		
NS1250	0.026	44				
NS1600	0.026	74				

Version	Withdrawable device					
	N		L		LB	
	R/pole	P/pole	R/pole	P/pole	R/pole	P/pole
NS630b	0.038	19	0.072	34	0.086	34
NS800	0.038	30	0.072	40	0.086	40
NS1000	0.038	50	0.072	77		
NS1250	0.036	84				
NS1600	0.036	154				

ComPact NS1600b to 3200

Version	Fixed device	
	R/pole	P/pole
NS1600b	0.019	84
NS2000	0.013	84
NS2500	0.008	100
NS3200	0.008	227



Dimensions and connection

ComPact NS630b to 1600 (fixed version)	
Dimensions	C-2
Mounting	C-3
Front-panel cutouts	C-4
Rotary handle.....	C-5
ComPact NS630b to 1600 (withdrawable version)	
Dimensions, mounting and cutouts.....	C-6
Rotary handle.....	C-7
ComPact NS1600b to 3200 (fixed version)	
Dimensions	C-8
ComPact NS630b to 3200	
External modules	C-9
FDM121 switchboard display	C-13
FDM128 switchboard display	C-14
Accessories NS630b to 3200	C-15
ComPact NS630b to 1600 (fixed version)	
Bars	C-16
Cables with lugs and bare cables.....	C-19
ComPact NS630b to 1600 (withdrawable versions)	
Bars	C-20
Cables with lugs.....	C-22
ComPact NS1600b to 3200 (fixed version).....	
C-23	
Power connections for ComPact NS630b to 1600	
Recommended drilling dimensions.....	C-24
Power connections for ComPact NS1600b to 3200	
Recommended drilling dimensions.....	C-25
Power connections for ComPact NS630b to 3200	
C-26	
Sizing of bars	C-28

ComPact NS630b to 1600 (fixed version)

Dimensions

Manual control

Front connection (N, L)

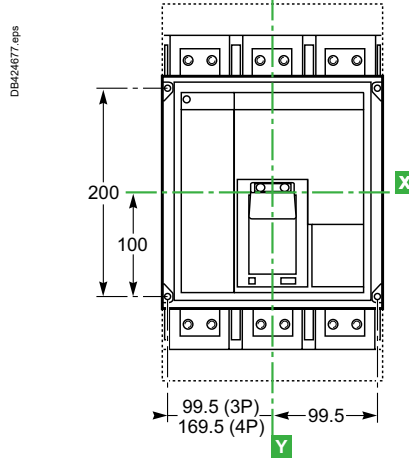
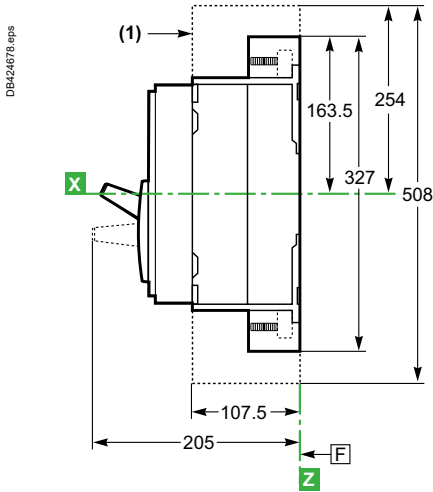

[1] Terminal shields are optional.

Rear connection (N, L, LB)

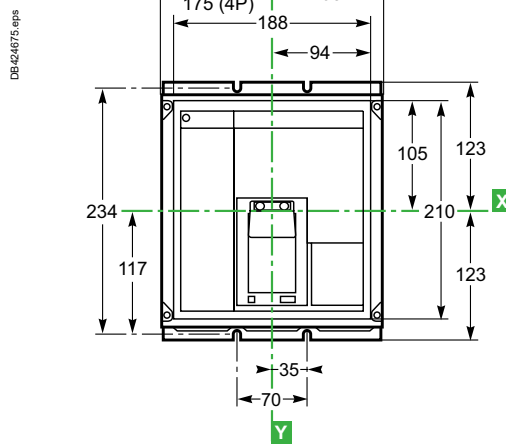
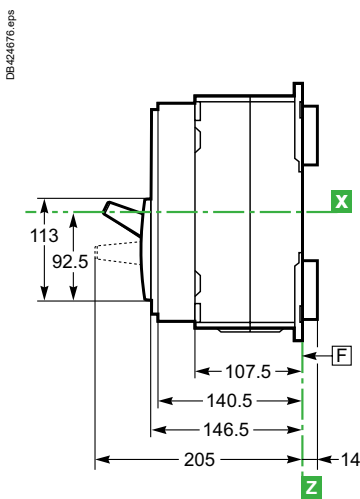

Electrical control

Front and rear connection (N, L, LB)

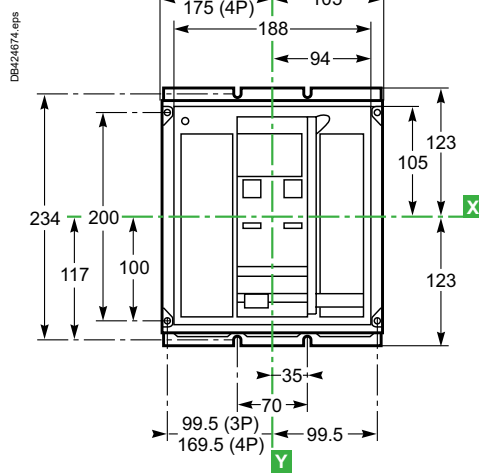
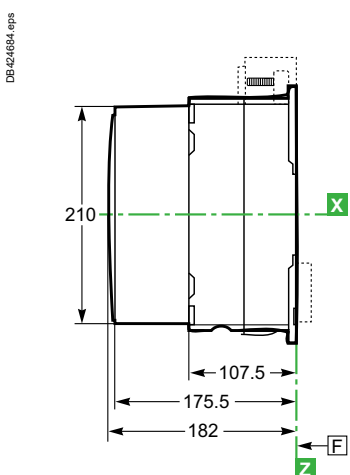

[F] : Datum.

Note: Dimensions for front and rear connection on electrically operated devices are identical to those for manually operated devices.

Dimensions and connection

ComPact NS630b to 1600 (fixed version)

Mounting

Front connection

On backplate

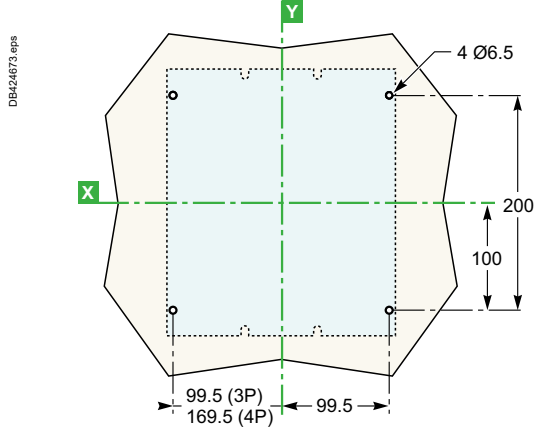

On rails

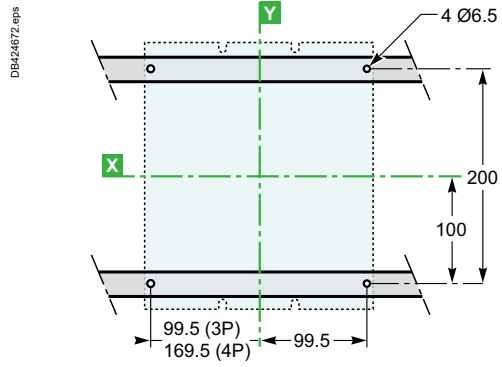

Rear connection

On backplate

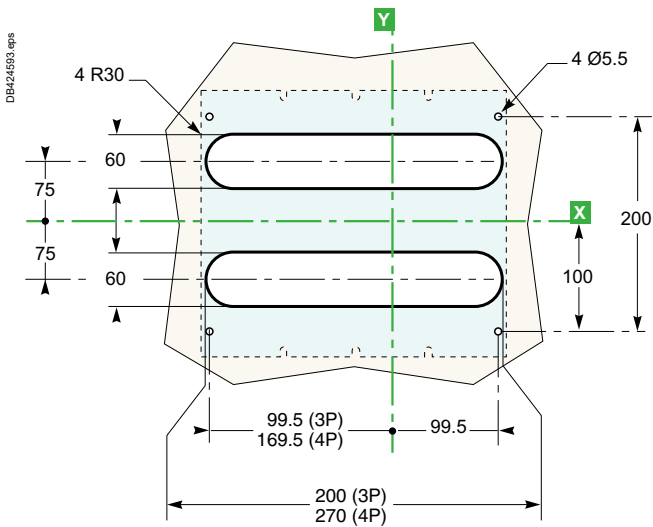

On rails

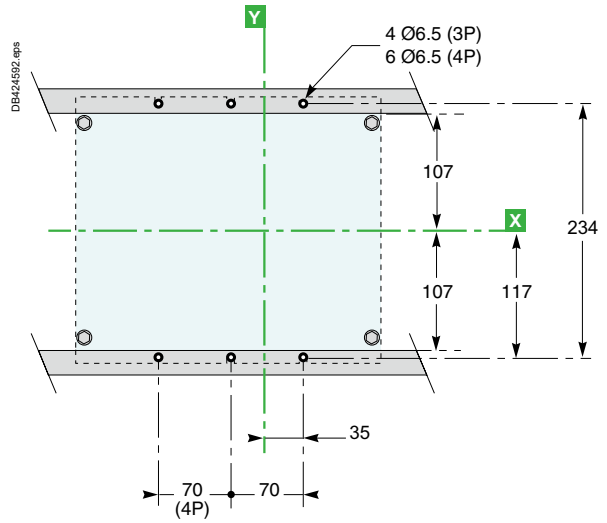

Note: Mounting parameters for electrically operated devices are identical to those for manually operated devices.

X and Y are the symmetry planes for a 3-pole device

Z is the back plane of the device.

ComPact NS630b to 1600 (fixed version)

Front-panel cutouts

Toggle control

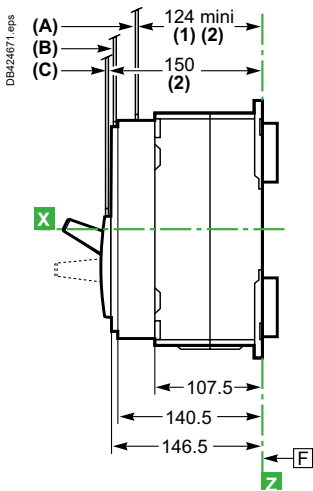

F : Datum.
[1] Without escutcheon.
[2] With escutcheon.

Door cutout

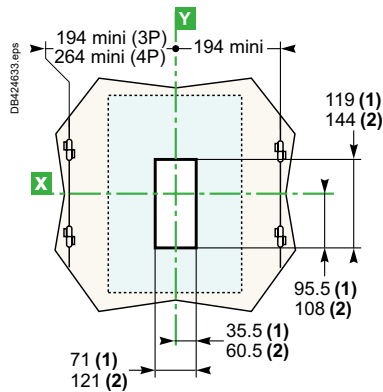
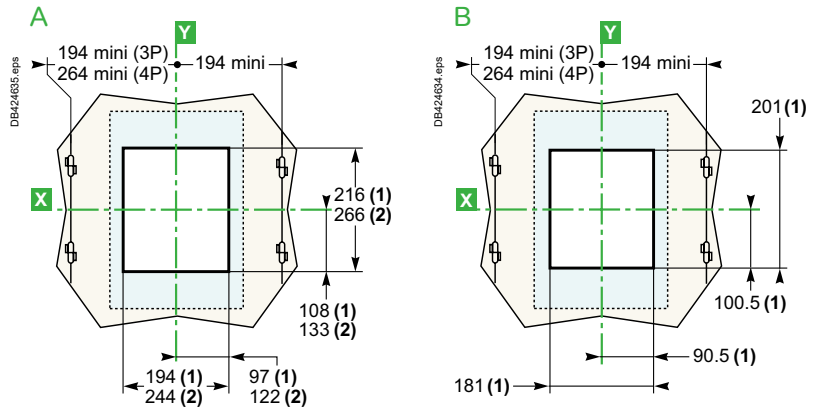

Electrical control

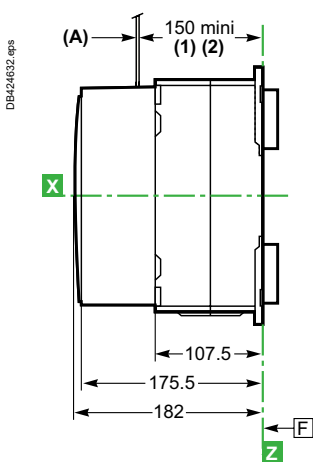

F : Datum.
[1] Without escutcheon.
[2] With escutcheon.

Door cutout A

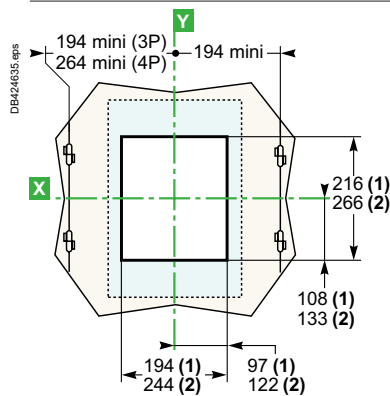

ComPact NS630b to 1600 (fixed version) Rotary handle

Direct rotary handle

Dimensions

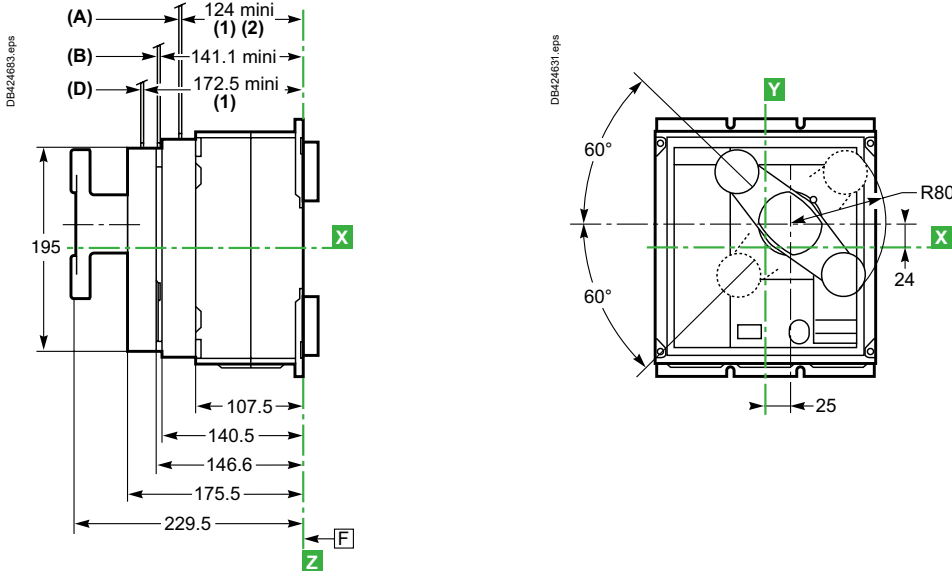

Door cutout

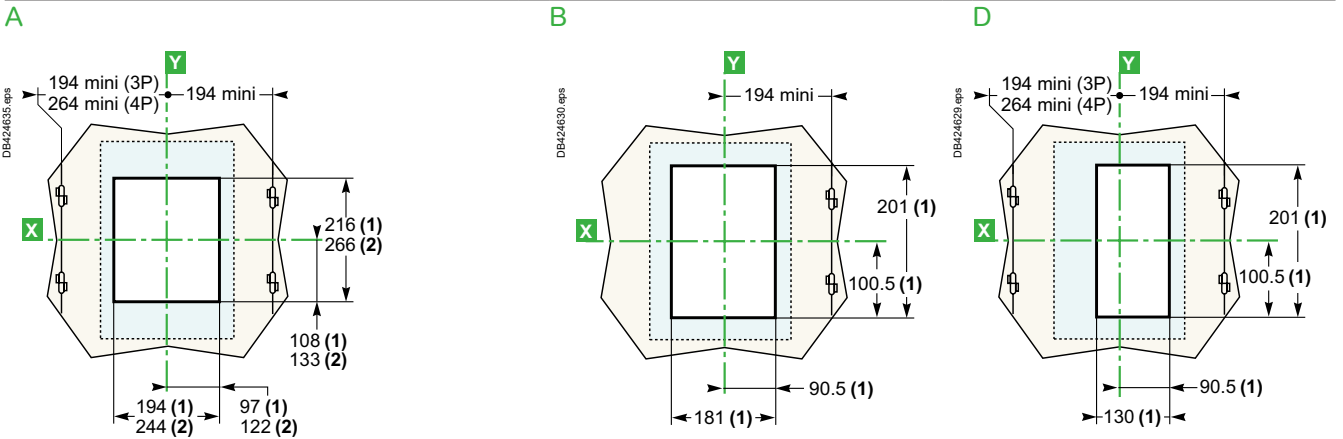

- [1] Without escutcheon.
- [2] With escutcheon.

Extended rotary handle

Dimensions

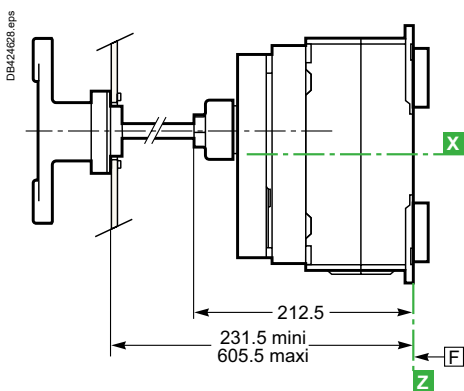

Door cutout

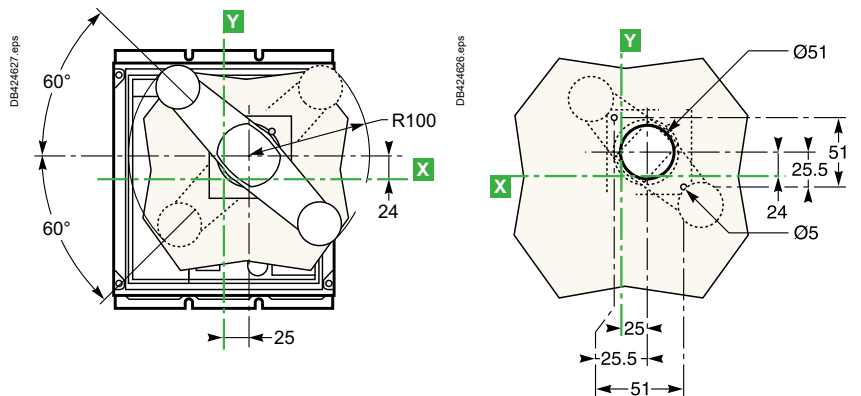

[F] : Datum.

Note: X and Y are the symmetry planes for a 3-pole device Z is the back plane of the device.

ComPact NS630b to 1600 (withdrawable version)

Dimensions, mounting and cutouts

Dimensions

Manual control

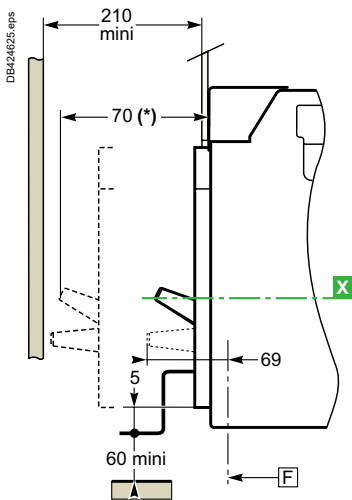

Electrical control

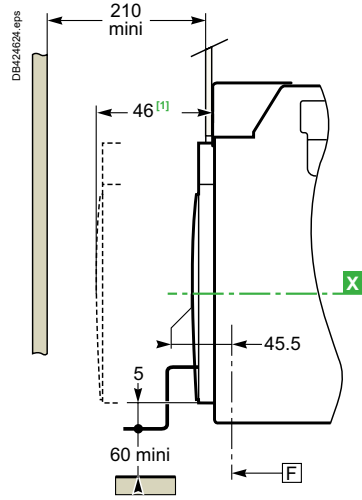

[1] Withdrawable position

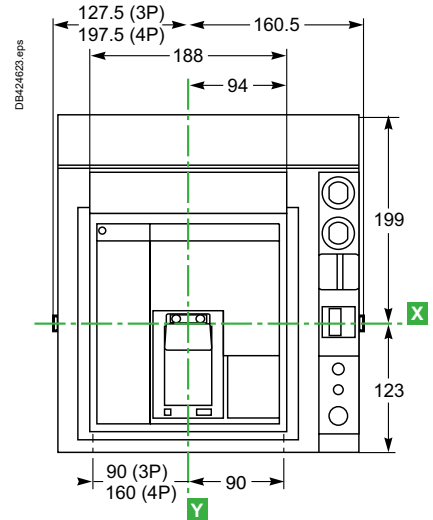

Mounting

Bottom mounting on base plate or rails

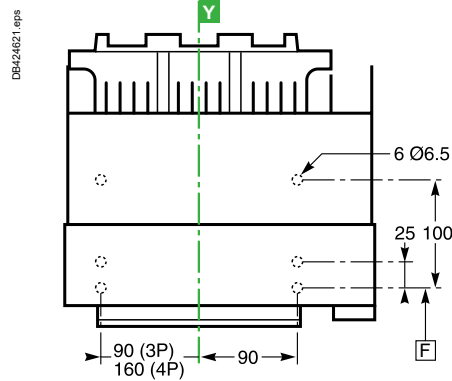
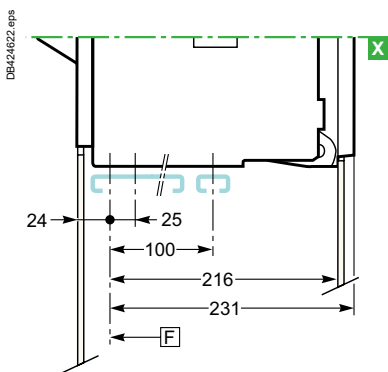

Vertical on uprights or backplate

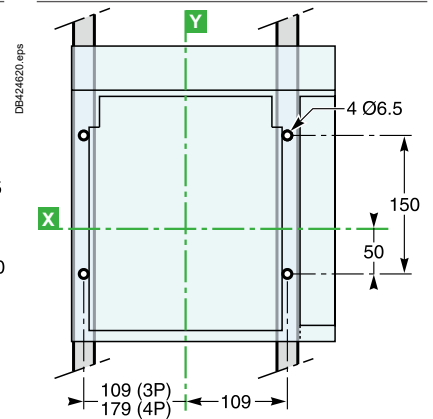

Cutouts

Door cutout

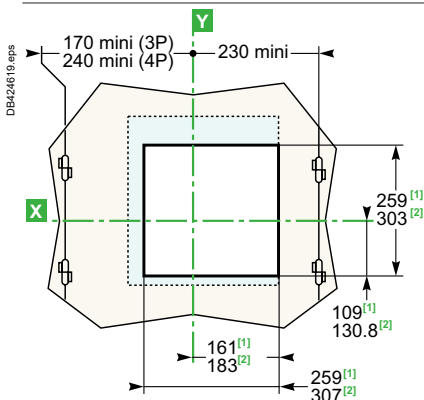

Rear panel cutout

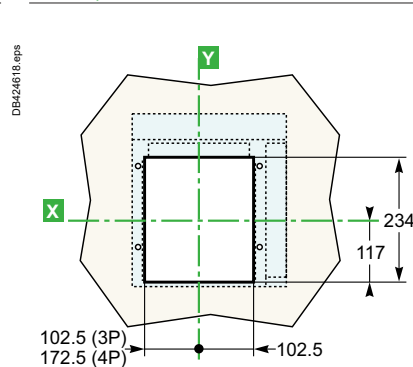

[1] Without escutcheon.

[2] With escutcheon.

F : Datum.

Note: X and Y are the symmetry planes for a 3-pole device.

ComPact NS630b to 1600 (withdrawable version)

Rotary handle

Direct rotary handle

Dimensions

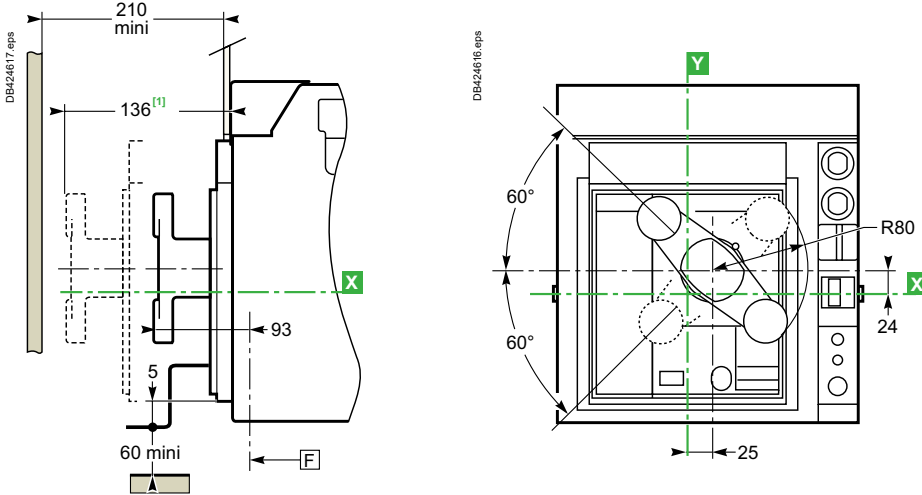

[1] Withdrawable position.

Door cutout

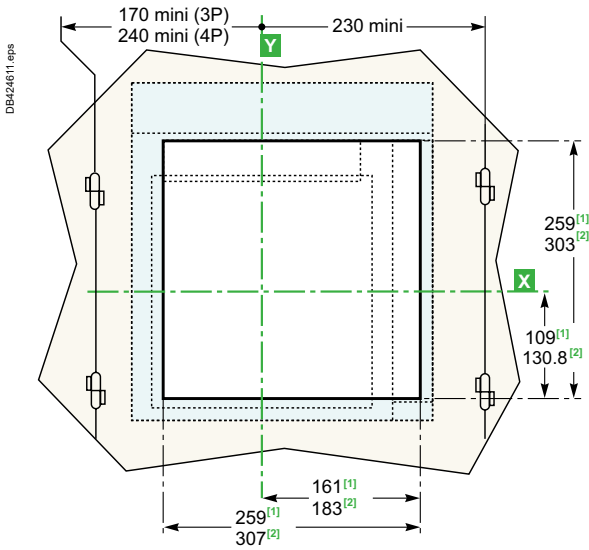

[1] Without escutcheon.
[2] With escutcheon.

Extended rotary handle

Dimensions

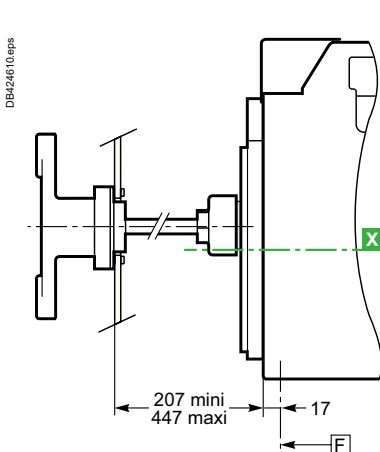

Door cutout

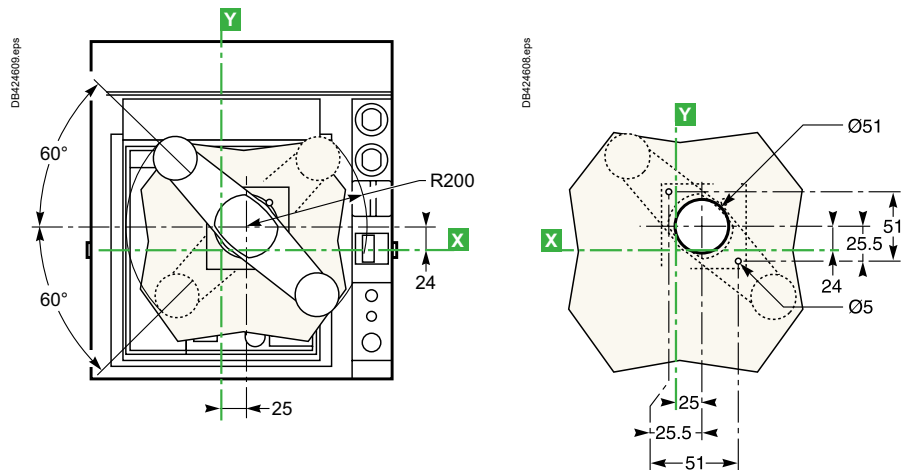

Note: X and Y are the symmetry planes for a 3-pole device.

ComPact NS1600b to 3200 (fixed version)

Dimensions

Dimensions

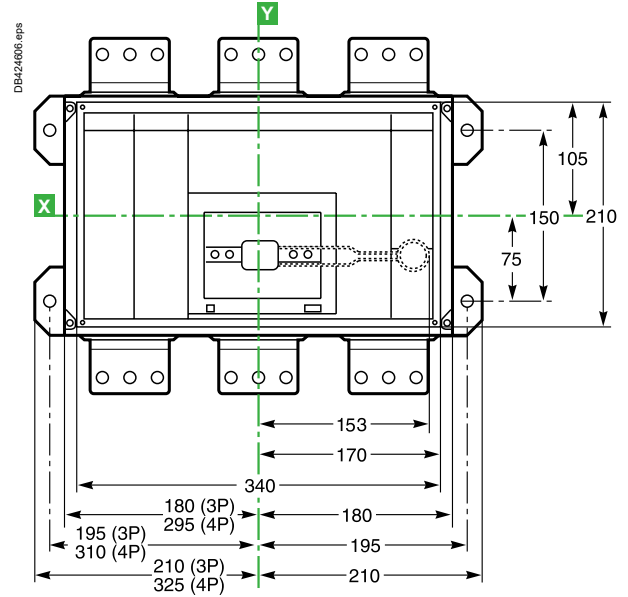
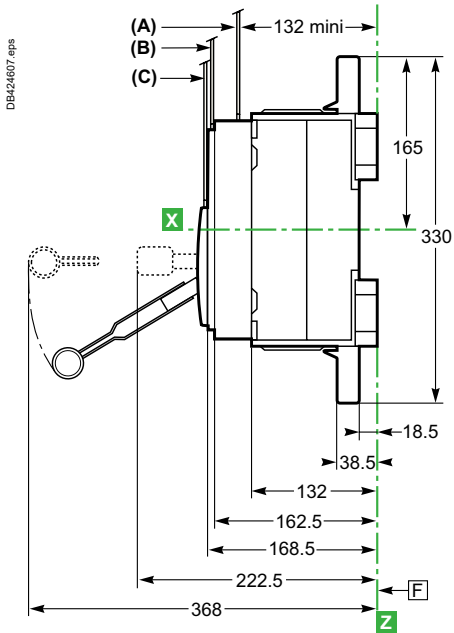

Door cutout (A, B, C)

A

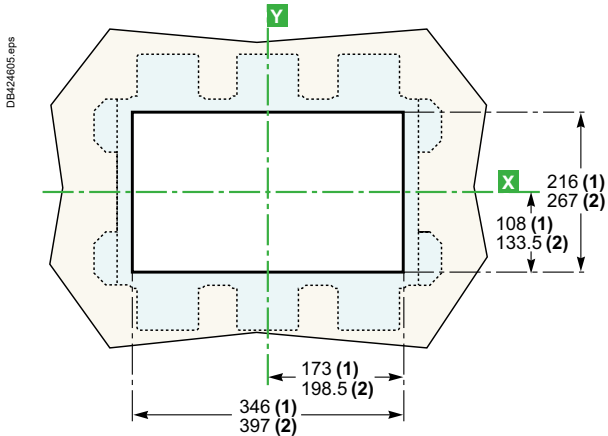

B

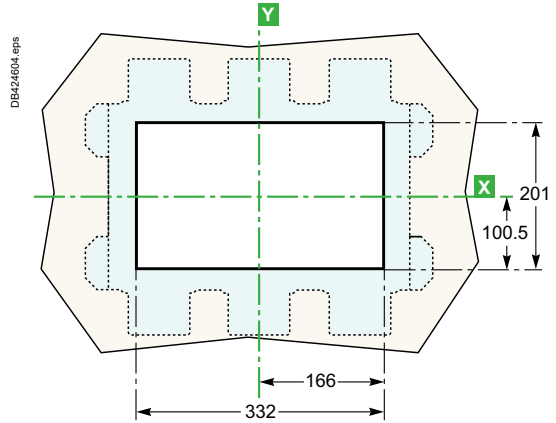

C

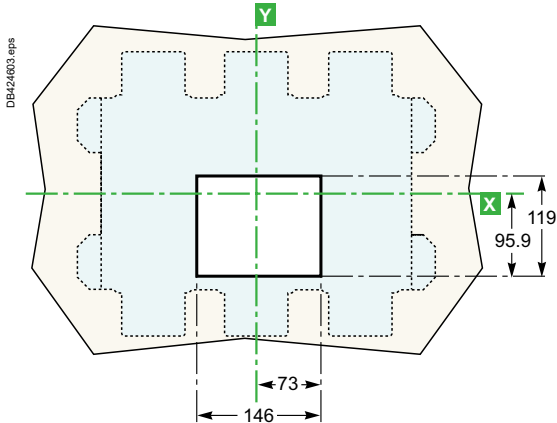

Mounting on rails

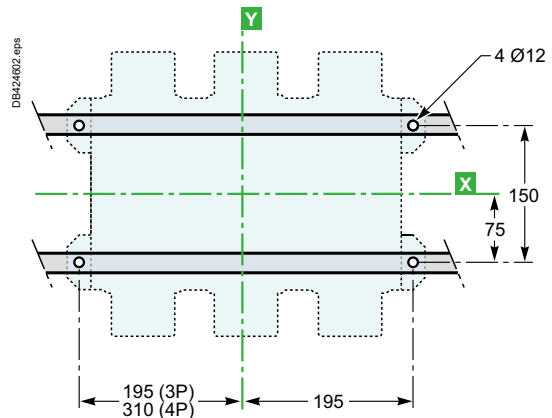

F : Datum.

(1) Without escutcheon.

(2) With escutcheon.

C-8

Life Is On

Schneider Electric

Note: **X** and **Y** are the symmetry planes for a 3-pole device.

Dimensions and connection

ComPact NS630b to 3200

External modules

Control-wire connections to terminal block

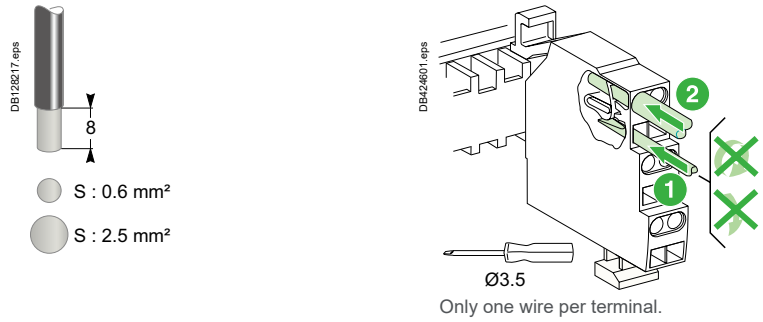

External power-supply module (AD)

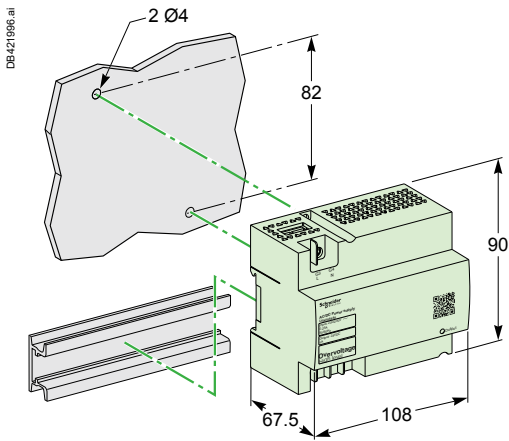

Battery module (BAT)

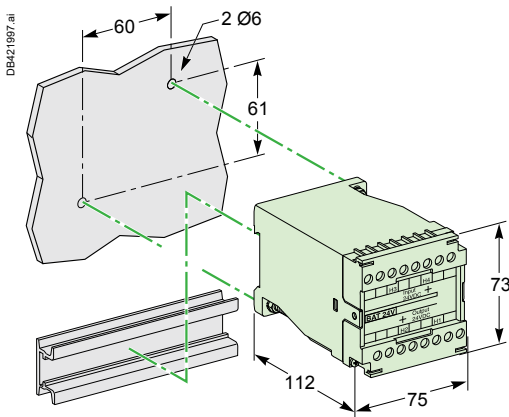

Chassis communication module

Modbus

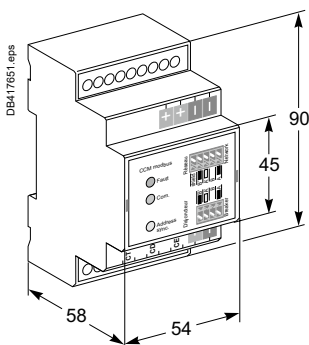

Dimensions and connection

ComPact NS630b to 3200

External modules

I/O (Input/Output) application module

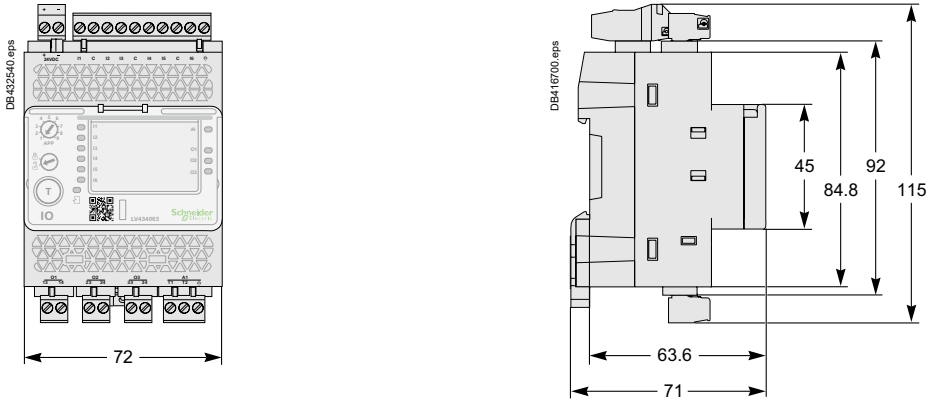

IFM - Modbus-SL interface

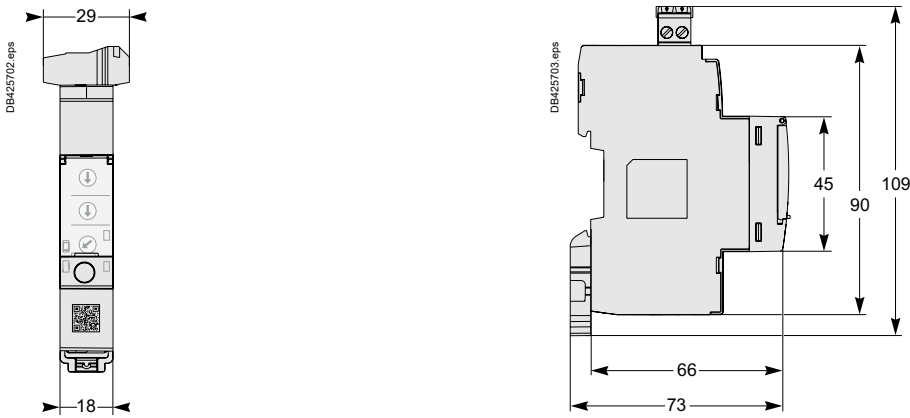

IFE - Ethernet interface

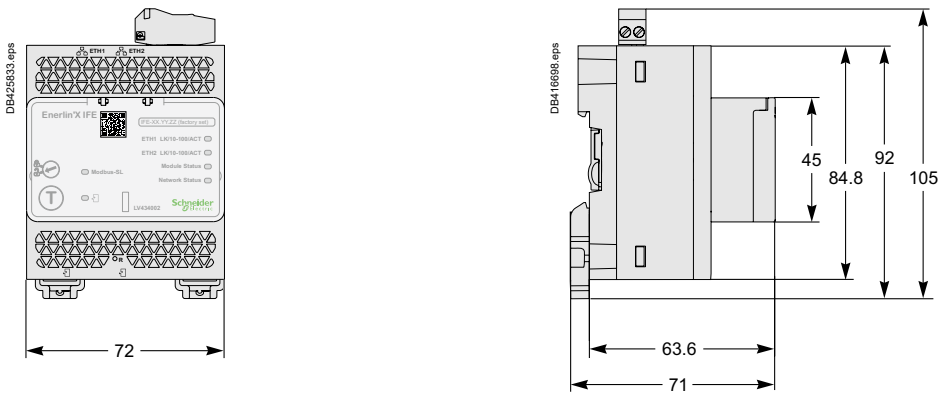

Com'X 210/510

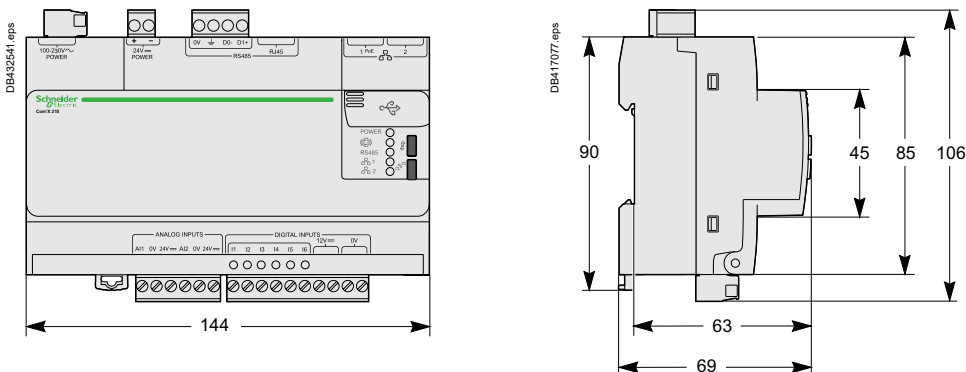

External sensor for neutral

400/1600 A (NS630b to 1600)

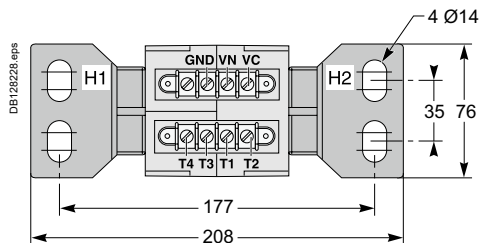

1000/4000 A (NS1600b to 3200)

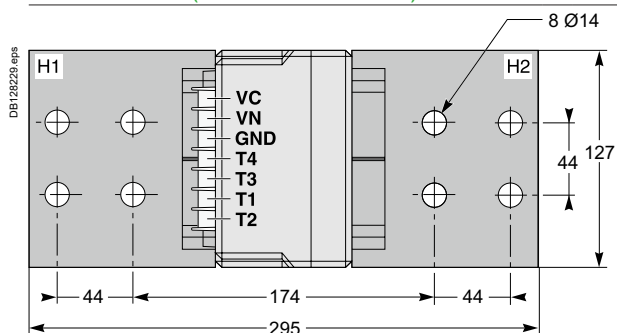

Installation

400/1600 (NS630b to NS1600)

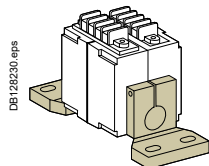

1000/4000 A (NS1600b to NS3200)

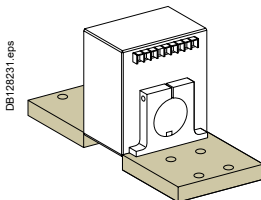

ComPact NS630b to 3200

External modules

Rectangular sensor for earth leakage protection (Vigi)

280 x 115 mm window

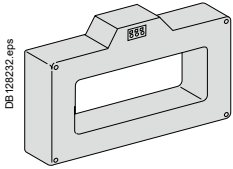

DB128232.eps

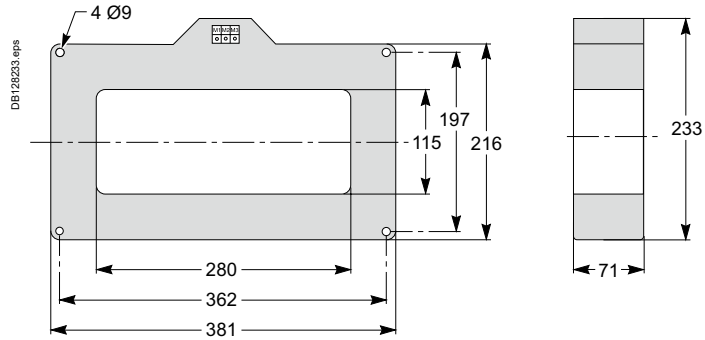

470 x 160 mm window

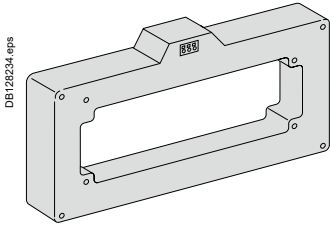

DB128234.eps

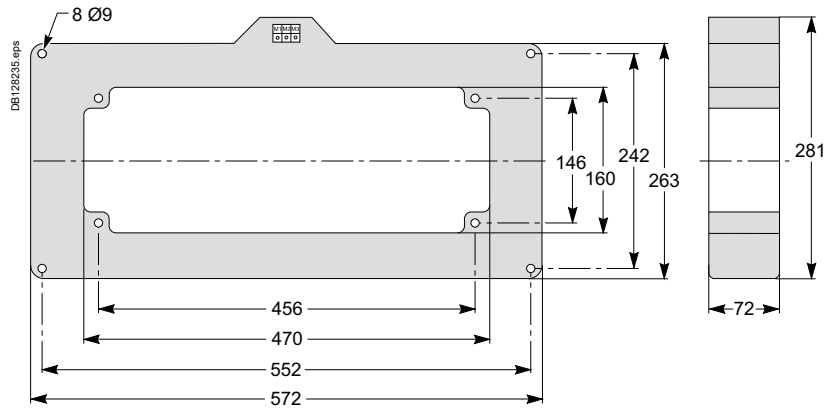

Busbars	I ≤ 1600 A	I ≤ 3200 A
Window (mm)	280 x 115	470 x 160
Weight (kg)	14	18

Busbars path

280 x 115 mm window Busbars spaced 70 mm centre-to-centre

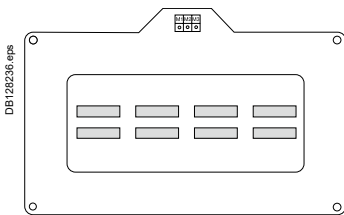

DB128236.eps

2 bars 50 x 10

470 x 160 mm window Busbars spaced 115 mm centre-to-centre

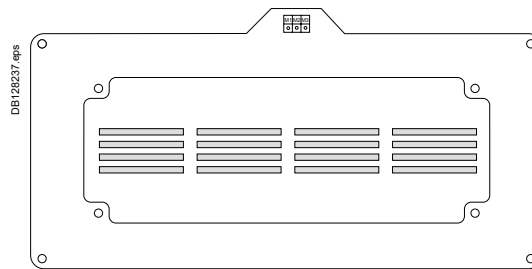

DB128237.eps

4 bars 100 x 5

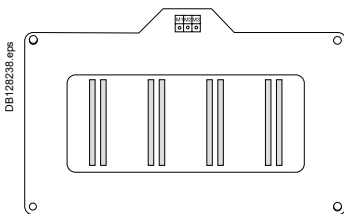

DB128238.eps

2 bars 100 x 5

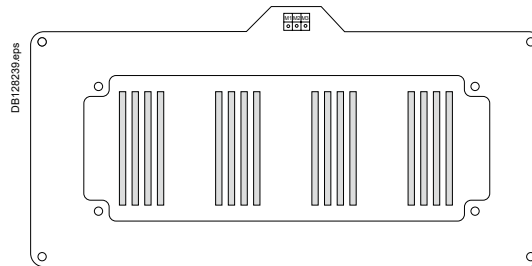

DB128239.eps

4 bars 125 x 5

Dimensions

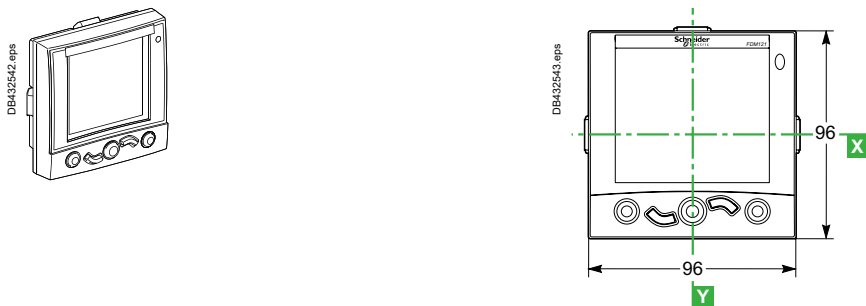

Mounting

Through panel

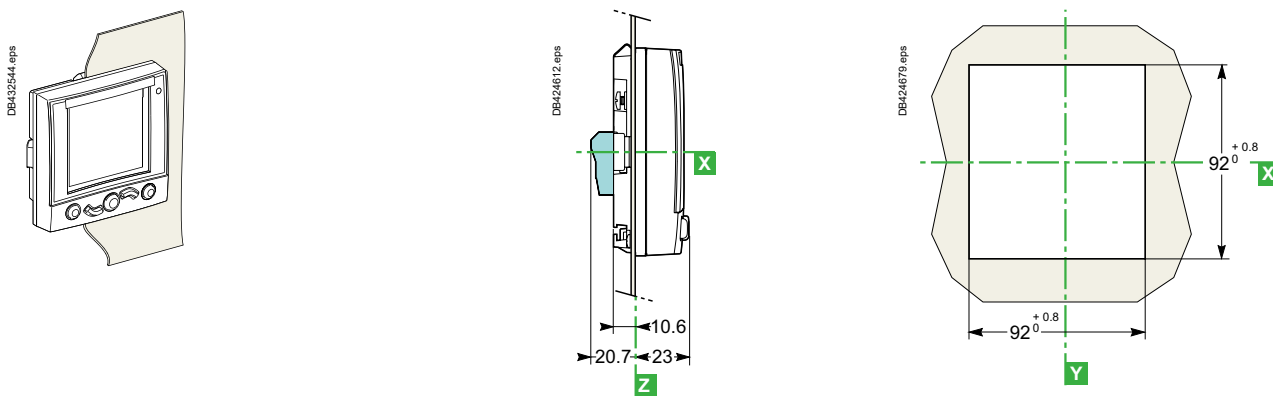

On panel

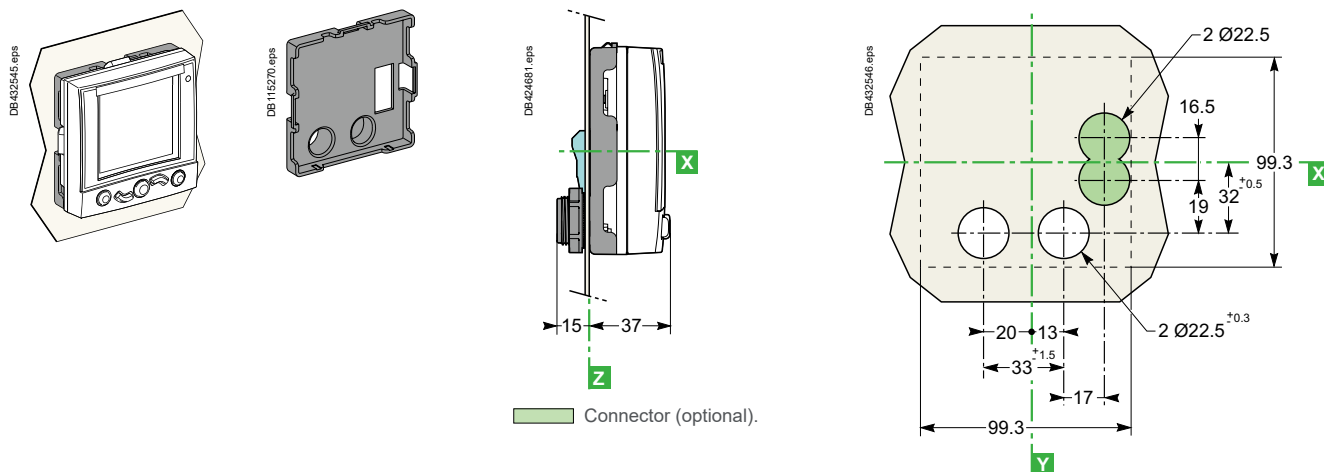

FDM128 switchboard display

Dimensions

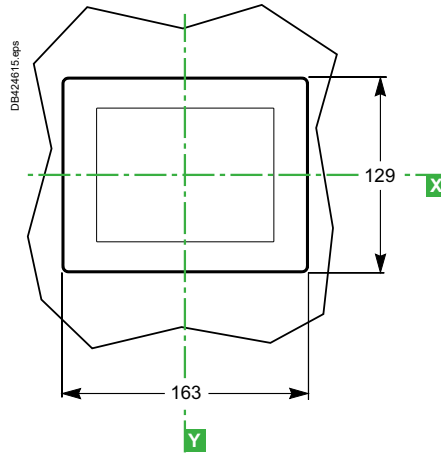
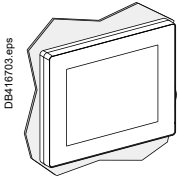

Mounting

On panel

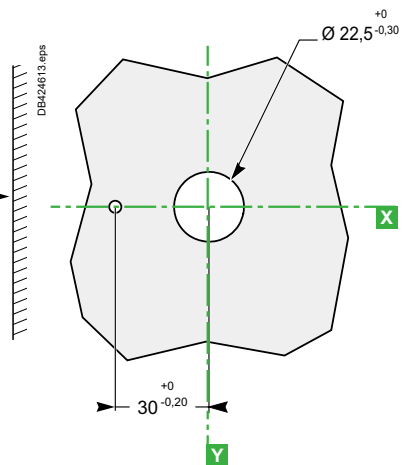
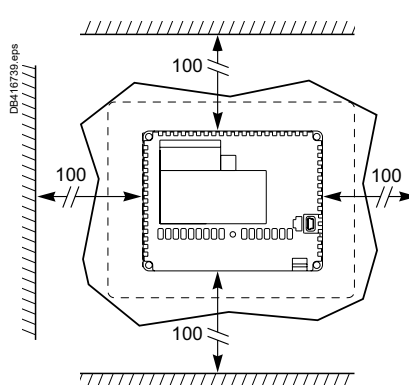
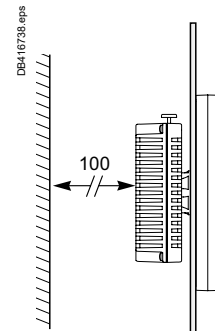
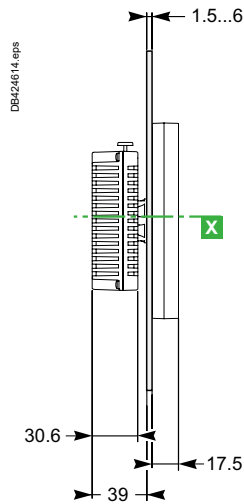
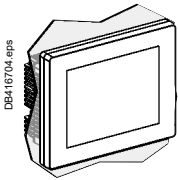

Escutcheon

NS630b to NS1600 (fixed control)

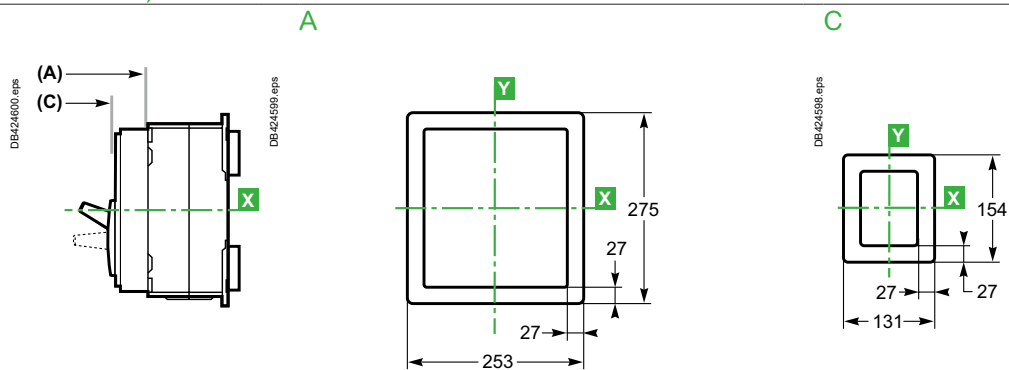

NS630b to NS1600 (withdrawable control)

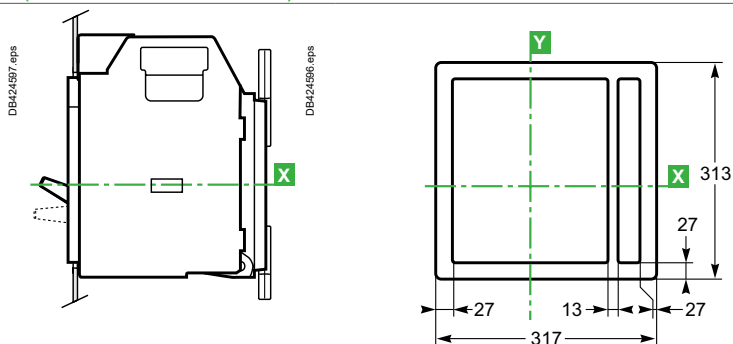

NS1600b to NS3200 (fixed control)

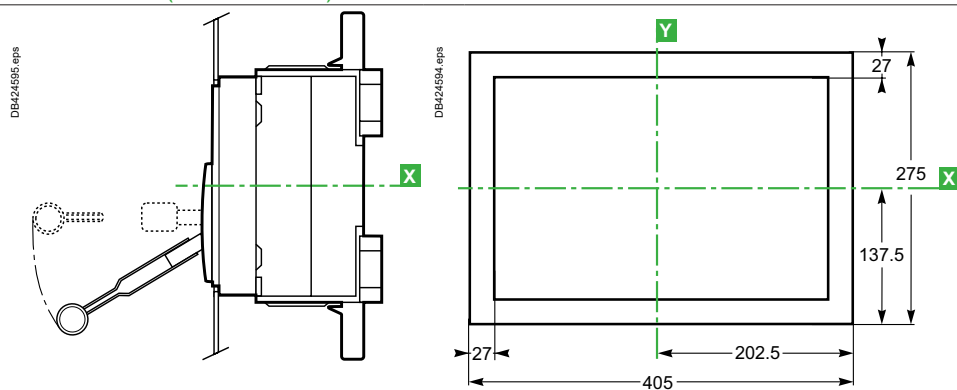

ComPact NS630b to 1600 (fixed version) Bars

Horizontal rear connection

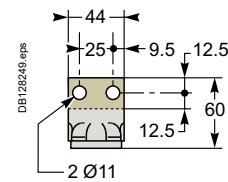
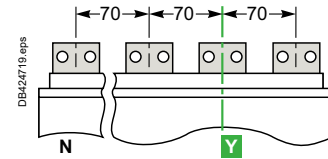
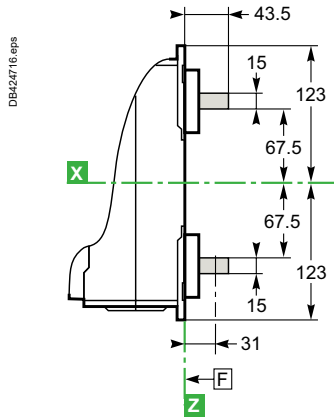
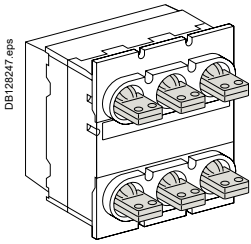

Vertical rear connection

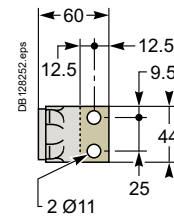
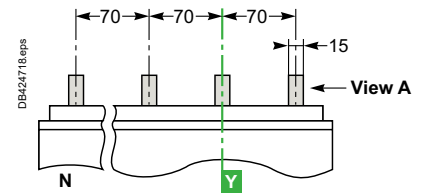
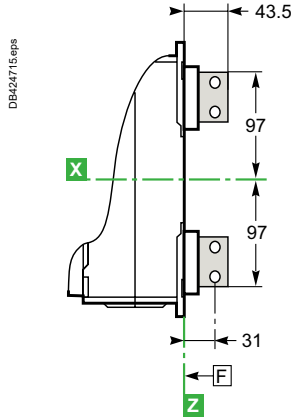
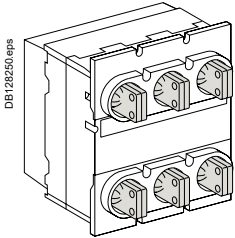

View A detail.

Front connection

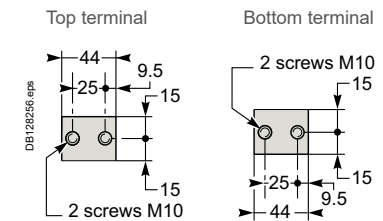
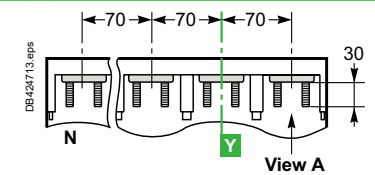
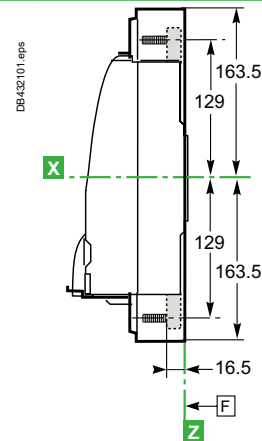
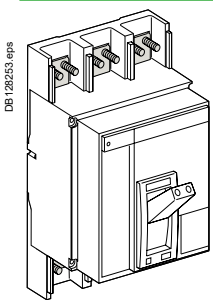

View A detail.

F: Datum.

Note: Recommended connection screws: M10 class 8.8. Tightening torque: 50 Nm with contact washer.

Dimensions and connection

ComCompact NS630b to 1600 (fixed version)

Bars

Front connection with spreaders

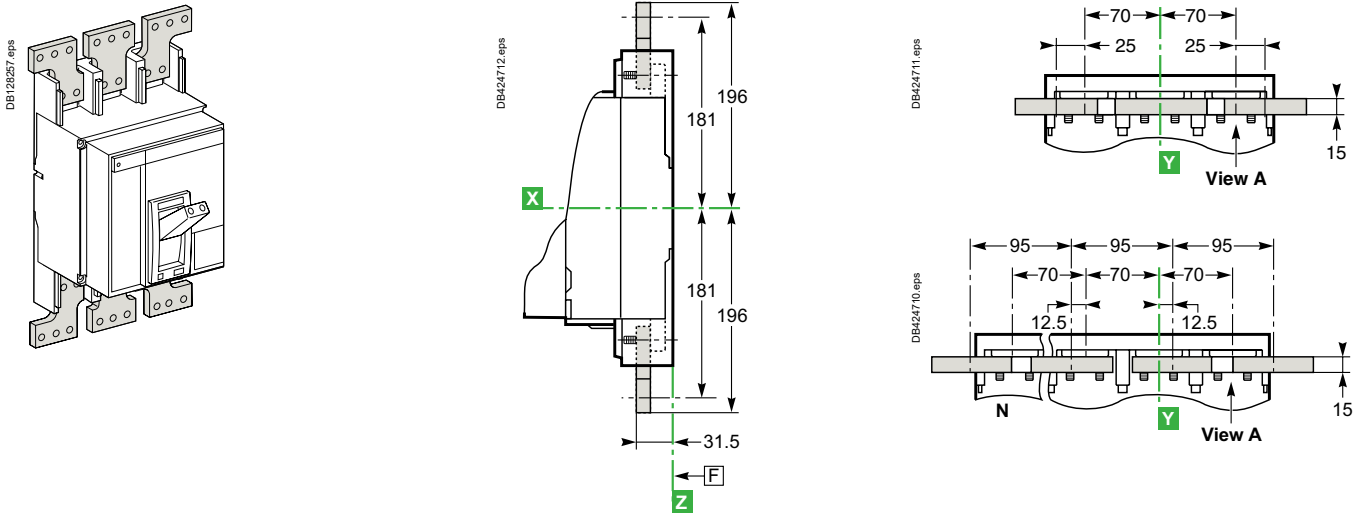

Rear connection with spreaders

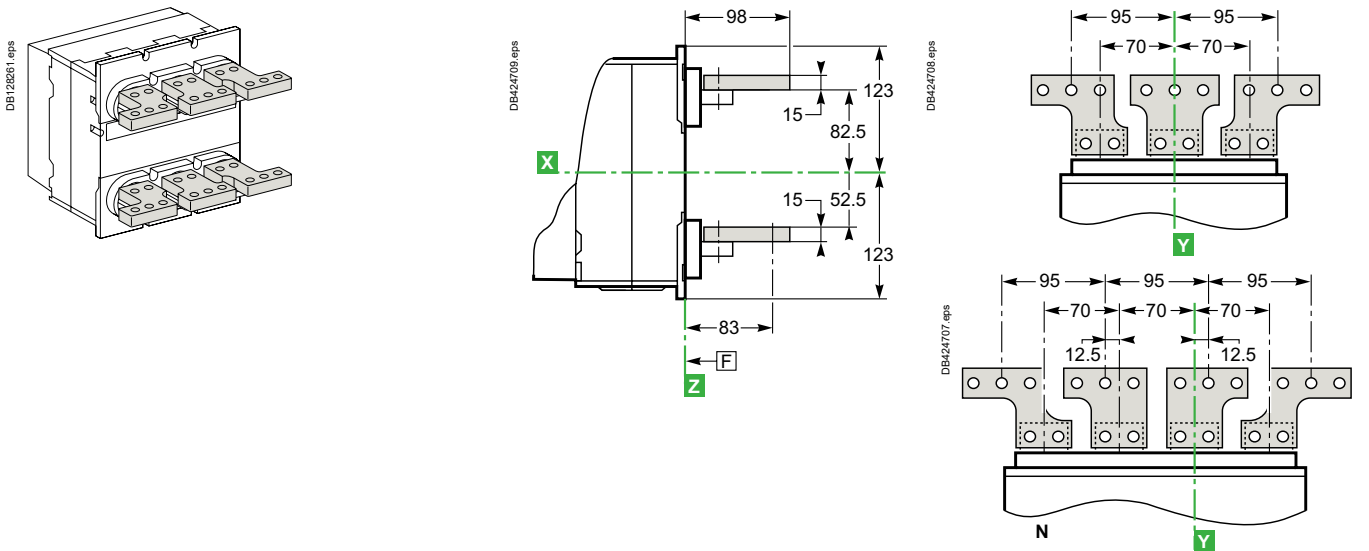

Spreader detail

Middle left or middle right spreader for 4P

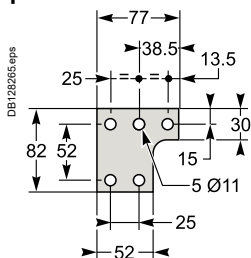

Middle spreader for 3P

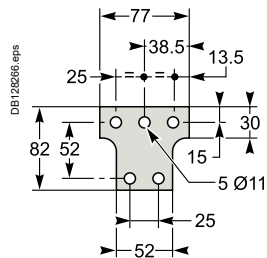

Left or right spreader for 4P

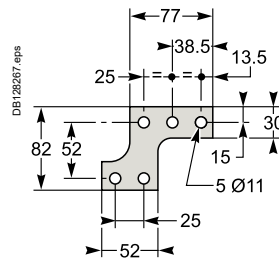

Left or right spreader for 3P

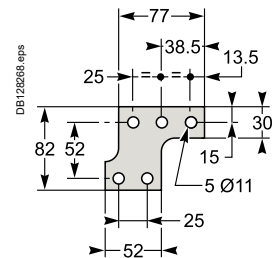

View A detail.

F : Datum.

Note: **X** and **Y** are the symmetry planes for a 3-pole device.

ComPact NS630b to 1600 (fixed version) Bars

Front connection with vertical-connection adapters

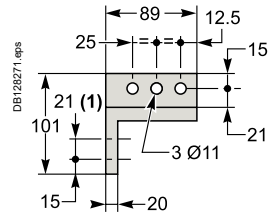
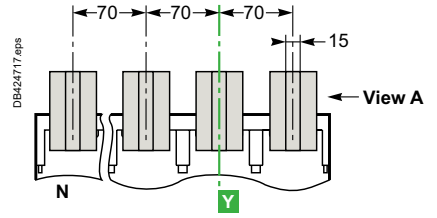
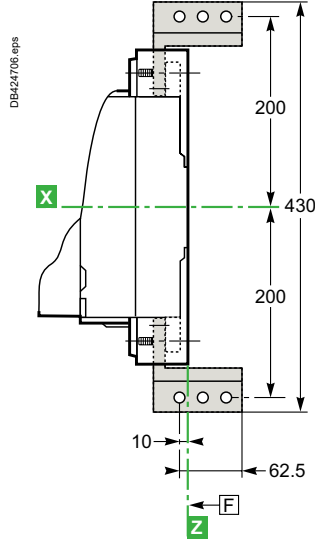
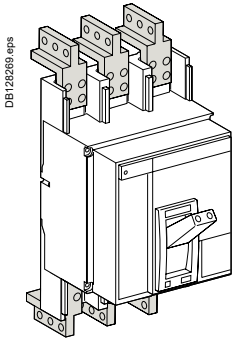

View A detail.

F: Datum.

Note: [1] two mounting possibilities for vertical-connection adapters (pitch 21 mm).
Recommended connection screws: **M10** class 8.8.
Tightening torque: **50 Nm** with contact washer.

ComPact NS630b to 1600 (fixed version)

Cables with lugs and bare cables

Front connection with vertical-connection adapters and cable-lug adapters

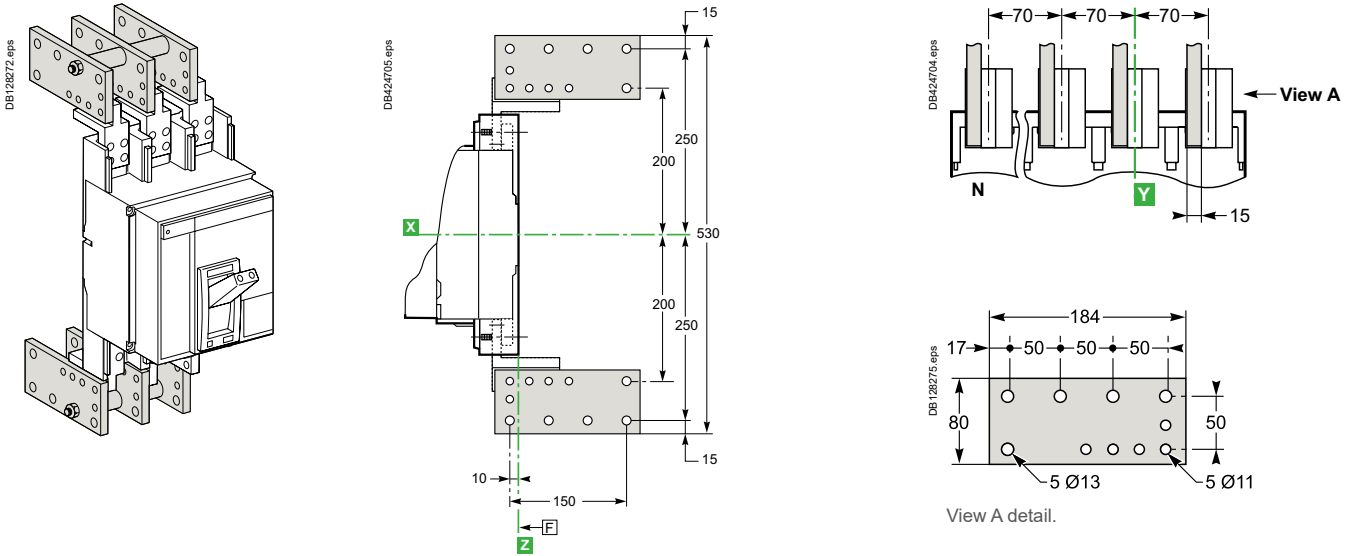

Lugs

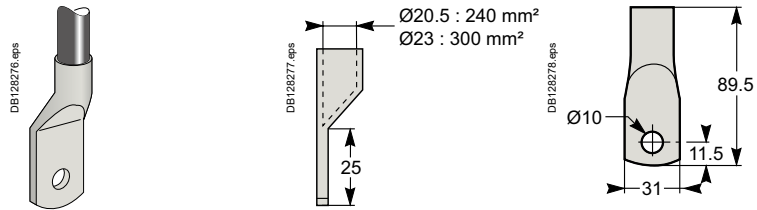

Fixed circuit breaker with 4-cable bare-cable connectors (240 mm²)

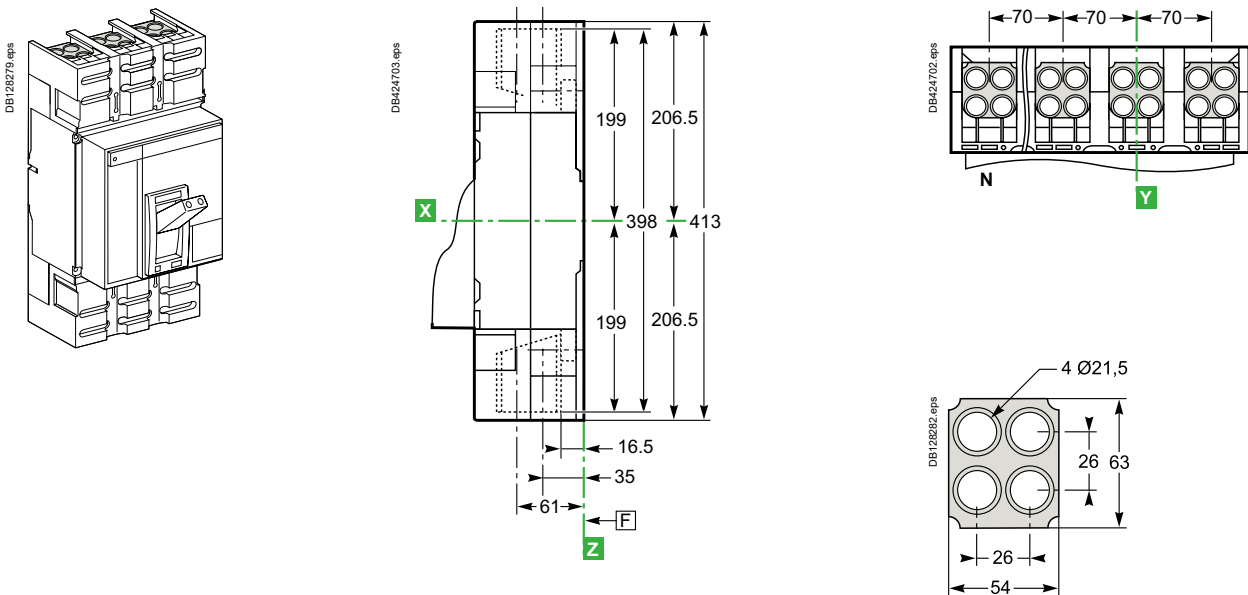

F : Datum.

ComPact NS630b to 1600 (withdrawable versions) Bars

Horizontal rear connection

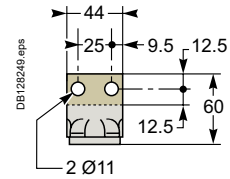
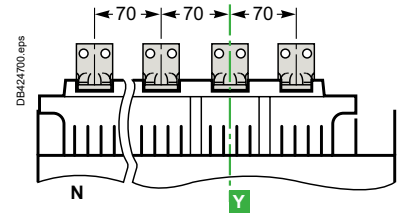
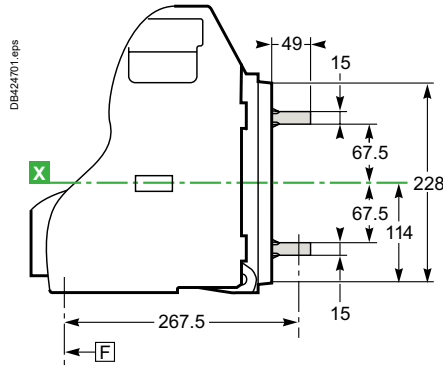
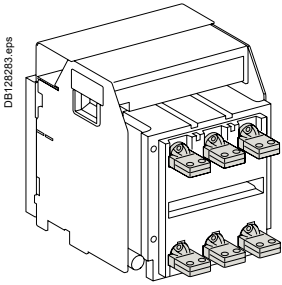

Vertical rear connection

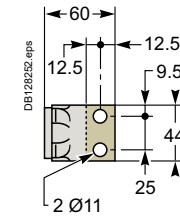
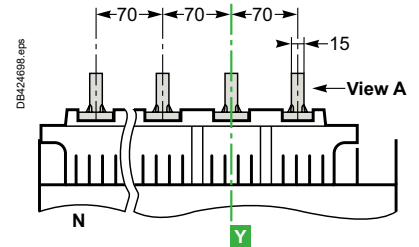
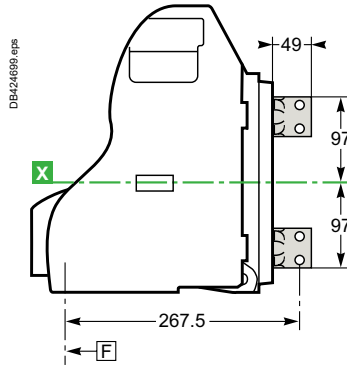
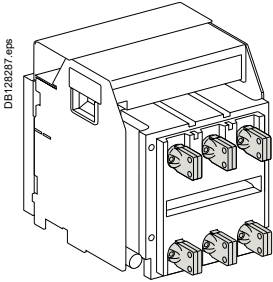

View A detail.

Front connection

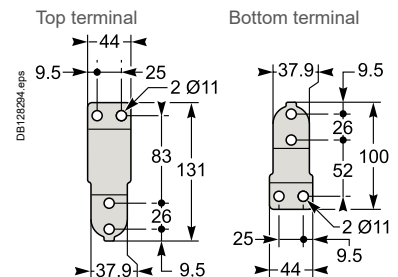
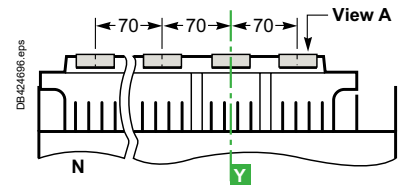
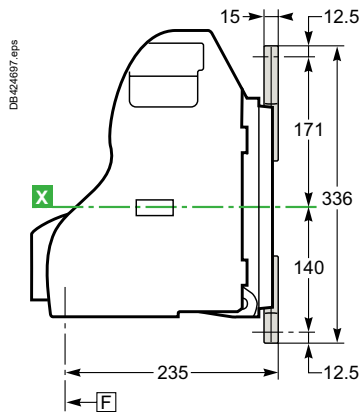
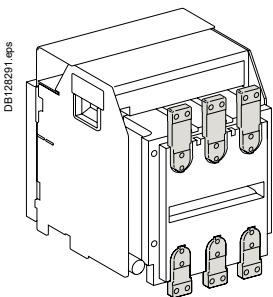

View A detail.

F: Datum.

Note: Recommended connection screws: M10 class 8.8. Tightening torque: 50 Nm with contact washer.

ComPact NS630b to 1600 (withdrawable versions) Bars

Front connection with spreaders

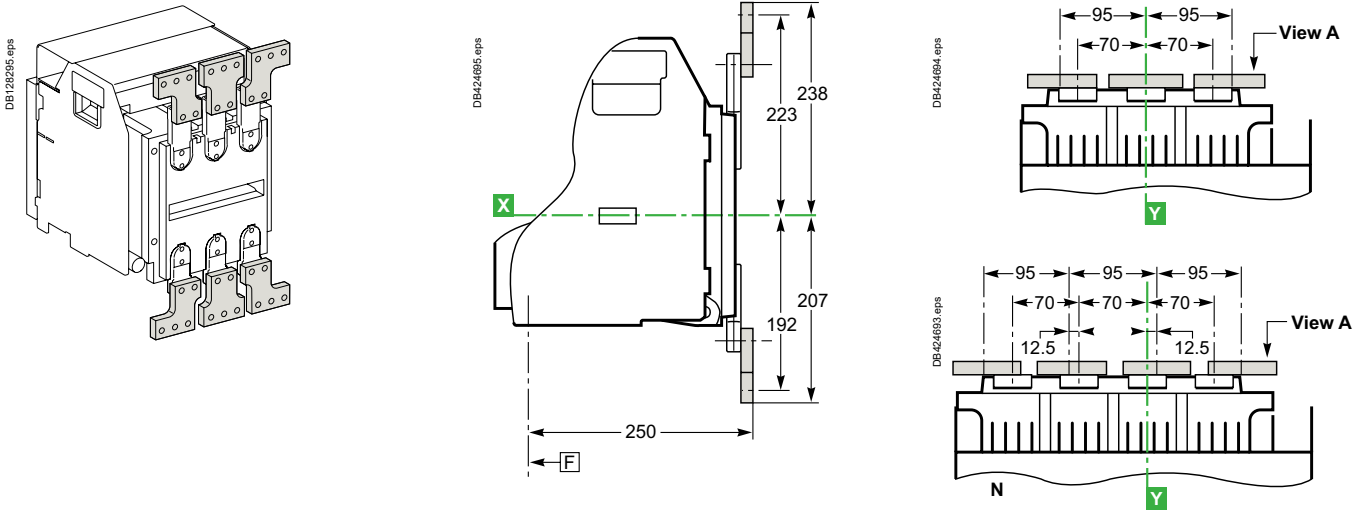

Spreader detail

Middle left or middle right spreader for 4P

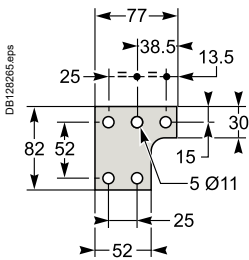

Middle spreader for 3P

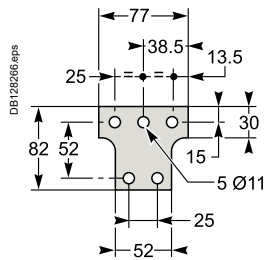

Left or right spreader for 4P

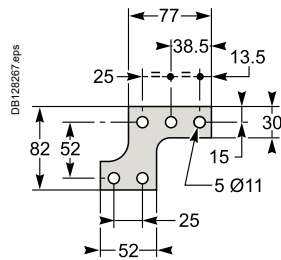

Left or right spreader for 3P

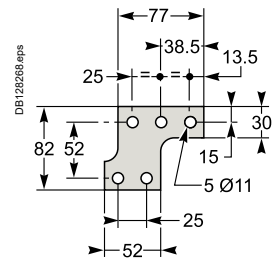

View A detail.

F: Datum.



ComPact NS630b to 1600 (withdrawable versions)

Cables with lugs

Front connection with vertical-connection adapters and cable-lug adapters

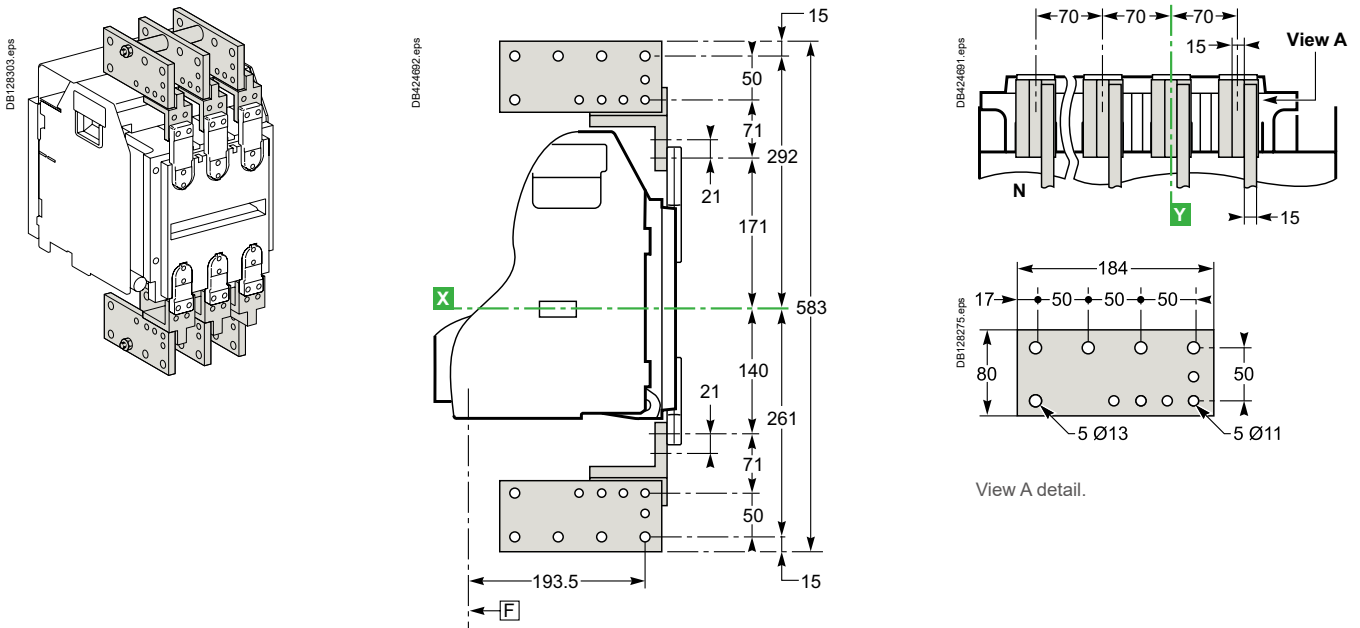

Lugs

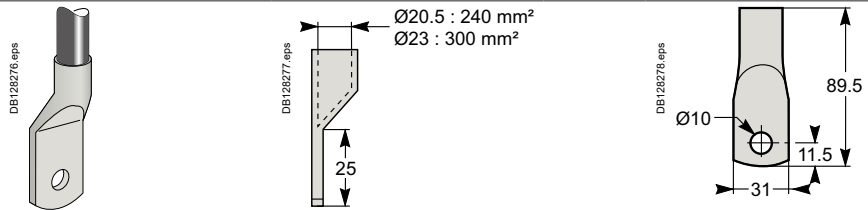

F: Datum.

Note: **X** and **Y** are the symmetry planes for a 3-pole device.

Recommended connection screws: **M10** class 8.8.

Tightening torque: **50 Nm** with contact washer.

Dimensions and connection

ComCompact NS1600b to 3200 (fixed version)

Front connection (NS1600b to 2500)

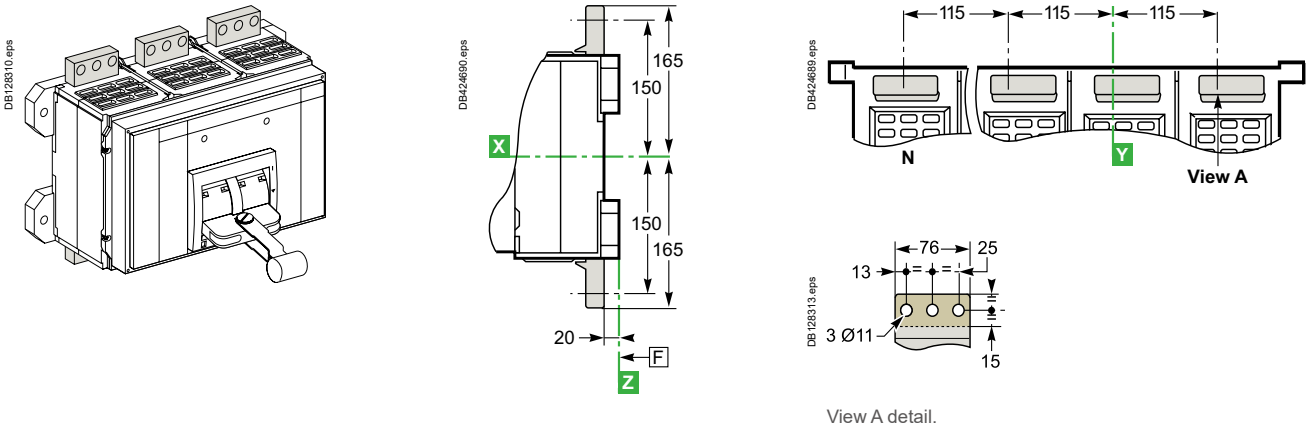

Front connection with vertical-connection adapters (NS1600b to 2500)

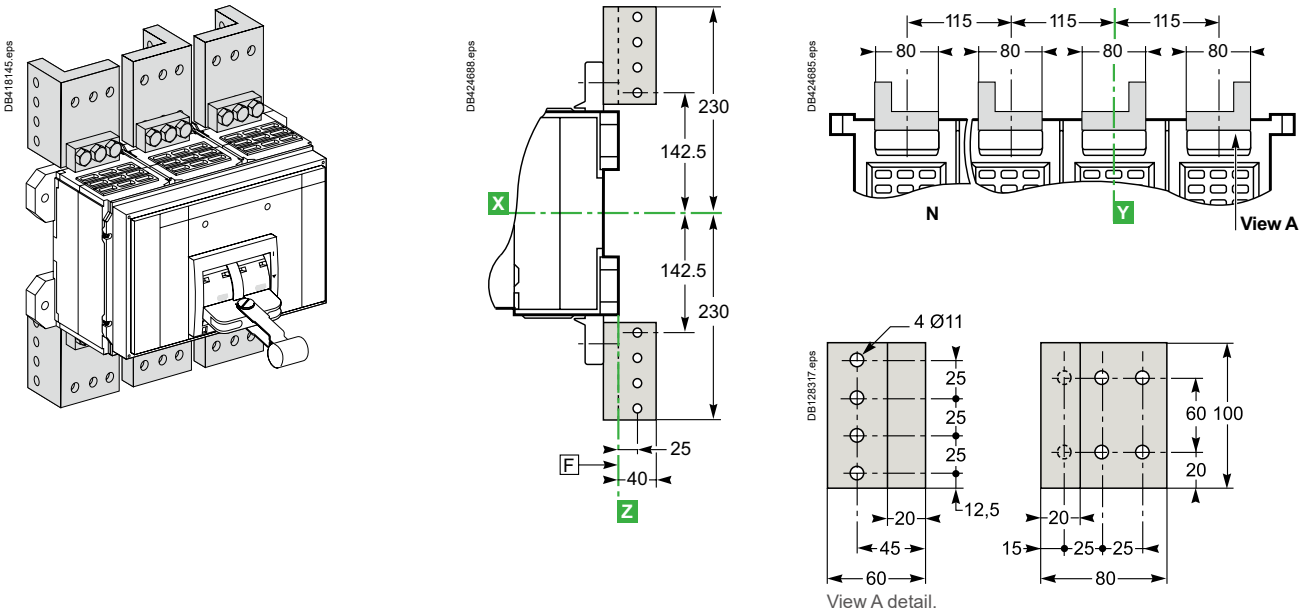

Front connection (NS3200)

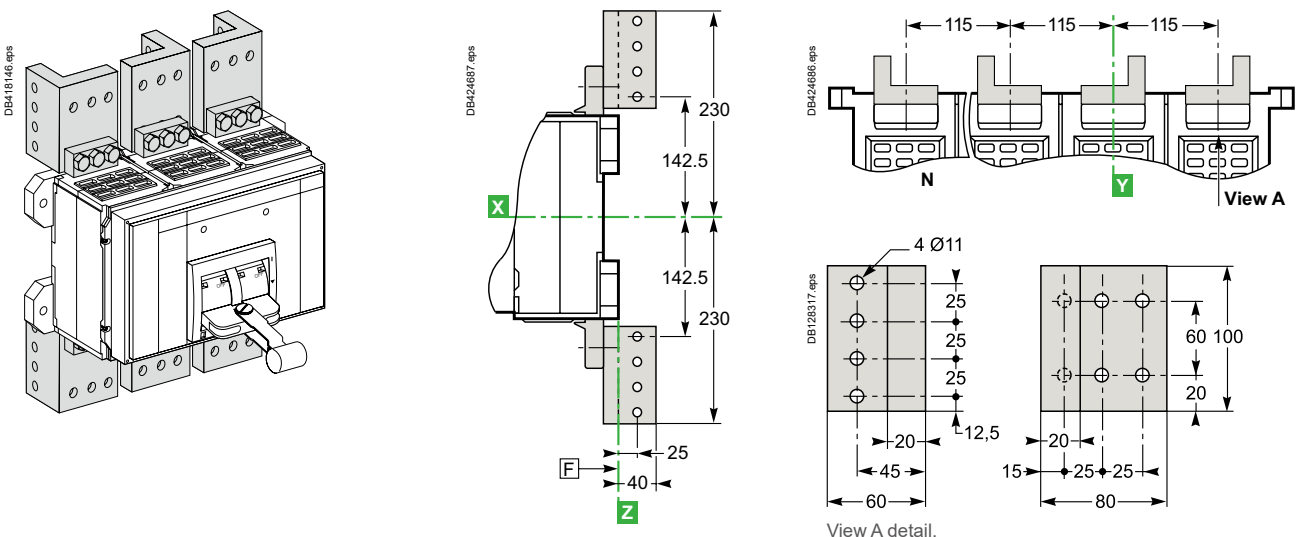

F : Datum.

Note: Recommended connection screws: **M10** class 8.8.
Tightening torque: **50 Nm** with contact washer.

Power connections for ComPact NS630b to 1600

Recommended drilling dimensions

Rear connection

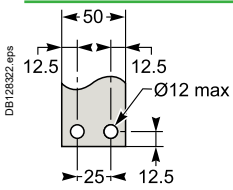

Rear connection with spreaders

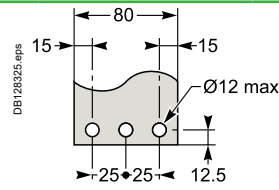
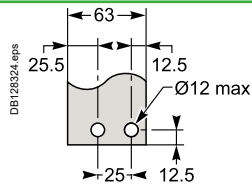
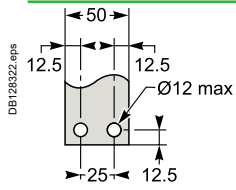

Middle left or middle right spreader for 4P

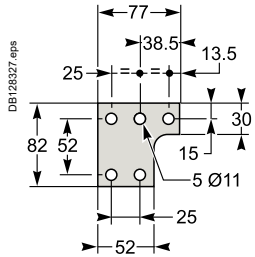
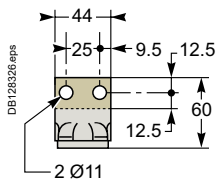

Middle spreader for 3P

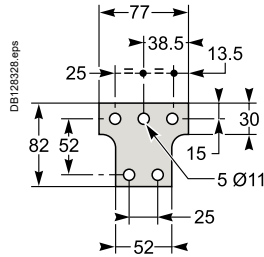

Left or right spreader for 4P

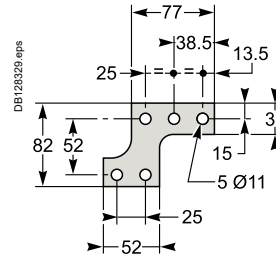

Left or right spreader for 3P

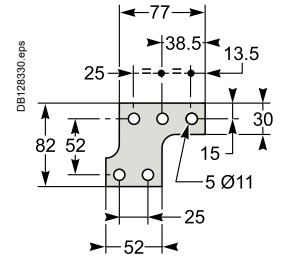

Vertical rear connection

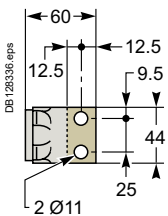
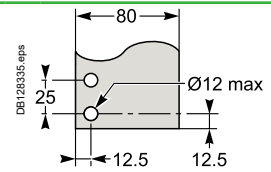
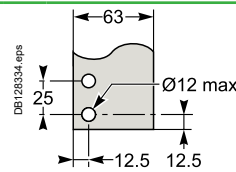
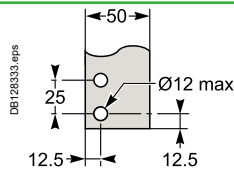
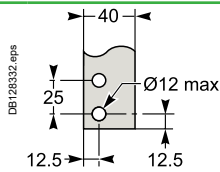
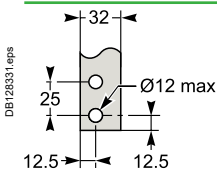

Front connection

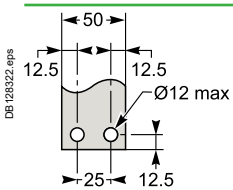

Front connection with vertical-connection adapter

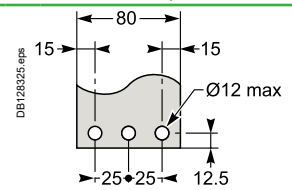
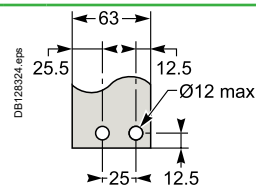
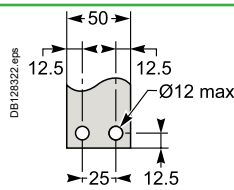

Top terminal

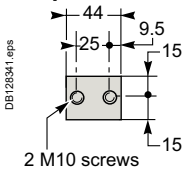

Bottom terminal

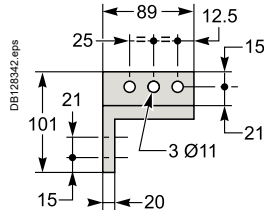
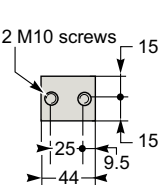

Power connections for ComPact NS1600b to 3200

Recommended drilling dimensions

Front connection (NS1600b to 2500)

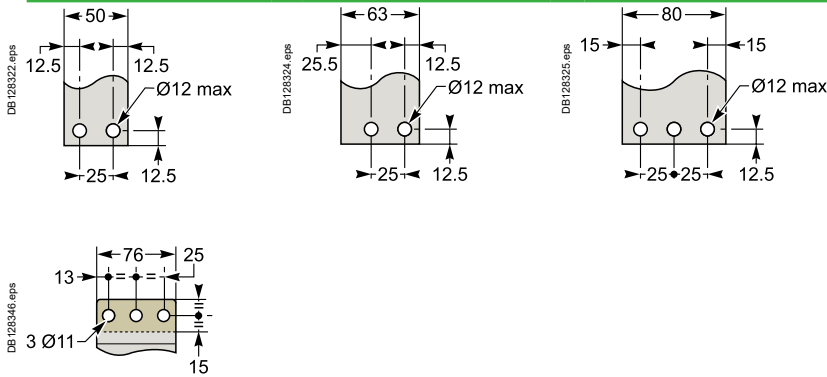

Front connection with vertical-connection adapter (NS1600b to 2500)

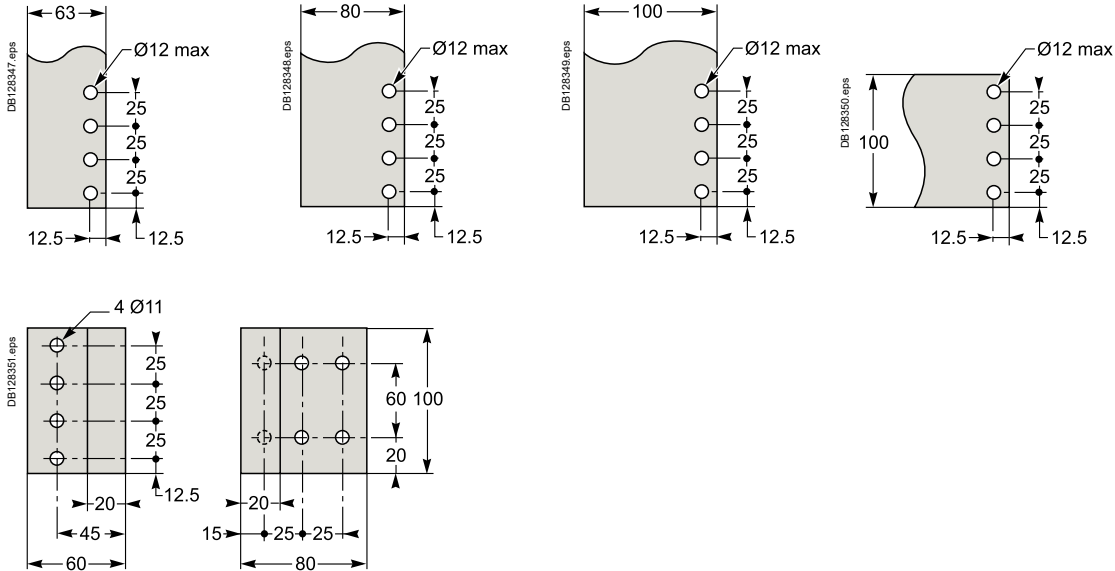

Front connection (NS3200)

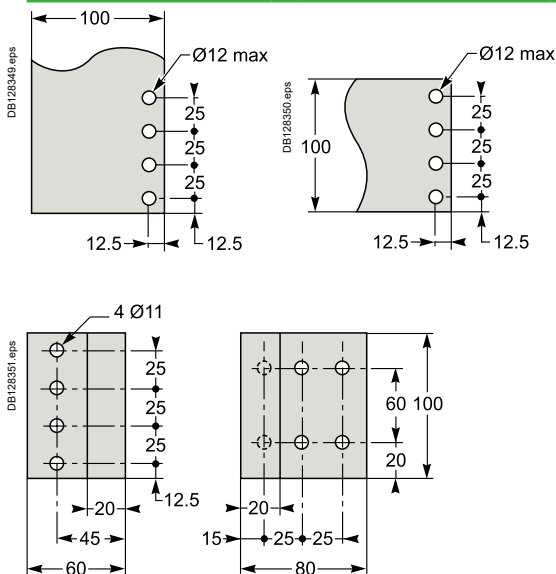

Power connections for ComPact NS630b to 3200

C

DB424722.eps

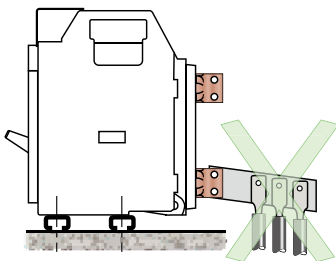

DB424721.eps

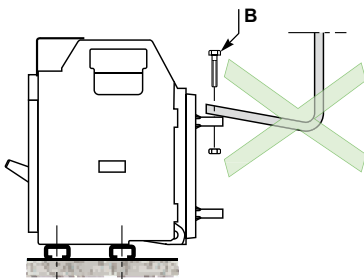

Conductor materials and electrodynamic stresses

ComPact circuit breakers can be connected indifferently with bare-copper, tinned-copper and tinned-aluminium conductors (flexible or rigid bars, cables). In the event of a short-circuit, thermal and electrodynamic stresses will be exerted on the conductors. They must therefore be correctly sized and maintained in place using supports.

Electrical connection points on all types of devices (switch-disconnectors, contactors, circuit breakers, etc.) should not be used for mechanical support. Any partition between upstream and downstream connections of the device must be made of non-magnetic material.

Ties for flexible bars and cables

The table below indicates the maximum distance between ties depending on the prospective short-circuit current. The maximum distance between ties attached to the switchboard frame is 400 mm.

Type of tie	"Panduit" ties			"Sarel" ties					
	Width: 4.5 mm			Width: 9 mm					
	Maximum load: 22 kg			Maximum load: 90 kg					
	Colour: white			Colour: black					
Maximum distance between ties (mm)	200	100	50	350	200	100	70	50	(double ties)
Short-circuit current (kArms)	10	15	20	20	27	35	45	100	

Note: For cables $\geq 50 \text{ mm}^2$, use 9 mm-wide ties.

DB128356.eps

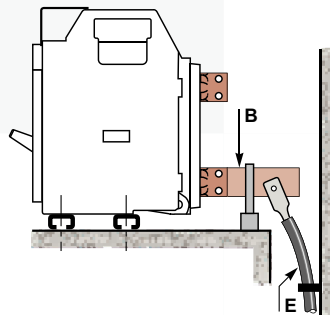

DB128357.eps

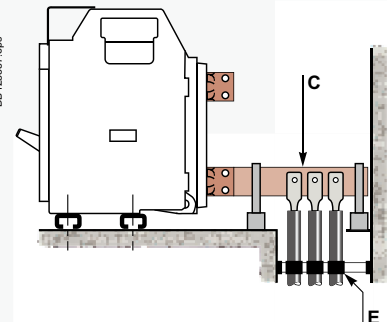

Connection of bars

Bars must be adjusted to ensure correct positioning on the terminals before bolting (B). Bars must rest on a support firmly attached to the switchboard frame, such that the circuit breaker terminals do not bear any weight (C).

Electrodynamic forces

The first spacer between bars must be positioned within a maximum distance (see table below) of the connection point to the circuit breaker. This distance is calculated to resist the electrodynamic stresses exerted between the bars of each phase during a short-circuit.

Maximum distance A between the circuit breaker connection and the first spacer between bars, depending on the short-circuit current

Isc (kA)	30	50	65	80	100	150
Distance (mm)	350	300	250	150	150	150

DB128359.eps

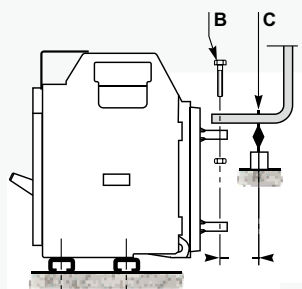

DB424720.eps

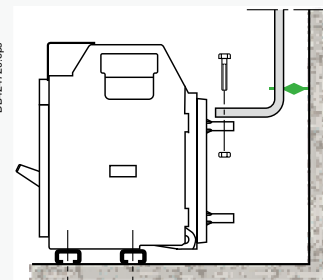

Power connections for ComPact NS630b to 3200

Connections

The quality of bar connections depends, among other things, on the tightening torques used for the nuts and bolts. Over-tightening may have the same consequences as under-tightening.

The correct tightening torques for the connection of bars to the circuit breaker terminals are indicated in the table below.

The values below are for copper bars (Cu ETP-NFA51-100) and steel nuts and bolts (class 8.8).

The same values apply to AGS-T52 quality aluminium bars (French standard NFA 02-104 and American National Standard H-35-1).

Examples of bar connections

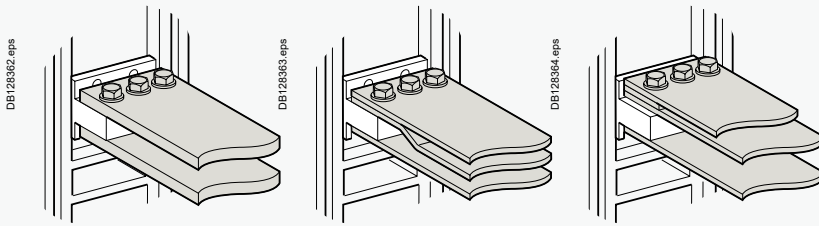

Tightening torque for bars			
Rated diameter (mm)	Drilling (mm) diameter	Tightening torque (Nm) with flat or grower washers	Tightening torque (Nm) with contact or split washers
10	11	37.5	50

Bar drilling

Examples

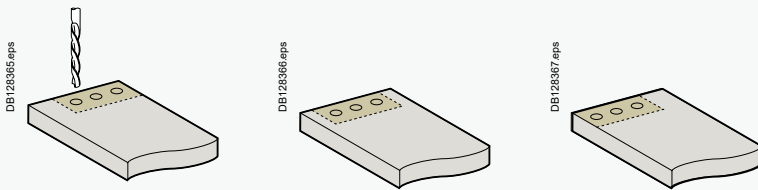

Insulation distance

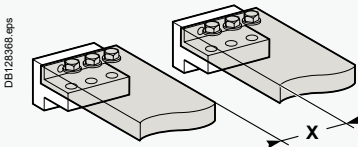

Dimensions (mm)

Utilisation voltage	X minimum
$U_i \leq 600\text{ V}$	8 mm
$U_i \leq 1000\text{ V}$	14 mm

Bar bending

Bars must be bent according to the table below. A tighter bend may cause cracks.

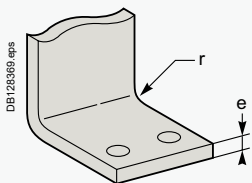

Dimensions (mm)

e	Radius r	
	Minimum	Recommended
5	5	7.5
10	15	18 to 20

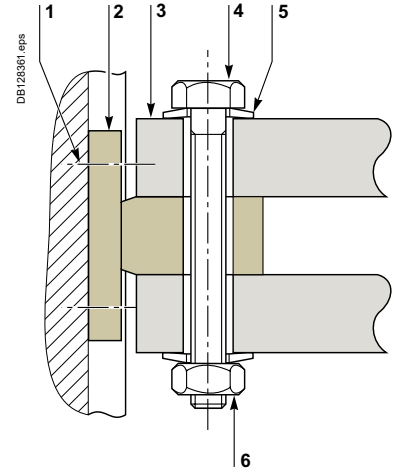

- 1 terminal screws, factory tightened to 13 Nm
- 2 circuit breaker terminal
- 3 bars
- 4 bolt with contact or split washers
- 5 washer
- 6z nut



Power connections for ComPact NS630b to 3200

Sizing of bars

The following tables are based on the following assumptions:

- maximum permissible temperature of bars is 100 °C
- Ti: temperature around the circuit breaker and its connections
- busbars made of copper and not painted.

Note: The values presented in the tables are the result of trials and theoretical calculations on the basis of the assumptions mentioned above. These tables are intended as an aid in designing connections, however, the actual values must be confirmed by tests on the installation.

Front or horizontal rear connections

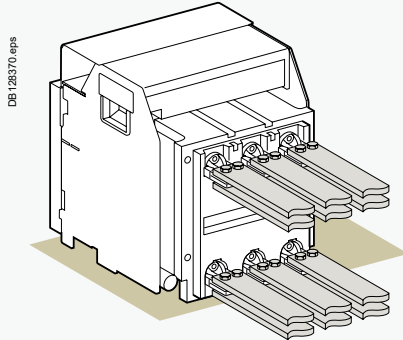

ComPact	Maximum service current	Ti: 40 °C		Ti: 50 °C		Ti: 60 °C	
		Number of bars		Number of bars		Number of bars	
		5 mm thick	10 mm thick	5 mm thick	10 mm thick	5 mm thick	10 mm thick
NS630b	400	2b.30 x 5	1b.30 x 10	2b.30 x 5	1b.30 x 10	2b.30 x 5	1b.30 x 10
NS630b	630	2b.40 x 5	1b.40 x 10	2b.40 x 5	1b.40 x 10	2b.40 x 5	1b.40 x 10
NS800	800	2b.50 x 5	1b.50 x 10	2b.50 x 5	1b.50 x 10	2b.50 x 5	1b.63 x 10
NS1000	1000	3b.50 x 5	1b.63 x 10	3b.50 x 5	2b.50 x 10	3b.63 x 5	2b.50 x 10
NS1250	1250	3b.50 x 5 2b.80 x 5	2b.40 x 10 2b.40 x 10	3b.50 x 5 2b.80 x 5	2b.50 x 10	3b.63 x 5	2b.50 x 10
NS1600/ 1600b	1400	2b.80 x 5	2b.40 x 10	2b.80 x 5	2b.50 x 10	3b.80 x 5	2b.63 x 10
NS1600/ 1600b	1600	3b.80 x 5	2b.63 x 10	3b.80 x 5	2b.63 x 10	3b.80 x 5	3b.50 x 10
NS2000	1800	3b.80 x 5	2b.63 x 10	3b.80 x 5	2b.63 x 10	3b.100 x 5	2b.80 x 10
NS2000	2000	3b.100 x 5	2b.80 x 10	3b.100 x 5	2b.80 x 10	3b.100 x 5	3b.63 x 10
NS2500	2200	3b.100 x 5	2b.80 x 10	3b.100 x 5	2b.80 x 10	4b.80 x 5	2b.100 x 10
NS2500	2500	4b.100 x 5	2b.100 x 10	4b.100 x 5	2b.100 x 10	4b.100 x 5	3b.80 x 10
NS3200	2800	4b.100 x 5	3b.80 x 10	4b.100 x 5	3b.80 x 10	5b.100 x 5	3b.100 x 10
NS3200	3000	5b.100 x 5	3b.80 x 10	6b.100 x 5	3b.100 x 10	8b.100 x 5	4b.80 x 10
NS3200	3200	6b.100 x 5	3b.100 x 10	8b.100 x 5	3b.100 x 10		4b.100 x 10

Note: With ComPact NS630b to NS1600, it is recommended to use 50 mm wideness bars (see "Recommended busbars drilling").

Power connections for ComPact NS630b to 3200

Sizing of bars

Vertical rear connections

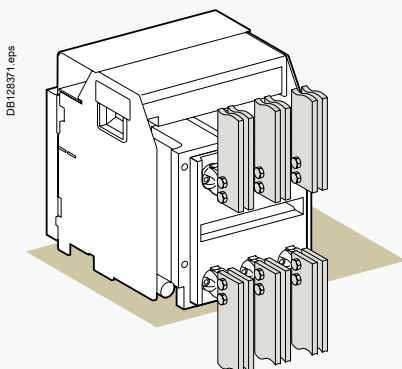

ComPact	Maximum service current	Ti: 40 °C		Ti: 50 °C		Ti: 60 °C	
		Number of bars 5 mm thick	10 mm thick	Number of bars 5 mm thick	10 mm thick	Number of bars 5 mm thick	10 mm thick
NS630b	400	2b.30 x 5	1b.30 x 10	2b.30 x 5	1b.30 x 10	2b.30 x 5	1b.30 x 10
NS630b	630	2b.40 x 5	1b.40 x 10	2b.40 x 5	1b.40 x 10	2b.40 x 5	1b.40 x 10
NS800	800	2b.50 x 5	1b.50 x 10	2b.50 x 5	1b.50 x 10	2b.50 x 5	1b.50 x 10
NS1000	1000	2b.50 x 5	1b.50 x 10	2b.50 x 5	1b.50 x 10	2b.63 x 5	1b.63 x 10
NS1250	1250	2b.63 x 5	1b.63 x 10	3b.50 x 5	2b.40 x 10	3b.50 x 5	2b.40 x 10
NS1600	1400	2b.80 x 5	1b.80 x 10	2b.80 x 5	2b.50 x 10	3b.63 x 5	2b.50 x 10
NS1600	1600	3b.63 x 5	2b.50 x 10	3b.63 x 5	2b.50 x 10	3b.80 x 5	2b.63 x 10
NS2000	2000	3b.100 x 5	2b.63 x 10	3b.100 x 5	2b.63 x 10	3b.100 x 5	2b.80 x 10
NS2500	2500	4b.100 x 5	2b.80 x 10	4b.100 x 5	2b.80 x 10	4b.100 x 5	3b.80 x 10
NS3200	3200	6b.100 x 5	3b.100 x 10	6b.100 x 5	3b.100 x 10		4b.100 x 10



Electrical diagrams

ComPact NS630b to 1600

Fixed circuit breakers D-2

Withdrawable circuit breakers D-4

ComPact NS1600b to 3200

Fixed circuit breakers D-6

ComPact NS630b to 3200

Earth-fault and earth-leakage protection Neutral protection

Zone selective interlocking D-8

ComPact NS630b to 3200

Communication D-10

Fixed, electrically operated ComPact NS630b to 3200

Connection to the communication interface module D-11

Connection to the I/O application module and communication interface module ... D-12

ComPact NS630b to 3200

Connection of the 24 V DC external power supply AD module D-13

D

ComPact NS630b to 1600

Fixed circuit breakers

The diagram is shown with circuits de-energised, all devices open, connected and charged and relays in the normal position.

Power

Control unit

Remote operation

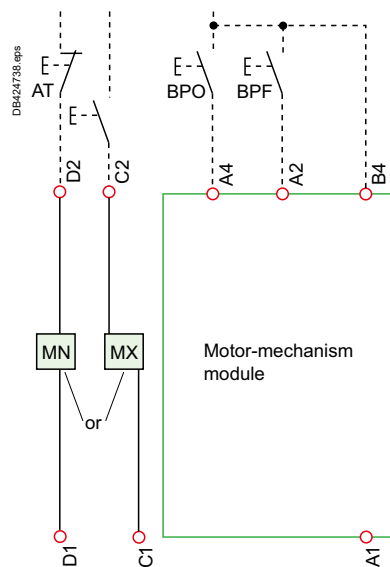
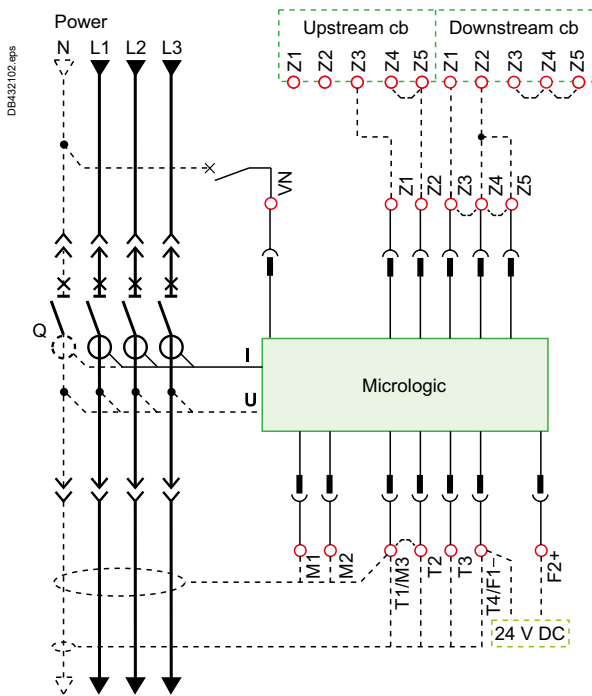

Basic A E P



Control unit

- E1-E6 communication
- Z1-Z5 zone selective interlocking:
Z1 = ZSI OUT SOURCE
Z2 = ZSI OUT ; Z3 = ZSI IN SOURCE
Z4 = ZSI IN ST (short time)
Z5 = ZSI IN GF (earth fault)
- M1 = Vigi module input (Micrologic 7)
- T1, T2, T3, T4 = external neutral;
- M2, M3 = Vigi module input (Micrologic 7)
- F2+, F1- external 24 V DC power supply
- VN external voltage connector (must be connected to the neutral with a 3P circuit breaker)

E : energy
A : digital ammeter.
P : A + power meter + additional protection.

Remote operation

- M** : undervoltage release
or
MX: shunt release
- Motor-mechanism module ^[1]
A4: electrical opening order
A2: electrical closing order
B4, A1: power supply for control devices and gear motor
- [1] Spring-charging motor 440/480 V AC (380 V motor + additional resistor)

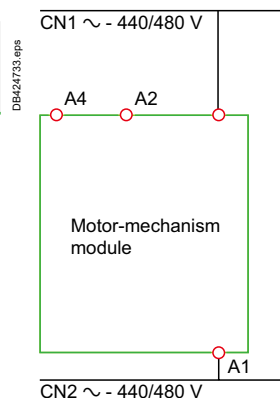

Electrical diagrams

ComPact NS630b to 1600

Fixed circuit breakers

Indication contacts

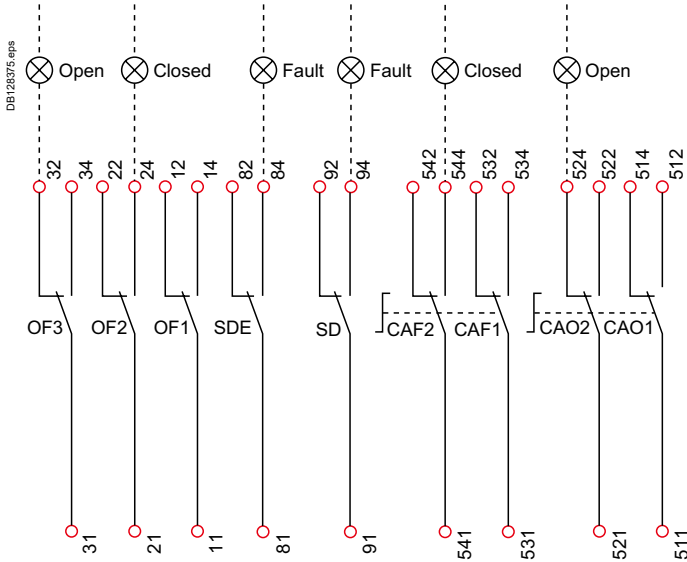

Terminal-block marking (manual operation)

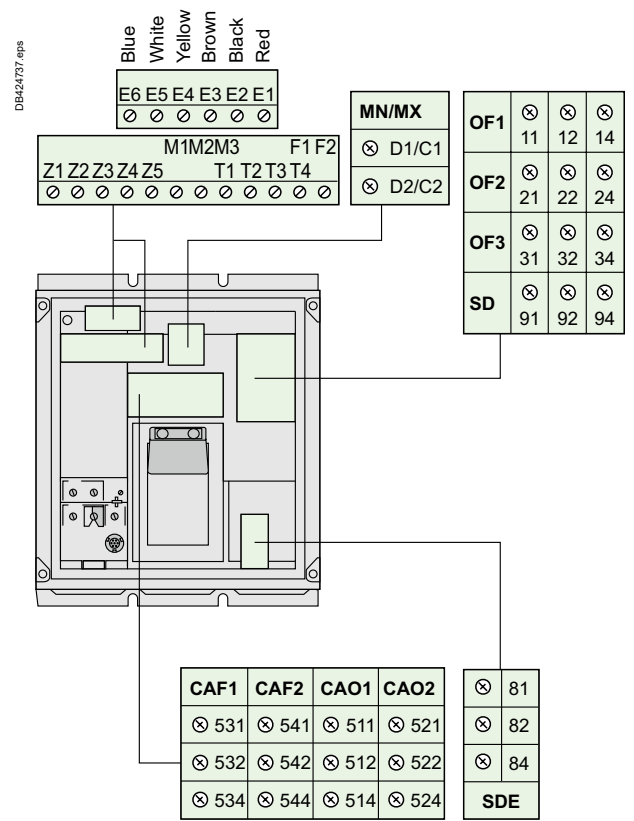

D

Indication contacts

OF3 / OF2 / OF1: indication contacts

SDE: fault-trip indication contact (short-circuit, overload, earth fault)

SD: trip indication contact (manual operation)

CAF2/CAF1: early-make contact (rotary handle)

CAO2 / CAO1: early-break contact (rotary handle)

Terminal-block marking (electrical operation)

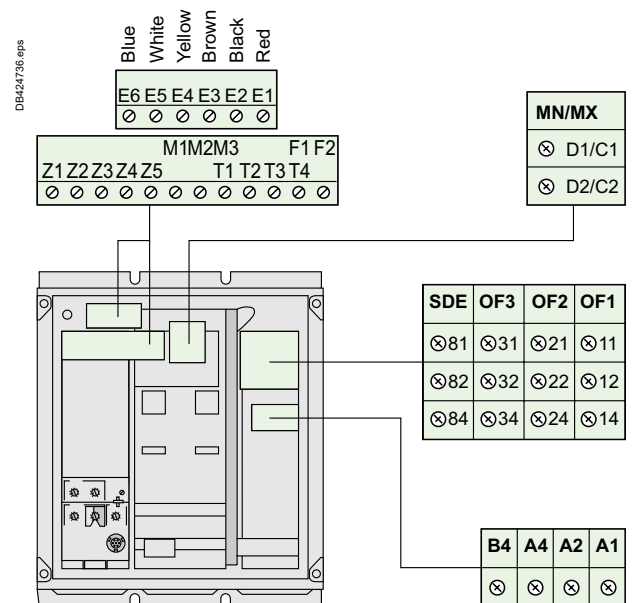

ComPact NS630b to 1600

Withdrawable circuit breakers

The diagram is shown with circuits de-energised, all devices open, connected and charged and relays in the normal position.

Power

Control unit

Remote operation

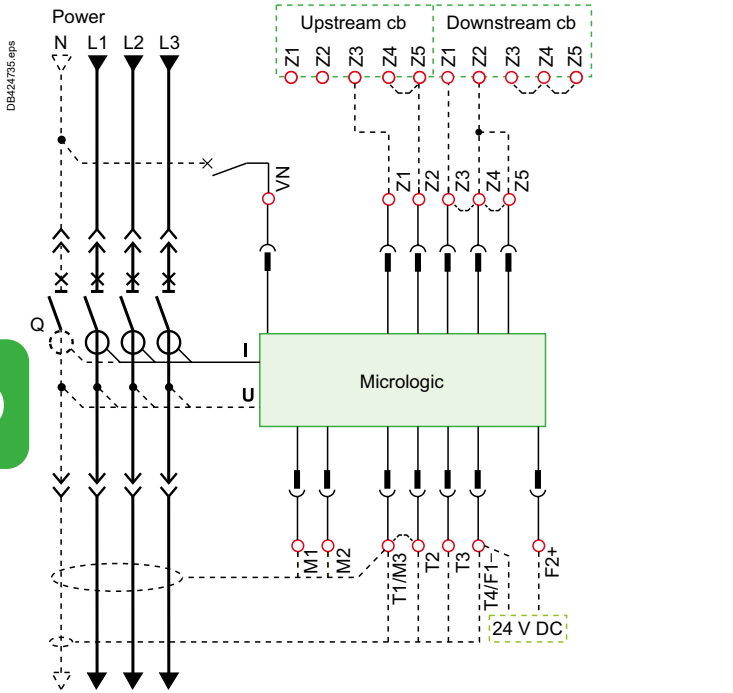

Terminal-block marking

Control unit

Com	UC1	UC2	UC3	CAF2
○ ○	○ ○	○ ○	○ ○	○ ○
E5 E6	Z5 M1	M2M3	F2+	544
○ ○	○ ○	○ ○	○ ○	○ ○
E3 E4	Z3 Z4	T3 T4	VN	542
○ ○	○ ○	○ ○	○ ○	○ ○
E1 E2	Z1 Z2	T1 T2	F1-	541

Remote operation

MN / MX	MT2	MT1
○ ○ / ○ ○	○ ○	○ ○
D2 C2	A4	A2
		○ ○
		B4
○ ○ / ○ ○		○ ○
D1 C1	A1	

Basic A E P

Control unit

● ● ● ●	Com: E1-E6 communication
● ● ● ●	UC1: Z1-Z5 zone selective interlocking: Z1 = ZSI OUT SOURCE Z2 = ZSI OUT; Z3 ZSI IN SOURCE Z4 = ZSI IN ST (short time) Z5 = ZSI IN GF (earth fault)
● ●	M1 = Vigi module input (Micrologic 7)
● ● ● ●	UC2: T1, T2, T3, T4 = external neutral; M2, M3 = Vigi module input (Micrologic 7)
● ● ● ●	UC3: F2+, F1- external 24 V DC power supply VN external voltage connector (must be connected to the neutral with a 3P circuit breaker)

Remote operation

MN: undervoltage release
or
MX: shunt release

Motor-mechanism module
MT2: A4 : electrical opening order
MT1: A2 : electrical closing order
B4, A1 : power supply for control devices and gear motor (MCH)

A : digital ammeter.

P : A + power meter + additional protection.

Electrical diagrams

ComPact NS630b to 1600

Withdrawable circuit breakers

Indication contacts

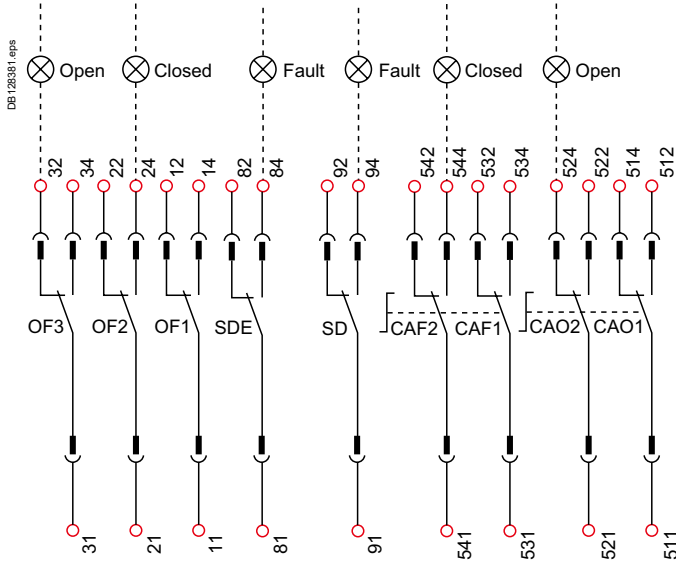

Indication contacts

CAF2	CAF1	SDE	SD	CAO2	CAO1	OF3	OF2	OF1
544	534	84	94	524	514	34	24	14
542	532	82	92	522	512	32	22	12
541	531	81	91	521	511	31	21	11

Indication contacts

OF3 / OF2 / OF1: indication contacts

SDE: fault-trip indication contact (short-circuit, overload, earth fault)

SD: trip indication contact (manual operation)

CAF2/CAF1: early-make contact (rotary handle)

CAO2 / CAO1: early-break contact (rotary handle)

Carriage switches

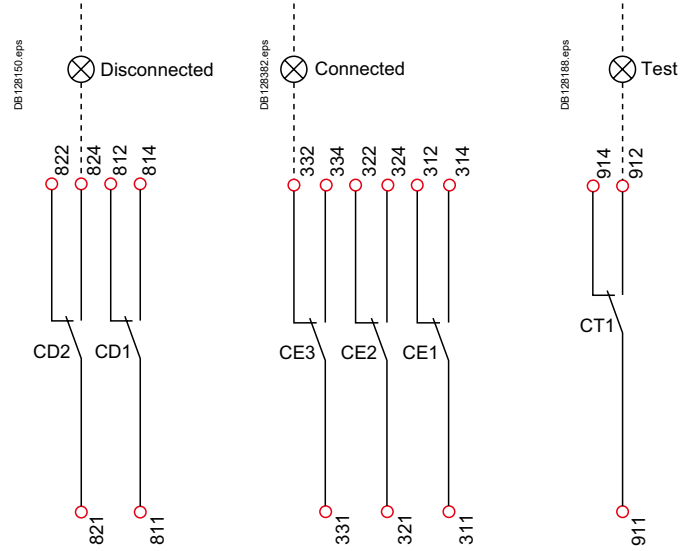

Carriage switches

CD2	CD1	CE3	CE2	CE1	CT1
824	814	334	324	314	914
822	812	332	322	312	912
821	811	331	321	311	911

Carriage switches

CD2: disconnected

CD1: position

CE3: connected

CE2: position

CE1

CT1: test position

Legend

○—○ Connected (only one wire per connection point).

ComPact NS1600b to 3200

Fixed circuit breakers

The diagram is shown with circuits de-energised, all devices open, connected and charged and relays in the normal position.

Power

Control unit

Remote operation

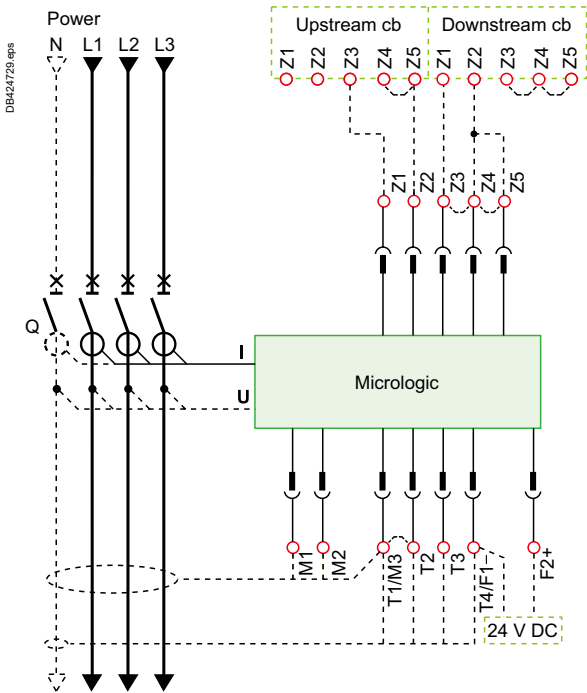

– (basic) A E Control unit

–	A	E	Control unit
●	●	●	E1-E6 communication
	●	●	Z1-Z5 zone selective interlocking: Z1 = ZSI OUT SOURCE Z2 = ZSI OUT ; Z3 = ZSI IN SOURCE Z4 = ZSI IN ST (short time) Z5 = ZSI IN GF (earth fault) M1 = Vigi module input (Micrologic 7) T1, T2, T3, T4 = external neutral; M2, M3 = Vigi module input (Micrologic 7)
	●	●	F2+, F1- external 24 V DC power supply

– : basic Micrologic control unit.

A: digital ammeter.

Remote operation

MN: undervoltage release
or
MX: shunt release

Electrical diagrams

ComPact NS1600b to 3200

Fixed circuit breakers

Indication contacts

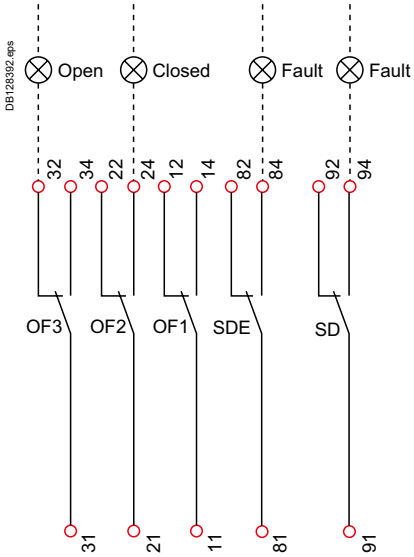

Terminal-block marking

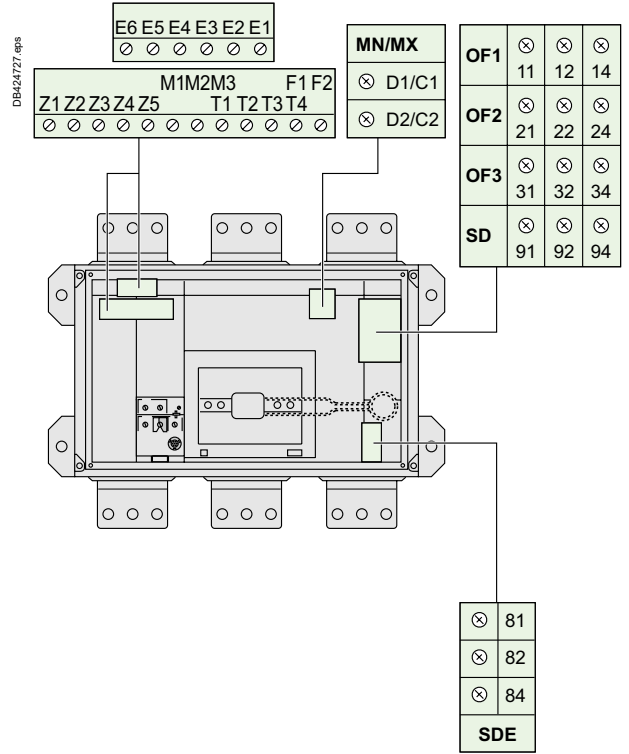

Indication contacts

OF3 / OF2 / OF1: ON / OFF indication contacts

SDE: fault-trip indication contact (short-circuit, overload, earth fault)

SD: trip indication contact



ComPact NS630b to 3200

Earth-fault and earth-leakage protection

Neutral protection Zone selective interlocking

External sensor (CT) for residual earth-fault protection

Connection of current-transformer secondary circuit for external neutral

ComPact equipped with a Micrologic 6 A/E/P [1]:

- shielded cable with 2 twisted pairs
- T1 twisted with T2
- maximum length 4 meters
- cable cross-sectional area 0.4 to 1.5 mm²
- recommended cable: Belden 9552 or equivalent.

For proper wiring of neutral CT, refer to instruction Bulletin 48041-082-03 shipped with it.

Do not remove Micrologic factory-installed jumper between T1 and T2 unless neutral CT is connected.

If supply is via the top, follow the schematics.

If supply is via the bottom, control wiring is identical; for the power wiring, H1 is connected to the source side, H2 to the load side.

For four-pole versions, for residual earth-fault protection, the current transformer for the external neutral is not necessary.

Connection for signal VN is required only for power measurements (3 Ø, 4 wires, 4CTs).

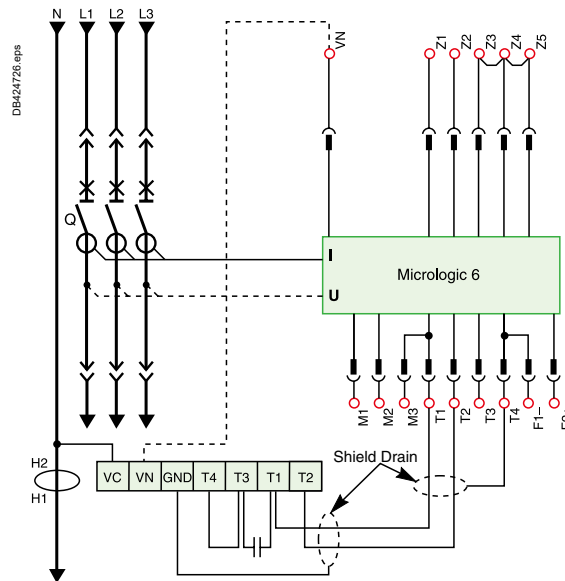

[1] Only for NS630b to 1600.

External transformer for source ground return (SGR) earth-fault protection

Connection of the secondary circuit

ComPact equipped with a Micrologic 6 A/E/P [1]:

- unshielded cable with 1 twisted pair
- maximum length 150 metres
- cable cross-sectional area 0.4 to 1.5 mm²
- recommended cable: Belden 9409 or equivalent.

[1] Only for NS630b to 1600.

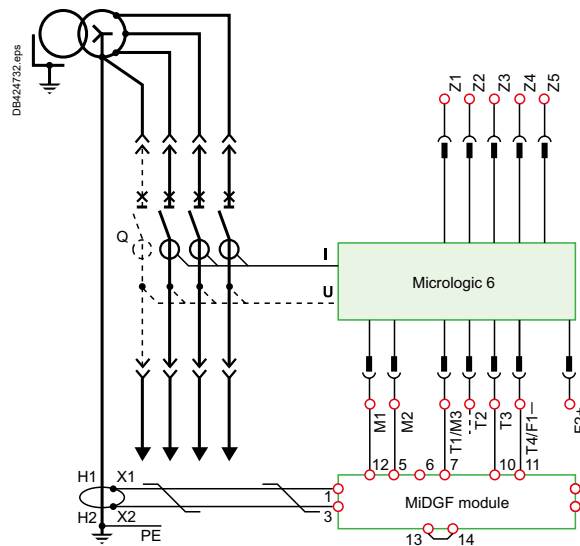

ComPact NS630b to 3200

Earth-fault and earth-leakage protection

Neutral protection Zone selective interlocking

Earth-leakage protection

Connection of the rectangular-sensor secondary circuit

ComPact equipped with a Micrologic 7 A/P: use the cable shipped with the rectangular sensor.

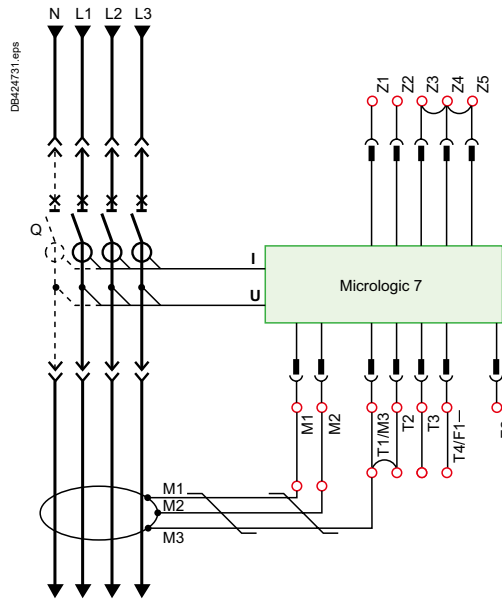

Neutral protection

- three pole circuit breaker:
 - neutral protection is impossible with Micrologic A,E
 - with Micrologic P, an external neutral transformer is necessary; the connection diagram is the same as for residual earth-fault protection.
- four pole circuit breaker:
 - ComPact equipped with Micrologic A,E,P
 - the current transformer for external neutral is not necessary.

Zone selective interlocking

Zone-selective interlocking is used to reduce the electrodynamic forces exerted on the installation by shortening the time required to clear faults, while maintaining time selectivity between the various devices.

A pilot wire interconnects a number of circuit breakers equipped with Micrologic A/E/P control units, as illustrated in the diagram above.

The control unit detecting a fault sends a signal upstream and checks for a signal arriving from downstream. If there is a signal from downstream, the circuit breaker remains closed for the full duration of its tripping delay. If there is no signal from downstream, the circuit breaker opens immediately, regardless of the tripping-delay setting.

Fault 1.

Only circuit breaker A detects the fault. Because it receives no signal from downstream, it immediately opens in spite of its tripping delay set to 0.3.

Fault 2.

Circuit breakers A and B detect the fault. Circuit breaker A receives a signal from B and remains closed for the full duration of its tripping delay set to 0.3. Circuit breaker B does not receive a signal from downstream and opens immediately, in spite of its tripping delay set to 0.2.

Wiring

- Maximum impedance: 2.7 Ω / 300 m.
- Capacity of connectors: 0.4 to 2.5 mm²
- Wires: single or multicore.
- Maximum length: 3000 m.
- Limits to device interconnection:
 - the common ZSI - OUT (Z1) and the output ZSI - OUT (Z2) can be connected to a maximum of 10 upstream device
 - a maximum of 100 downstream devices may be connected to the common ZSI - IN (Z3) and to an input ZSI - IN CR (Z4) or GF (Z5).

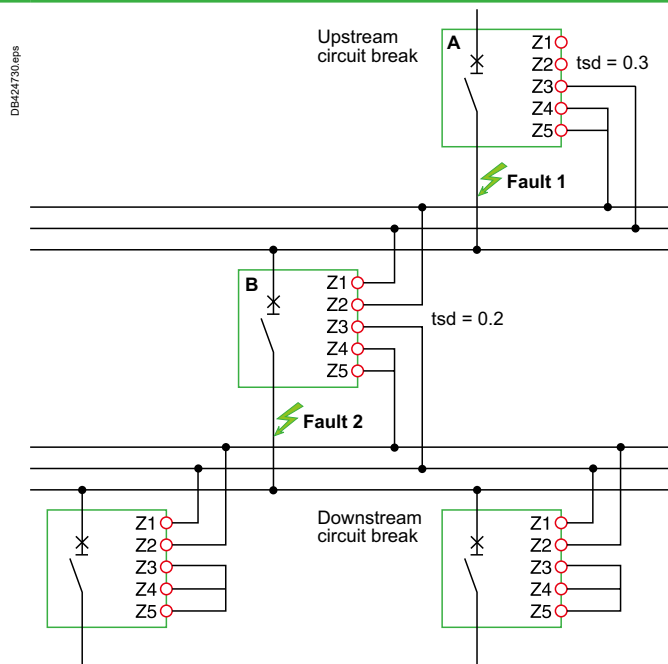

ComPact NS630b to 3200 Communication

Connection of circuit breakers to the Modbus communication network

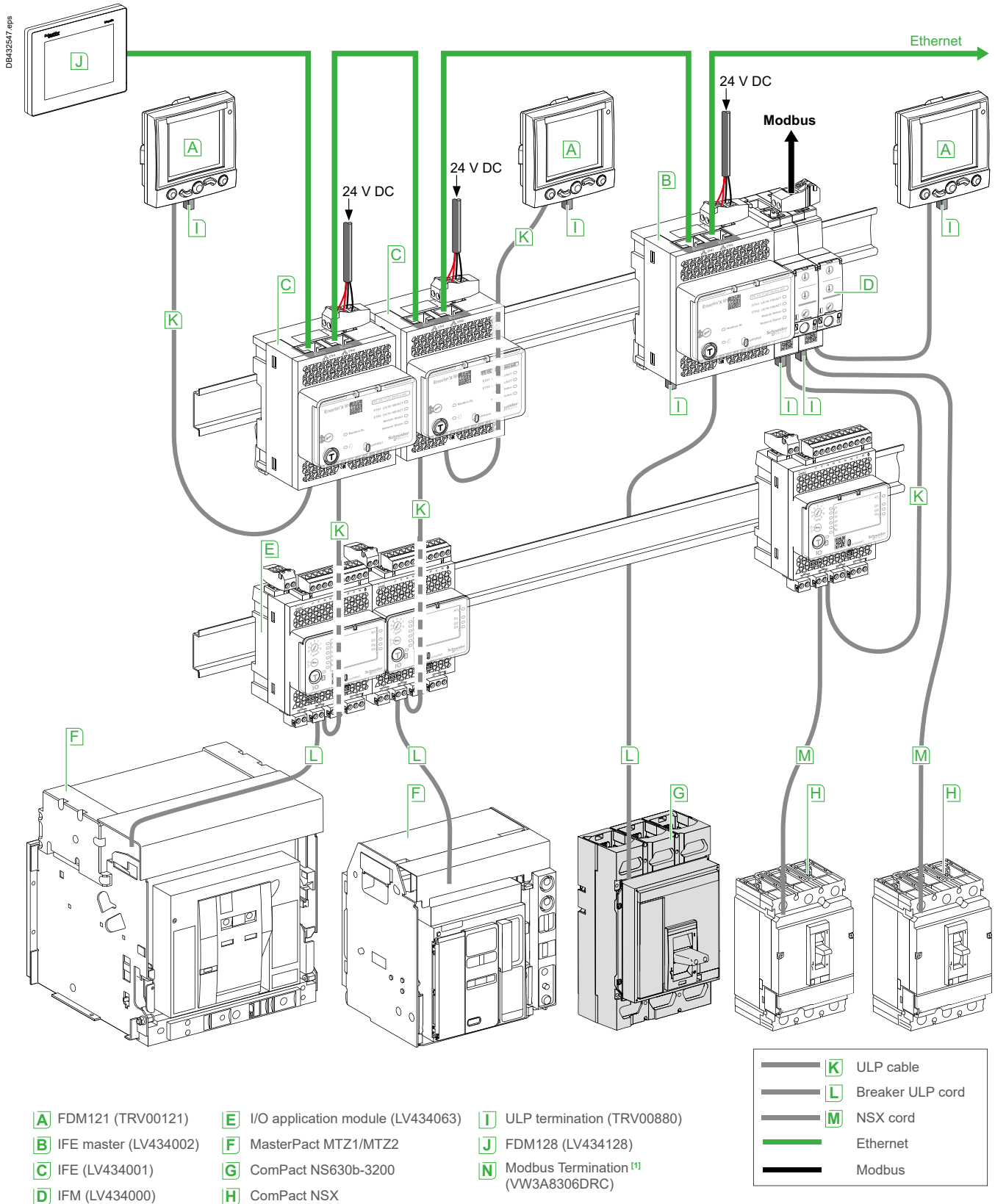

[1] Modbus termination is mandatory, see ULP system user guide TRV99101.

Fixed, electrically operated ComPact NS630b to 3200

Connection to the communication interface module

DB432548 eps

Color			
Red		E1	24 V
Black		E2	0 V
White		E5	H
Blue		E6	L

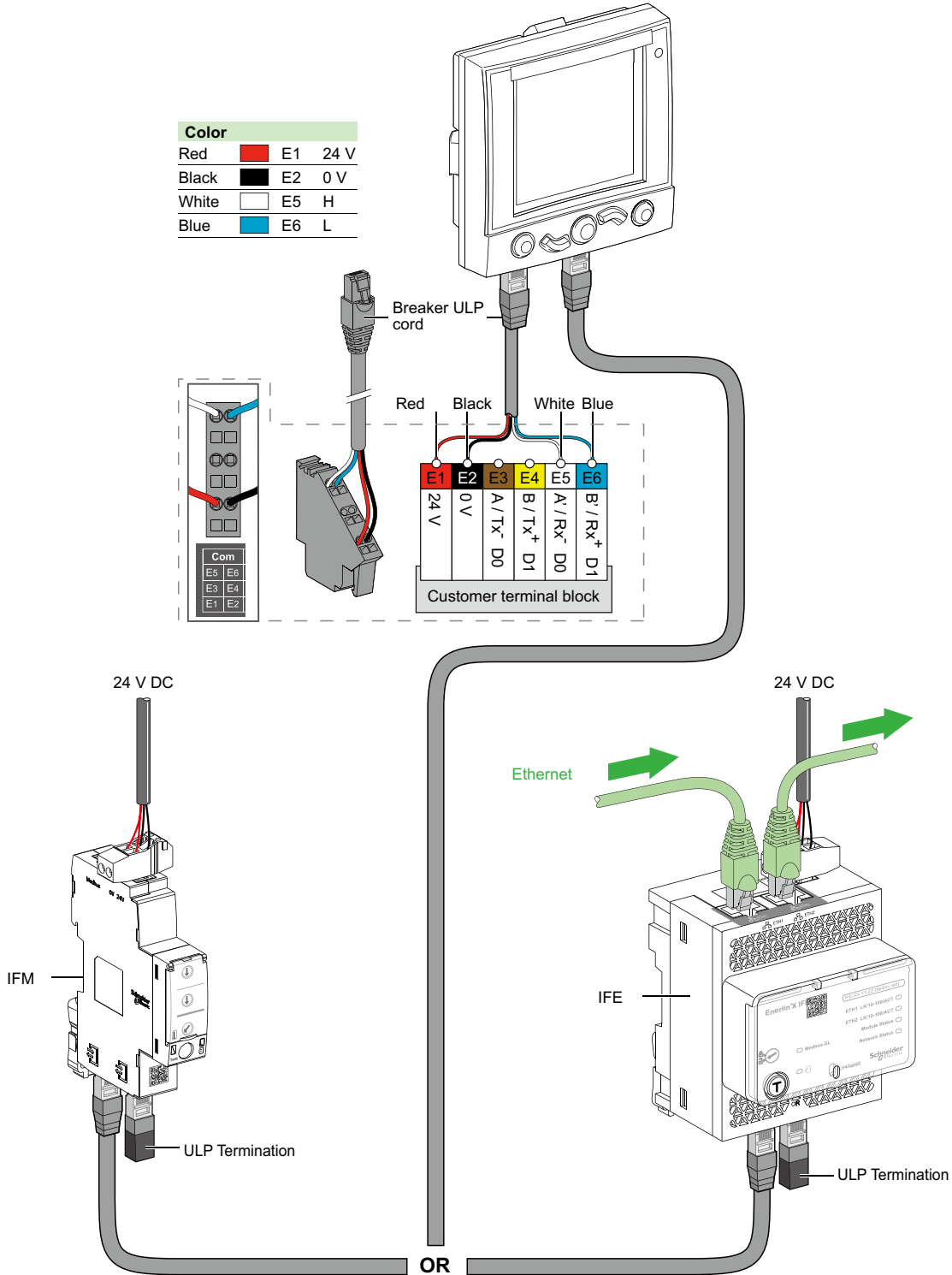

Withdrawable ComPact NS630b to 3200

Connection to the I/O application module and communication interface module

DB42249.eps

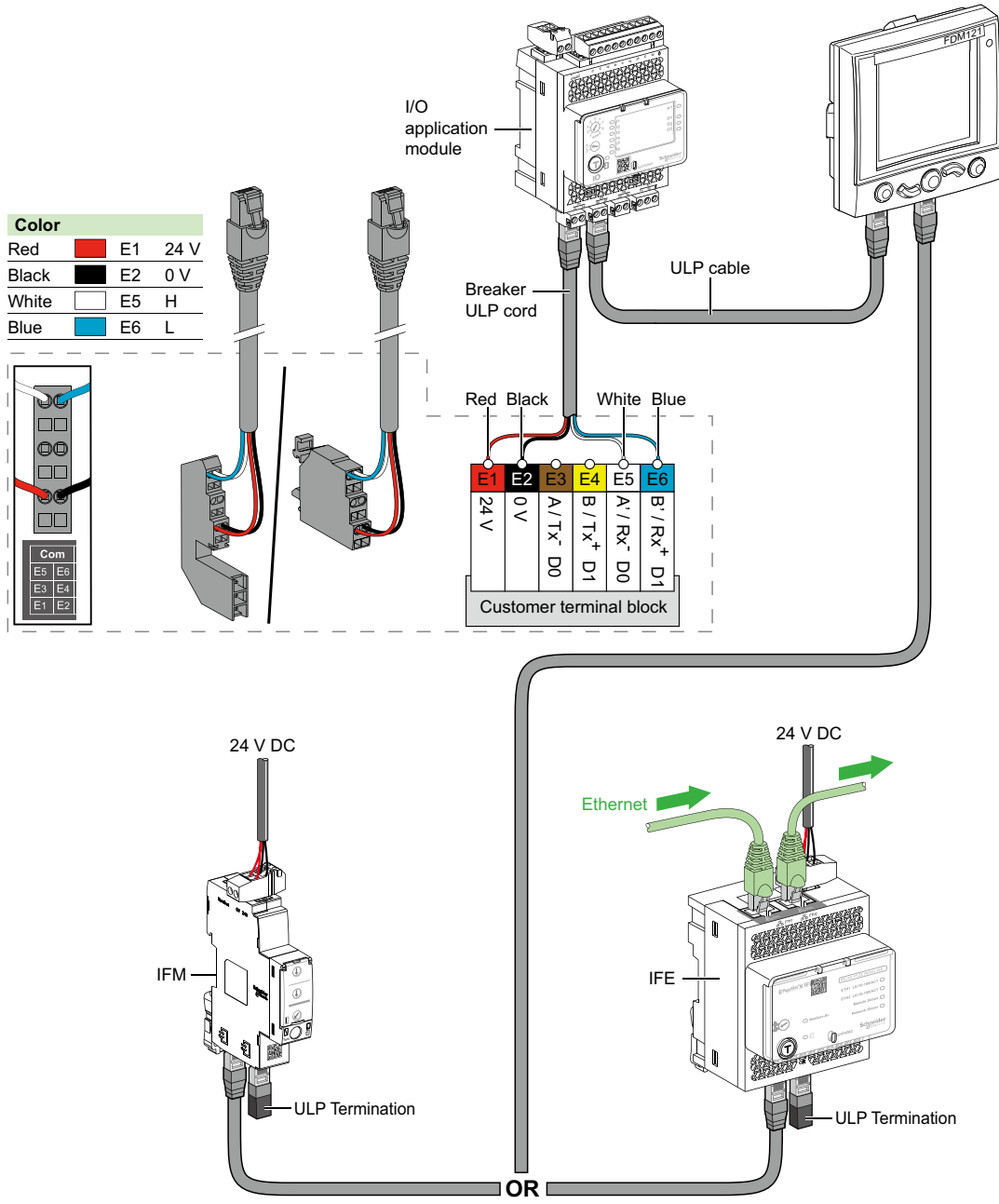

D

ComPact NS630b to 3200

24 V DC external power supply AD module

- With Micrologic, it is recommended to connect 24 V DC external power supply (AD module) to the Micrologic control unit (F1- F2+) in order
 - to keep available the display and the energy metering, even if Current < 20 % In.
 - to use the display even if the circuit breaker is open or not supplied (for the exact conditions of use, see the “electrical diagrams” part of this catalogue)
 - to display fault currents after tripping
 - to modify settings when the circuit breaker is open (OFF position).
- The same 24 V DC external power supply can be used for the micrologic control unit and the communication devices (IFE, IFM, I/O, FDM).
- The 24 V DC external power supply (AD module) for the Micrologic control unit (F1- F2+) is not required for basic protections LSIG.
- The 24 V DC external power supply for the BCM ULP communication module (E1-E2) is required. The same 24 V DC external power supply can be used for the communication devices (IFE, IFM, I/O, FDM).
- If the 24 V DC external power supply (AD module) is used to supply Micrologic control unit, this power supply shall be used only for supplying Micrologic control unit and M2C.
- The dedicated AD power supply shall be used only for the Micrologic trip unit. If the COM option is used, a second dedicated 24 V DC external power supply shall be used.

Note: case of using the 24 V DC external power supply (AD module), maximum cable length between 24 V DC (G1, G2) and the control unit (F1-, F2+) must not exceed 10 meters. The internal voltage taps are connected to the bottom side of the circuit breaker.

An external voltage taps are possible using the PTE option:

- With this option, the internal voltage taps are disconnected and the voltage taps are connected to terminals VN, V1, V2, V3.
- The PTE option is required for voltages less than 220 V and greater than 690 V (in which case a voltage transformer is compulsory). For three-pole devices, the system is supplied with terminal VN connected only to the control unit.
- When the PTE option is implemented, the voltage measurement input must be protected against short-circuits.

Installed as close as possible to the busbars, this protection function is ensured by a P25M circuit breaker (1 A rating) with an auxiliary contact (cat. no. 21104 and 21117).

- This voltage measurement input is reserved exclusively for the control unit and must not ever be used to supply other circuits outside the switchboard.

Connection

The maximum length for each conductor supplying power to the trip unit module is 10 m.

Do not ground F2+, F1-, or power supply output:

- the positive terminal (F2+) on the trip unit must not be connected to earth ground
- the negative terminal (F1-) on the trip unit must not be connected to earth ground
- the output terminals (- and +) of the 24 V DC power supply must not be grounded.

Reduce electromagnetic interference:

- the input and output wires of the 24 V DC power supply must be physically separated as much as possible
- the 24 V DC wires (output of the 24 V DC power supply) shall be twisted together
- the 24 V DC wires (output of the 24 V DC power supply) must cross all power cables perpendicularly
- power supply conductors must be cut to length. Do not loop excess conductor.

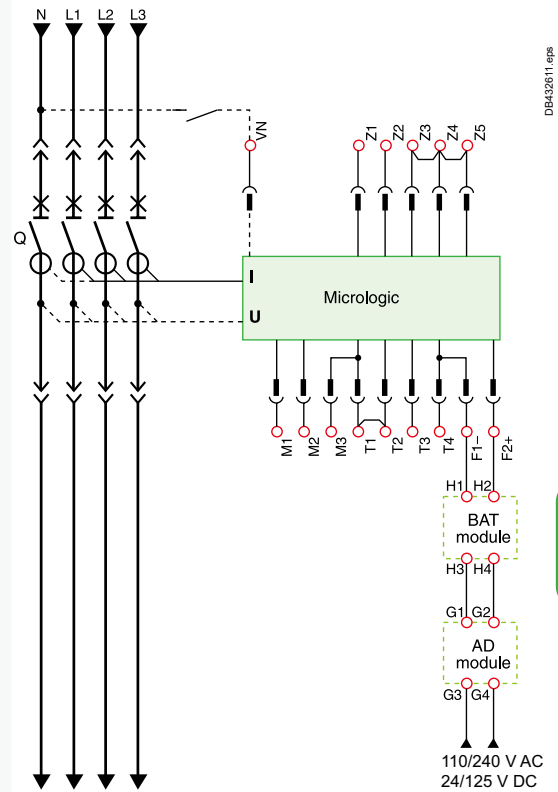

DE432611.eps

D



Message 1 1 1

4.13

W 1 2 3
A B C

100%
40%

1 2 3
A B C

1 2 3
A B C

1 2 3
A B C

1 2 3
A B C

1 2 3
A B C

1 2 3
A B C

1 2 3
A B C

1 2 3
A B C

1 2 3
A B C

1 2 3
A B C

1 2 3
A B C

1 2 3
A B C

1 2 3
A B C

1 2 3
A B C

1 2 3
A B C

1 2 3
A B C

1 2 3
A B C

1 2 3
A B C

1 2 3
A B C

1 2 3
A B C

1 2 3
A B C



Compact

NSX100M 100A 3P

100A 3P 100A 3P

100A 3P 100A 3P

100A 3P 100A 3P

100A 3P 100A 3P

100A 3P 100A 3P

100A 3P 100A 3P

100A 3P 100A 3P

100A 3P 100A 3P

100A 3P 100A 3P

100A 3P 100A 3P

100A 3P 100A 3P

100A 3P 100A 3P

100A 3P 100A 3P

100A 3P 100A 3P

100A 3P 100A 3P

100A 3P 100A 3P

100A 3P 100A 3P

100A 3P 100A 3P

100A 3P 100A 3P

100A 3P 100A 3P

100A 3P 100A 3P

100A 3P 100A 3P

100A 3P 100A 3P

100A 3P 100A 3P

100A 3P 100A 3P

100A 3P 100A 3P

100A 3P 100A 3P

100A 3P 100A 3P

100A 3P 100A 3P

Additional characteristics

Tripping curves	
ComPact NS630b to 3200	E-2
Current-limiting curves.....	E-3

E

Tripping curves

ComPact NS630b to 3200

Micrologic electronic control units

Micrologic 2.0

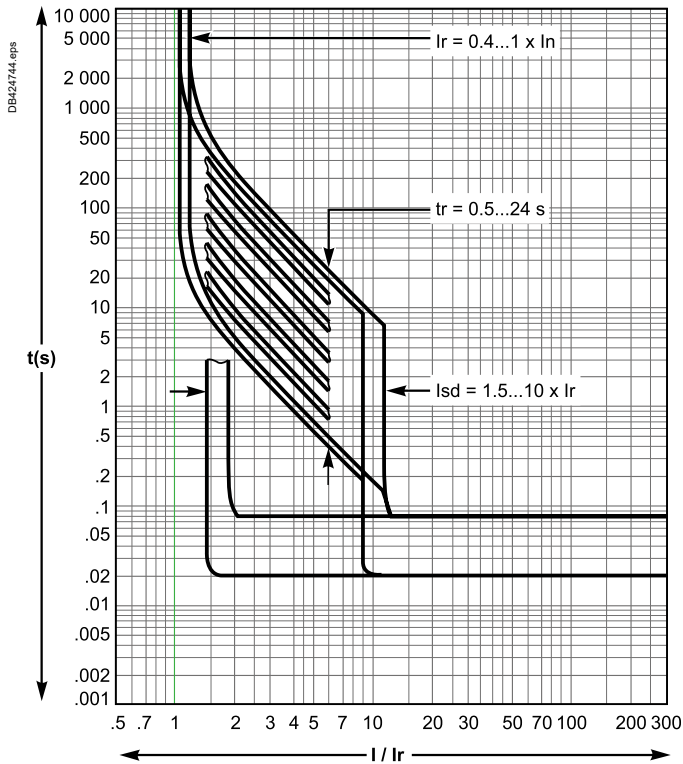

Micrologic 5.0, 6.0, 7.0

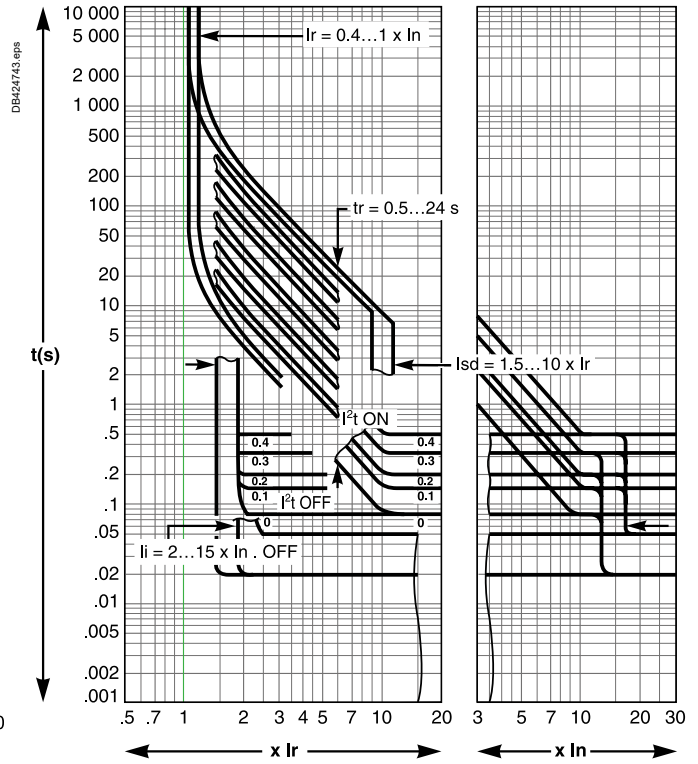

Earth-fault protection (Micrologic 6.0)

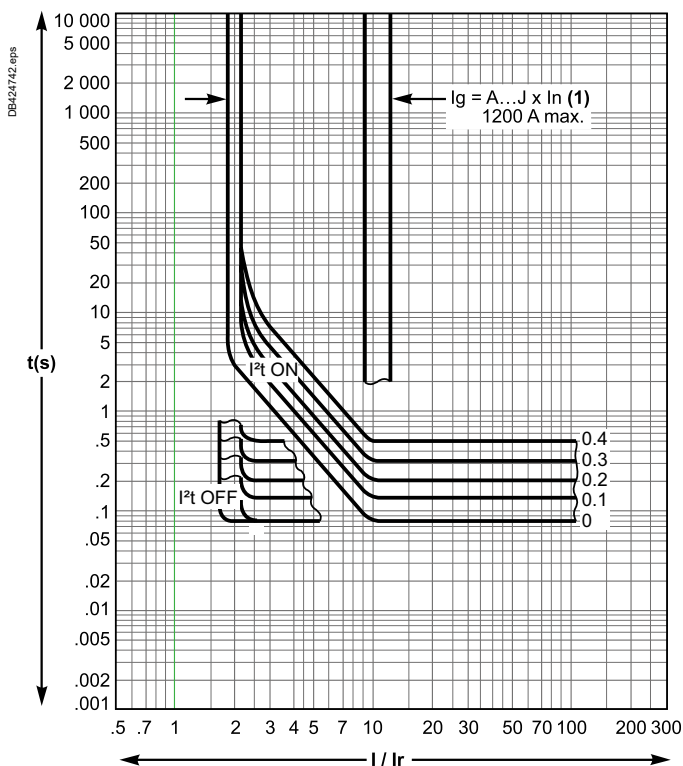

[1]

$I_g = I_n \times \dots$	A	B	C	D	E	F	G	H	J
$I_n < 400$ A	0.3	0.3	0.4	0.5	0.6	0.7	0.8	0.9	1
$400 \text{ A} \leq I_n \leq 1200$ A	0.2	0.3	0.4	0.5	0.6	0.7	0.8	0.9	1
$I_n > 1200$ A	500	640	720	800	880	960	1040	1120	1200

The limiting capacity of a circuit breaker is its aptitude to limit short-circuit currents.

Ics = 100 % Icu

The exceptional limiting capacity of the ComPact NS range greatly reduces the forces created by fault currents in devices.

The result is a major increase in breaking performance. In particular, the service breaking capacity Ics is equal to 100 % of Icu for limiter circuit breaker.

The Ics value, defined by IEC standard 60947-2, is guaranteed by tests comprising the following operations:

- break three times consecutively a fault current equal to 100 % of Icu
- check that the device continues to function normally:
 - it conducts the rated current without abnormal temperature rise
 - protection functions perform within the limits specified by the standard
 - suitability for isolation is not impaired.

Longer service life of electrical installations

Current-limiting circuit breakers greatly reduce the negative effects of short-circuits on installations.

Thermal effects

Less temperature rise in conductors, therefore longer service life for cables.

Mechanical effects

Reduced electrodynamic forces, therefore less risk of electrical contacts or busbars being deformed or broken.

Electromagnetic effects

Less disturbances for measuring devices located near electrical circuits.

Economy by means of cascading

Cascading is a technique directly derived from current limiting. Circuit breakers with breaking capacities less than the prospective short-circuit current may be installed downstream of a limiting circuit breaker. The breaking capacity is reinforced by the limiting capacity of the upstream device.

It follows that substantial savings can be made on downstream equipment and enclosures.

Current-limiting curves

The current-limiting capacity of a circuit breaker is expressed by two curves which are a function of the prospective short-circuit current (the current which would flow if no protection devices were installed):

- the actual peak current (limited current),
- thermal stress (A^2s), i.e. the energy dissipated by the short-circuit in a conductor with a resistance of 1Ω .

Example

What is the real value of a 200 kA rms prospective short-circuit (i.e. 440 kA peak) limited by an NS630bLB upstream ?

Answer: 70 kA peak (see next page).

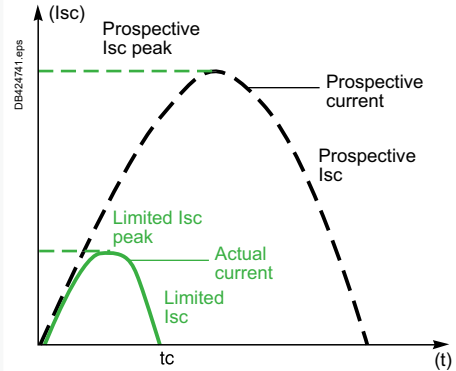

The exceptional limiting capacity of the ComPact NS range is due to the rotating double-break technique (very rapid natural repulsion of contacts and the appearance of two arc voltages in-series with a very steep wave front).



Catalogue numbers and order forms

NS630b to NS1600 fixed manually operated	
Complete device.....	F-2
Device based on separate components.....	F-4
NS630b to NS1600 fixed electrically operated	
Device based on separate components.....	F-5
NS630b to NS1600 manually operated withdrawable devices	
Device based on separate components.....	F-6
NS630b to NS1600 electrically operated withdrawable devices	
Device based on separate components.....	F-7
Accessories for NS630b to NS1600 fixed devices	F-8
Accessories for NS630b to NS1600 withdrawable devices	F-9
Accessories for NS630b to NS1600 fixed and withdrawable devices	F-11
Mechanical interlocking.....	F-12
Communication option for NS630b to NS1600 fixed and withdrawable devices	F-13
NS1600b to NS3200 fixed, front-connected, manually operated device	F-14
Accessories for NS1600b to NS3200	F-15
Spare parts: NS630b to NS1600 fixed circuit breaker	
Connection.....	F-16
Electrical auxiliaries and installation accessories.....	F-17
Micrologic control unit, external sensor.....	F-18
Locking and accessories.....	F-19
Spare parts: NS630b to NS1600 fixed and withdrawable circuit breaker	
Mechanical interlocking for source changeover.....	F-20
Spare parts: NS630b to NS1600 withdrawable circuit breaker	
Connection.....	F-21
Electrical auxiliaries.....	F-22
Installation accessories.....	F-23
Micrologic control unit, external sensor.....	F-24
Locking and accessories.....	F-25
Chassis locking and accessories Mechanical interlocking for source changeover..	F-26
Spare parts: NS630b to NS1600 fixed or withdrawable circuit breaker	
Instructions.....	F-27
Spare parts: Communication bus accessories, monitoring and control, ethernet gateway	F-28
Spare parts: ComPact NS1600b to 3200	
Connection, locking and installation accessories.....	F-29
Micrologic control unit, external sensor.....	F-30
Order form: ComPact NS630b to NS3200	
Circuit breakers and switch-disconnectors.....	F-31

NS630b to NS1600 fixed manually operated Complete device

Front-connected circuit breaker with Micrologic 2.0 control unit

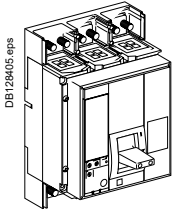

ComPact NS type N		
Icu = 50 kA at 220/415 V	3P	4P
NS630b	33460	33463
NS800	33466	33469
NS1000	33472	33475
NS1250	33478	33480
NS1600	33482	33484
ComPact NS type H		
Icu = 70 kA at 220/415 V	3P	4P
NS630b	33461	33464
NS800	33467	33470
NS1000	33473	33476
NS1250	33479	33481
NS1600	33483	33485
ComPact NS type L		
Icu = 150 kA at 220/415 V	3P	4P
NS630b	33462	33465
NS800	33468	33471
NS1000	33474	33477

Front-connected circuit breaker with Micrologic 5.0 control unit

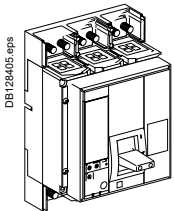

ComPact NS type N		
Icu = 50 kA at 220/415 V	3P	4P
NS630b	33546	33549
NS800	33552	33555
NS1000	33558	33561
NS1250	33564	33566
NS1600	33568	33570
ComPact NS type H		
Icu = 70 kA at 220/415 V	3P	4P
NS630b	33547	33550
NS800	33553	33556
NS1000	33559	33562
NS1250	33565	33567
NS1600	33569	33571
ComPact NS type L		
Icu = 150 kA at 220/415 V	3P	4P
NS630b	33548	33551
NS800	33554	33557
NS1000	33560	33563

Front-connected circuit breaker with Micrologic 6.0 control unit

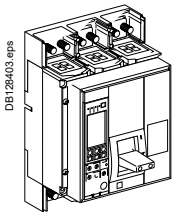

ComPact NS type N		
Icu = 50 kA at 220/415 V	3P	4P
NS630b	33886	33888
NS800	33893	33896
NS1000	33909	33917
NS1250	33919	33923
NS1600	33925	33927
ComPact NS type H		
Icu = 70 kA at 220/415 V	3P	4P
NS630b	33887	33889
NS800	33894	33901
NS1000	33916	33918
NS1250	33922	33924
NS1600	33926	33928

F

NS630b to NS1600 fixed manually operated Complete device

Front-connected circuit breaker with Micrologic 2.0 A control unit

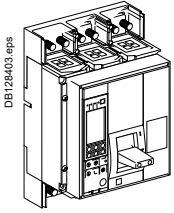

ComPact NS type N		
	3P	4P
Icu = 50 kA at 220/415 V		
NS630b	33223	33227
NS800	33233	33237
NS1000	33243	33247
NS1250	33253	33257
NS1600	33263	33267
ComPact NS type H		
	3P	4P
Icu = 70 kA at 220/415 V		
NS630b	33228	33229
NS800	33238	33239
NS1000	33248	33249
NS1250	33258	33259
NS1600	33268	33269
ComPact NS type L		
	3P	4P
Icu = 150 kA at 220/415 V		
NS630b	33497	33500
NS800	33498	33501
NS1000	33499	33502

Front-connected circuit breaker with Micrologic 5.0 A control unit

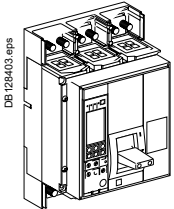

ComPact NS type N		
	3P	4P
Icu = 50 kA at 220/415 V		
NS630b	33323	33327
NS800	33333	33337
NS1000	33343	33347
NS1250	33353	33357
NS1600	33363	33367
ComPact NS type H		
	3P	4P
Icu = 70 kA at 220/415 V		
NS630b	33328	33329
NS800	33338	33339
NS1000	33348	33349
NS1250	33358	33359
NS1600	33368	33369
ComPact NS type L		
	3P	4P
Icu = 150 kA at 220/415 V		
NS630b	33516	33519
NS800	33517	33520
NS1000	33518	33521

Fixed front connected Micrologic 2.0 E

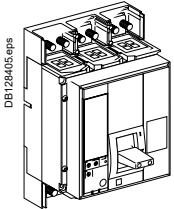

ComPact NS type N		
	3P	4P
NS630b	34400	34402
NS800	34404	34406
NS1000	34408	34410
NS1250	34412	34414
NS1600	34416	34418
ComPact NS type H		
	3P	4P
NS630b	34401	34403
NS800	34405	34407
NS1000	34409	34411
NS1250	34413	34415
NS1600	34417	34419

Fixed front connected Micrologic 5.0 E

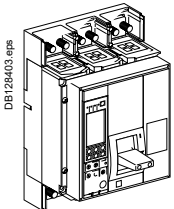

ComPact NS type N		
	3P	4P
NS630b	34420	34422
NS800	34424	34426
NS1000	34428	34430
NS1250	34432	34434
NS1600	34436	34438
ComPact NS type H		
	3P	4P
NS630b	34421	34423
NS800	34425	34427
NS1000	34429	34431
NS1250	34433	34435
NS1600	34437	34439

Front-connected switch-disconnector

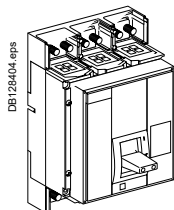

	3P	4P
NS630b	33486	33491
NS800	33487	33492
NS1000	33488	33493
NS1250	33489	33494
NS1600	33490	33495

Note: select in addition the connection accessories, device accessories and auxiliaries, control-unit accessories and communications option, as required.

NS630b to NS1600 fixed manually operated

Device based on separate components

Basic circuit breaker

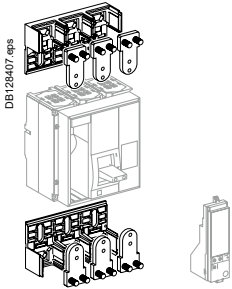

ComPact NS type N		
Icu = 50 kA at 220/415 V		
NS630b	3P	4P
NS800	33220	33224
NS1000	33230	33234
NS1250	33240	33244
NS1600	33250	33254
NS1600	33260	33264
ComPact NS type H		
Icu = 70 kA at 220/415 V		
NS630b	3P	4P
NS800	33221	33225
NS1000	33231	33235
NS1250	33241	33245
NS1600	33251	33255
NS1600	33261	33265
ComPact NS type L		
Icu = 150 kA at 220/415 V		
NS630b	3P	4P
NS800	33222	33226
NS1000	33232	33236
NS1000	33242	33246
ComPact NS type LB		
Icu = 200 kA at 400/415 V		
NS630b	3P	4P
NS800	48952	48955
NS800	48953	48956
Micrologic control units		
Without "measurement"		
Micrologic 2.0	basic protection	3P/4P
Micrologic 5.0	selective protection	33504
Micrologic 6.0	selective + earth-fault protection	33511
Micrologic 6.0	selective + earth-fault protection	33515
"ammeter" A		
Micrologic 2.0 A	basic protection	3P/4P
Micrologic 5.0 A	selective protection	33505
Micrologic 6.0 A	selective protection	33512
Micrologic 7.0 A	selective + earth-fault protection	33513
Micrologic 7.0 A	selective + earth-fault protection	33514
"energy" E ^[1]		
Micrologic 2.0 E	basic protection	3P/4P
Micrologic 5.0 E	selective protection	33535
Micrologic 6.0 E	selective protection	33537
Micrologic 6.0 E	selective + earth-fault protection	33539
"power meter" P ^[1]		
Micrologic 5.0 P	selective protection	3P/4P
Micrologic 6.0 P	selective protection	65290
Micrologic 7.0 P	selective + earth-fault protection	65291
Micrologic 7.0 P	selective + earth-fault protection	65292

[2] In case of an installation 3P + Neutral, please add ENVT device ref. 65317 (see page F-13).

Basic switch-disconnector

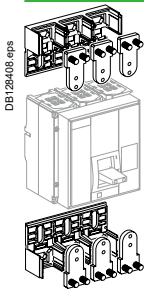

ComPact NS type NA		
NS630b	3P	4P
NS800	33420	33421
NS1000	33422	33423
NS1000	33424	33425
NS1250	33426	33427
NS1600	33428	33429

Connections for circuit breakers and switch-disconnectors

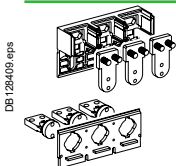

Front connection		
630-1000 A - NA/N/H	Top	3P
	Bottom	4P
1250 A - NA/N/H	Top	33598
630-1000 A - L	Bottom	33608
1600 A - NA/N/H	Top	33599
	Bottom	33609
	Top	33600
	Bottom	33601
	Top	33610
	Bottom	33611
	Top	33602
	Bottom	33612
	Bottom	33603
	Bottom	33613
Rear connection		
Vertical NA/N/H/L/LB	Top	3P
	Bottom	4P
	Top	33604
	Bottom	33614
Horizontal	Top	33605
	Bottom	33615
NA/N/H/L/LB	Top	33606
	Bottom	33616
	Bottom	33607
	Bottom	33617

Note: to order a complete device, order:

- a basic circuit breaker and a Micrologic control unit, or a basic switch disconnector.
- connections.
- accessories (for the device, the connection, the control unit) and communication option as required.

NS630b to NS1600 fixed electrically operated Device based on separate components

Basic circuit breaker

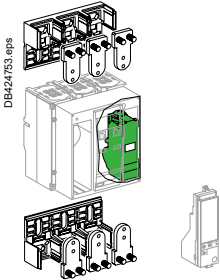

Note: the characteristics of the motor mechanism module for electrical operation are specified separately by selecting a part number from the table at the bottom of this page.

ComPact NS type N		
Icu = 50 kA at 220/415 V		
NS630b	3P	33270
NS800	3P	33280
NS1000	3P	33290
NS1250	3P	33300
NS1600	3P	33310

ComPact NS type H		
Icu = 70 kA at 220/415 V		
NS630b	3P	33271
NS800	3P	33281
NS1000	3P	33291
NS1250	3P	33301
NS1600	3P	33311

ComPact NS type L		
Icu = 150 kA at 220/415V		
NS630b	3P	33272
NS800	3P	33282
NS1000	3P	33292

Micrologic control units		
Without "measurement"		
Micrologic 2.0	basic protection	3P/4P 33504
Micrologic 5.0	selective protection	33511
Micrologic 6.0	selective + earth-fault protection	33515
"ammeter" A		
Micrologic 2.0 A	basic protection	3P/4P 33505
Micrologic 5.0 A	selective protection	33512
Micrologic 6.0 A	selective + earth-fault protection	33513
Micrologic 7.0 A	selective + earth-leakage protection	33514
"energy" E [1]		
Micrologic 2.0 E	basic protection	3P/4P 33535
Micrologic 5.0 E	selective protection	33537
Micrologic 6.0 E	selective + earth-fault protection	33539
"power meter" P [1]		
Micrologic 5.0 P	selective protection	3P/4P 65290
Micrologic 6.0 P	selective + earth-fault protection	65291
Micrologic 7.0 P	selective + earth-leakage protection	65292

[1] In case of an installation 3P + Neutral, please add ENVT device ref. 65317 (see page F-13).

Basic switch-disconnector

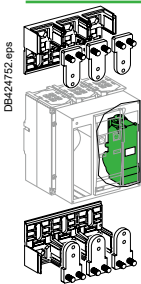

ComPact NS type NA		
NS630b	3P	33440
NS800	3P	33442
NS1000	3P	33444
NS1250	3P	33446
NS1600	3P	33448

Note: the characteristics of the motor mechanism module for electrical operation are specified separately by selecting a part number from the table at the bottom of this page.

Connections for circuit breakers and switch-disconnectors

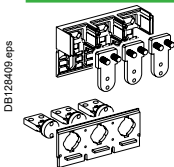

Front connection		
630-1000 A - NA/N/H	Top	3P 33598
	Bottom	33599
1250 A - NA/N/H	Top	33600
630-1000 A - L	Bottom	33601
1600 A - NA/N/H	Top	33602
	Bottom	33603
Rear connection		
Vertical NA/N/H/L	Top	33604
	Bottom	33605
Horizontal	Top	33606
NA/N/H/L	Bottom	33607

Motor mechanism module

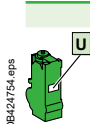

	AC 50/60 Hz		DC	
	Standard	Communicating	Standard	Communicating
48 V	33691 [2]	33698 [2]	24/30 V	33690 [2]
100/130 V	33687 [2]	33694 [2]	48/60 V	33691 [2]
220/240 V	33688 [2]	33695 [2]	100/130 V	33692 [2]
380/415 V	33689 [2]	33696 [2]	200/250 V	33693 [2]

Note: to order a complete device, order:
 ■ a basic circuit breaker and a Micrologic control unit, or a basic switch disconnector. ■ connections. ■ accessories (for the device, the connection, the control unit) and communication option as required.
 [2] Consult us.



NS630b to NS1600 manually operated withdrawable devices

Device based on separate components

Basic circuit breaker

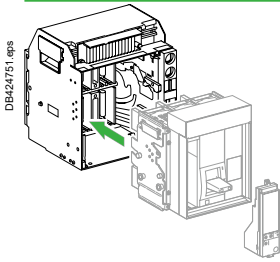

ComPact NS type N		
Icu = 50 kA at 220/415 V		
NS630b	3P	4P
	33320	33324
NS800	3P	4P
	33330	33334
NS1000	3P	4P
	33340	33344
NS1250	3P	4P
	33350	33354
NS1600	3P	4P
	33360	33364
ComPact NS type H		
Icu = 70 kA at 220/415 V		
NS630b	3P	4P
	33321	33325
NS800	3P	4P
	33331	33335
NS1000	3P	4P
	33341	33345
NS1250	3P	4P
	33351	33355
NS1600	3P	4P
	33361	33365
ComPact NS type L		
Icu = 150 kA at 220/415 V		
NS630b	3P	4P
	33322	33326
NS800	3P	4P
	33332	33336
NS1000	3P	4P
	33342	33346
ComPact NS type LB		
Icu = 200 kA at 400/415 V		
NS630b	3P	4P
	48967	48971
NS800	3P	4P
	48968	48972
Micrologic control units		
Without "measurement"		
Micrologic 2.0	basic protection	3P/4P
		33504
Micrologic 5.0	selective protection	3P/4P
		33511
Micrologic 6.0	selective + earth-fault protection	3P/4P
	"ammeter" A	33515
Micrologic 2.0 A	basic protection	3P/4P
		33525
Micrologic 5.0 A	selective protection	3P/4P
		33532
Micrologic 6.0 A	selective + earth-fault protection	3P/4P
		33533
Micrologic 7.0 A	selective + earth-leakage protection	3P/4P
	"energy" E ^[1]	33534
Micrologic 2.0 E	basic protection	3P/4P
		33536
Micrologic 5.0 E	selective protection	3P/4P
		33538
Micrologic 6.0 E	selective + earth-fault protection	3P/4P
	"power meter" P ^[1]	33540
Micrologic 5.0 P	selective protection	3P/4P
		65293
Micrologic 6.0 P	selective + earth-fault protection	3P/4P
		65294
Micrologic 7.0 P	selective + earth-leakage protection	3P/4P
		65295

[1] In case of an installation 3P + Neutral, please add ENVT device ref. 65316 (see page F-13).

Basic switch-disconnector

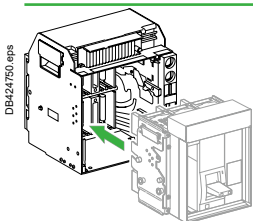

ComPact NS type NA		
NS630b	3P	4P
	33430	33431
NS800	3P	4P
	33432	33433
NS1000	3P	4P
	33434	33435
NS1250	3P	4P
	33436	33437
NS1600	3P	4P
	33438	33439

Basic chassis and connections

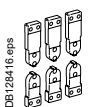
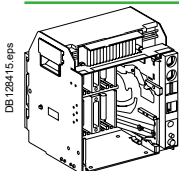

Chassis		
630-1250 A - NA/N/H	3P	4P
	33722	33725
1600 A - NA/N/H	3P	4P
	33723	33726
630/800 A - LB		
630-1000 A - L		
+ connection		
	3P	4P
Front connection		
Top NA/N/H/L/LB	3P	4P
	33727	33733
Bottom NA/N/H/L/LB	3P	4P
	33728	33734
Rear connection		
Vertical NA/N/H/L/LB	Top	3P
	Bottom	4P
		33729
		33735
Horizontal	Top	3P
	Bottom	4P
		33730
		33736
NA/N/H/L/LB	Top	3P
	Bottom	4P
		33731
		33737
		33732
		33738

Note: to order a complete device, order:

- a basic circuit breaker and a Micrologic control unit, or a basic switch disconnector.
- chassis and connections.
- accessories (for the device, the connection, the control unit) and communication option as required.

NS630b to NS1600 electrically operated withdrawable devices

Device based on separate components

Basic circuit breaker

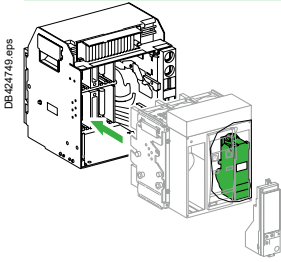

Note: the characteristics of the motor mechanism module for electrical operation are specified separately by selecting a part number from the table at the bottom of this page.

ComPact NS type N		
Icu = 50 kA at 220/415 V	3P	4P
NS630b	33370	33374
NS800	33380	33384
NS1000	33390	33394
NS1250	33400	33404
NS1600	33410	33414

ComPact NS type H		
Icu = 70 kA at 220/415 V	3P	4P
NS630b	33371	33375
NS800	33381	33385
NS1000	33391	33395
NS1250	33401	33405
NS1600	33411	33415

ComPact NS type L		
Icu = 150 kA at 220/415 V	3P	4P
NS630b	33372	33376
NS800	33382	33386
NS1000	33392	33396

Micrologic control units		
Without "measurement"		
		3P/4P
Micrologic 2.0	basic protection	33504
Micrologic 5.0	selective protection	33511
Micrologic 6.0	selective + earth-fault protection	33515
"ammeter" A		
		3P/4P
Micrologic 2.0 A	basic protection	33525
Micrologic 5.0 A	selective protection	33532
Micrologic 6.0 A	selective + earth-fault protection	33533
Micrologic 7.0 A	selective + earth-leakage protection	33534
"energy" E ^[1]		
		3P/4P
Micrologic 2.0 E	basic protection	33536
Micrologic 5.0 E	selective protection	33538
Micrologic 6.0 E	selective + earth-fault protection	33540
"power meter" P ^[1]		
		3P/4P
Micrologic 5.0 P	selective protection	65293
Micrologic 6.0 P	selective + earth-fault protection	65294
Micrologic 7.0 P	selective + earth-leakage protection	65295

[1] In case of an installation 3P + Neutral, please add ENVT device ref. 65316 (see page F-13).

Basic switch-disconnector

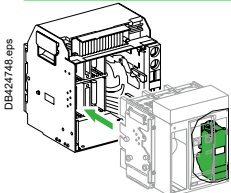

ComPact NS type NA		
	3P	4P
NS630b	33450	33451
NS800	33452	33453
NS1000	33454	33455
NS1250	33456	33457
NS1600	33458	33459

Note: the characteristics of the motor mechanism module for electrical operation are specified separately by selecting a part number from the table at the bottom of this page.

Chassis and connections

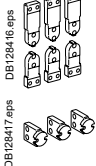
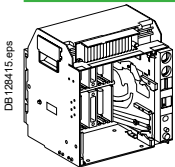

Chassis			
	3P	4P	
630-1250 A - NA/N/H	33722	33725	
1600 A - NA/N/H	33723	33726	
630-1000 A - L			
+ connection			
	3P	4P	
Front connection			
Top NA/N/H/L	33727	33733	
Bottom NA/N/H/L	33728	33734	
Rear connection			
Vertical NA/N/H/L	Top	33729	33735
	Bottom	33730	33736
Horizontal	Top	33731	33737
NA/N/H/L	Bottom	33732	33738

Motor mechanism module

	AC 50/60 Hz		DC		
	Standard	Communicating	Standard	Communicating	
48 V	33831 ^[2]	33838 ^[2]	24/30 V	33830 ^[2]	33837 ^[2]
100/130 V	33827 ^[2]	33834 ^[2]	48/60 V	33831 ^[2]	33838 ^[2]
220/240 V	33828 ^[2]	33835 ^[2]	100/130 V	33832 ^[2]	33839 ^[2]
380/415 V	33829 ^[2]	33836 ^[2]	200/250 V	33833 ^[2]	33840 ^[2]

Note: to order a complete device, order:
 ■ a basic circuit breaker and a Micrologic control unit, or a basic switch disconnector. ■ chassis and connections.
 ■ accessories (for the device, the connection, the control unit) and communication option as required.
[2] Consult us.











Accessories for NS630b to NS1600 fixed devices

Connection accessories

Front connection

Rear connection

Bare-cable connectors + 1 connector shield for 4 cables (240 mm ²)		3P (3 parts) 4P (4 parts)	33640 33641	
	1 long connection shield	3P 4P	33628 33629	
	Vertical-connection adapters	3P (3 parts) 4P (4 parts)	33642 33643	
	Cable lug adapters	3P (3 parts) 4P (4 parts)	33644 33645	33644 33645
	Cable lug kits	240 mm ² 300 mm ²	3P (6 lug kit) 4P (8 lug kit) 3P (6 lug kit) 4P (8 lug kit)	33013 33014 33015 33016
	Interphase barriers	3P/4P top (3 parts) 3P/4P bottom (3 parts)	33646 33646	33648 33648
	Arc chute screen	3P 4P	64907 33597	
	Brackets for mounting on a horizontal surface	3P/4P (2 parts)		64908
	Spreaders	3P 4P	33622 33623	33622 33623

Electrical auxiliaries



Indication contacts

	OF, ON/OFF indication contacts	6 A - 240 V	Low level
	SD, trip indication contact for manually operated devices	33108	33109
	SDE, fault indication contact operated devices	33004	33008
		33011	33012
	Up to 3 OF, 1 SD and 1 SDE can be connected (the SDE contact is standard for electrically operated devices).		







Instantaneous voltage releases

	MX	MN	Delay unit	R (non-adjustable)	Rr (adjustable)
	12 V DC	33658			
	24/30 V DC, 24 V AC	33659			
	48/60 V DC, 48 V AC	33660			
	100/130 V AC/DC	33661	48/60 V AC/DC		33680
	200/250 V AC/DC	33662	100/130 V AC/DC	33684	33681
	277 V AC	33663	200/250 V AC/DC	33685	33682
	380/480 V AC	33664	380/480 V AC/DC		33683

Installation accessories

	Escutcheon (small cut-out) for manually operated device with toggle	33717
	Escutcheon for: device with toggle (large cut-out), - device with rotary handle, - electrically operated device	33718
ref. 33717		
ref. 33718		
Blanking plate		33858
		

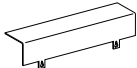
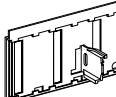
Accessories for NS630b to NS1600 withdrawable devices

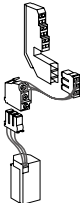
Connection accessories		Front connection	Rear connection				
Vertical-connection adapters							
DB128422.eps 	3P (3 parts)	33642					
	4P (4 parts)	33643					
Cable lug adapters							
DB128423.eps 	3P (3 parts)	33644	33644				
	4P (4 parts)	33645	33645				
Cable lug kits							
DB128424.eps 	240 mm ²	3P (6 lug kit)	33013				
		4P (8 lug kit)	33014				
	300 mm ²	3P (6 lug kit)	33015				
		4P (8 lug kit)	33016				
Interphase barriers							
DB128433.eps 		3P/4P (3 parts)	33768				
Spreaders							
DB128427.eps 		3P (3 parts)	33622				
		4P (4 parts)	33623				
Chassis accessories							
Auxiliary terminal shield (CB)							
DB128434.eps 		3P	33763				
		4P	33764				
Safety shutters (VO) as standard							
DB128435.eps 		3P	33765				
		4P	33766				
Electrical auxiliaries							
OF ON/OFF indication contacts							
DB128436.eps 		6 A - 240 V	Low level				
	OF, ON/OFF indication contacts	33801	33804				
	SD, trip indication contact for manually operated devices	33800	33803				
	SDE, fault indication contact operated devices	33799	33802				
	Up to 3 OF, 1 SD and 1 SDE can be connected (the SDE contact is standard for electrically operated devices)						
CE, CD, CT carriage switches							
DB128437.eps 		6 A - 240 V	Low level				
	Connected position NO/NC contact (up to 3 CE)	33751	33754				
	Disconnected position NO/NC (up to 2 CD)	33753	33756				
	Test position NO/NC contact (up to 1 CT)	33752	33755				
	Spare parts (up to 3 CE, 1 CT, 2 CD per device)	33170	33171				
Instantaneous voltage releases							
DB128438.eps 		MX	MN	Delay unit	R (non-adjustable)	Rr (adjustable)	
	12 V DC	33809					
	24/30 V DC, 24 V AC	33810	33819				
	48/60 V DC, 48 V AC	33811	33820	48/60 V AC/DC		33680	
	100/130 V AC/DC	33812	33821	100/130 V AC/DC	33684	33681	
	200/250 V AC/DC	33813	33822	200/250 V AC/DC	33685	33682	
	277 V AC	33814					
	380/480 V AC	33815	33824	380/480 V AC/DC		33683	
Auxiliary terminals for chassis alone							
						3 wire terminal (30 parts)	47071
						6 wire terminal (10 parts)	47072
						Jumpers (10 parts)	47900



Accessories for NS630b to NS1600 withdrawable devices

Chassis locking

Keylocking in disconnected position

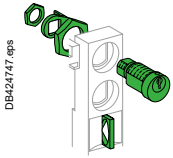

By Profalux keylocks

Profalux	1 lock with 1 key + adaptation kit	64909
	2 locks 1 key + adaptation kit	64910
	2 locks 2 different keys + adaptation kit	64911
1 keylock Profalux (without adaptation kit):		
	identical key not identified combination	33173
	identical key identified 215470 combination	33174
	identical key identified 215471 combination	33175

By Ronis keylocks

Ronis	1 lock with 1 key + adaptation kit	64912
	2 locks 1 key + adaptation kit	64913
	2 locks 2 different keys + adaptation kit	64914
1 keylock Ronis (without adaptation kit):		
	identical key not identified combination	33189
	identical key identified EL24135 combination	33190
	identical key identified EL24153 combination	33191
	identical key identified EL24315 combination	33192
Optional disconnected/test/connected position locking		33779
Adaptation kit (without keylock):		
	adaptation kit Profalux	33769
	adaptation kit Ronis	33770
	adaptation kit Castell	33771
	adaptation kit Kirk	33772

Door interlock

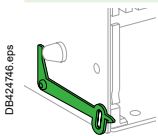

Right side of chassis (VPECD)	33786
Left side of chassis (VPECG)	33787

Racking interlock (VPOC)

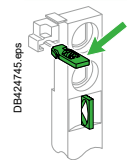

	33788
--	--------------

Mismatch protection (VDC)



	33767
--	--------------

Installation accessories

Escutcheon

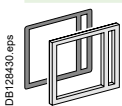

	33857
--	--------------

Transparent cover for escutcheon



	33859
--	--------------

Blanking plate

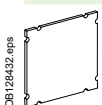

	33858
--	--------------

Accessories for NS630b to NS1600 fixed and withdrawable devices

Locking for manually operated devices

Removable toggle locking system

	Locking by 3 padlocks	44936
---	-----------------------	--------------

Fixed toggle locking system

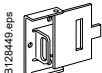
	Locking by 3 padlocks	32631
---	-----------------------	--------------

Rotary handle for manually operated devices

Devices with direct rotary handles

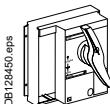
	Handle and front	Black handle and black front	33863	
		Red handle and yellow front	33864	
	Conversion accessory	CNOMO	33866	
	Locking by keylocks		Ronis	Profalux
		OFF position	33870	33869
		OFF and ON positions	33872	33871
Keylock kit (without keylocks)		33868	33868	

Mechanical interlocking

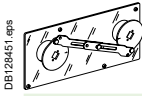
	For 2 devices with extended rotary handles	33890
---	--	--------------

Devices with extended rotary handles

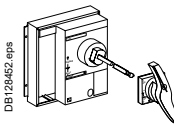
	Handle and front	Black handle and black front	33878
		Red handle and yellow front	33879
		Telescopic (for chassis-mounted devices)	33880
	Control accessories		

Control accessories

	2 advanced indication contacts (6 A - 240 V)		Fixed	Withdrawable
		Early break	33882	33884
		Early make	33883	33885

Locking and accessories for electrically operated devices

Pushbutton locking

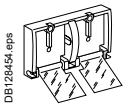
	By transparent cover + padlocks	33897
---	---------------------------------	--------------

Locking in OFF position

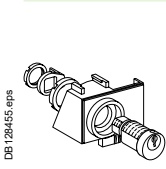
	By padlocks + BPFE support		
	VCPO	47514	
	By Profalux keylocks		
	Profalux	1 lock with 1 key + adaptation kit	33902
		2 locks 1 key + adaptation kit	33904
	1 keylock Profalux (without adaptation kit):		
		identical key not identified combination	33173
		identical key identified 215470 combination	33174
		identical key identified 215471 combination	33175
	By Ronis keylocks + BPFE support		
	Ronis	1 lock with 1 key + adaptation kit	33903
		2 locks 1 key + adaptation kit	33905
	1 keylock Ronis (without adaptation kit):		
		identical key not identified combination	33189
		identical key identified EL24135 combination	33190
	identical key identified EL24153 combination	33191	
	identical key identified EL24315 combination	33192	
Adaptation kit (without keylock):			
	adaptation kit Profalux	33898	
	adaptation kit Ronis	33899	
	adaptation kit Kirk	47517	
	adaptation kit Castell	47518	

Operation counter CDM

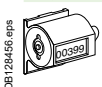
	Operation counter CDM	33895
---	-----------------------	--------------



Catalogue numbers

Accessories for NS630b to 1600 fixed and withdrawable devices

Mechanical interlocking

Mechanical interlocking for source changeover

Interlocking using connecting rods for ComPact electrically operated devices

DB128465.eps



Complete assembly with 2 adaptation fixtures + rods	33910
2 ComPact fixed devices	
2 ComPact withdrawable devices	33913

DB17641.eps



Interlocking using cables for ComPact electrically operated devices

DB17641.eps

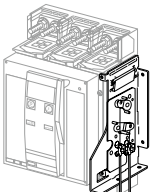

Complete assembly with 2 adaptation fixtures + cables	
2 ComPact fixed devices	33911
2 ComPact withdrawable devices	33914
1 ComPact fixed + 1 ComPact withdrawable device	33915

Communication option for NS630b to NS1600 fixed and withdrawable devices

Communication options

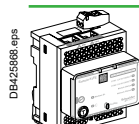
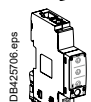
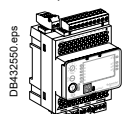
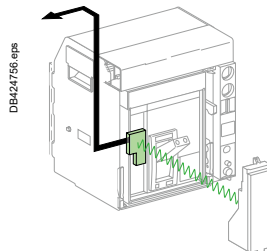
	IFE	Ethernet interface for LV breaker	LV434001
		Ethernet interface for LV breakers and gateway	LV434002
		IFM Modbus-SL interface module	LV434000
		I/O application module	LV434063
	For fixed devices		
		Manually operated	Electrically operated
	COM (BCM-ULP)	33702	33708
	Eco COM module (BCM-ULP)	33703	33709
	For drawout devices		
	Breaker + chassis		
	Manually operated	Electrically operated	
COM (BCM-ULP)	33842	33848	
Eco COM module (BCM-ULP)	33714	33713	

Accessories for Micrologic control units

Long-time rating plug (enhanced accuracy by limiting the setting range)

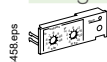
	Standard	0.4 to 1 x lr	33542
	Low setting	0.4 to 0.8 x lr	33543
	High setting	0.8 to 1 x lr	33544
	Without long-time protection	OFF	33545

External Neutral Voltage Tap

For Micrologic E and P - 3P + Neutral installation

Connection kit to neutral for Micrologic P on fixed version	65317
Connection kit to neutral for Micrologic P on drawout version	65316

External sensors

External sensor for neutral + earth-fault protection (TCE)

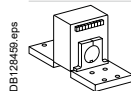
	CT rating: 400/1600 A	33576
---	-----------------------	--------------

Rectangular sensor for earth-leakage protection

	Inside dimensions (mm)	le (A)	
	280 x 115	1600	33573

Source ground return (SGR) earth fault protection

	External sensor (SGR)	33579
	MDGF summing module	48891

External power supply module (AD)

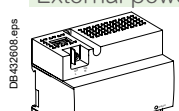
	24/30 V DC	LV454440
	48/60 V DC	LV454441
	100/125 V DC	LV454442
	110/130 V AC	LV454443
	200/240 V AC	LV454444

Test equipment

Mini test kit

	Hand held test kit (HHTK)	33594
---	---------------------------	--------------

Portable test kit

	Full function test kit (FFTK)	33595
	Test report edition come from FFTK	34559
	FFTK test cable 2 pin for STR trip unit	34560
	FFTK test cable 7 pin for Micrologic trip unit	33590



NS1600b to NS3200 fixed, front-connected, manually operated device

Circuit breaker

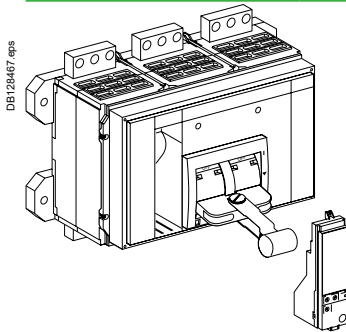

ComPact NS type N		
Icu = 85/70 kA to 220/415 V	3P	4P
NS1600b	34000	34003
NS2000	34006	34009
NS2500	34012	34015
NS3200	34018	34021
ComPact NS type H		
Icu = 125/85 kA to 220/415 V	3P	4P
NS1600b	34001	34004
NS2000	34007	34010
NS2500	34013	34016
NS3200	34019	34022
Micrologic control units		
Without "measurement"		
		3P/4P
Micrologic 2.0	basic protection	33504
Micrologic 5.0	selective protection	33511
Micrologic 6.0	selective + earth-fault protection	33515
"ammeter" A		
		3P/4P
Micrologic 2.0 A	basic protection	33505
Micrologic 5.0 A	selective protection	33512
Micrologic 6.0 A	selective + earth-fault protection	33513
Micrologic 7.0 A	selective + earth-leakage protection	33514
"energy" E		
		3P/4P
Micrologic 2.0 E	basic protection	33535
Micrologic 5.0 E	selective protection	33537
Micrologic 6.0 E	selective + earth-fault protection	33539

Switch-disconnector

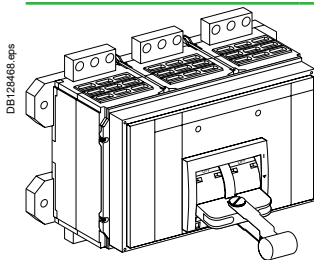

ComPact NS type NA		
	3P	4P
NS1600b	34024	34025
NS2000	34027	34028
NS2500	34030	34031
NS3200	34033	34034

Optional vertical connection adaptor

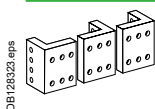

1600/2500 A	3P (3 parts)	33975
	4P (4 parts)	33976
Note: standard for 3200 A.		

Electrical auxiliaries

Indication contacts



OF, ON/OFF indication contacts	6 A - 240 V	Low level
SD, trip indication contact for manually operated devices	33108	33109
SDE, fault indication contact operated devices	33004	33008
Up to 3 OF, 1 SD and 1 SDE can be connected	33011	33012

Instantaneous voltage releases

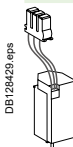

	MX	MN	Delay unit	R (non-adjustable)	Rr (adjustable)
12 V DC	33658				
24/30 V DC, 24 V AC	33659	33668			
48/60 V DC, 48 V AC	33660	33669	48/60 V AC/DC		33680
100/130 V AC/DC	33661	33670	100/130 V AC/DC	33684	33681
200/250 V AC/DC	33662	33671	200/250 V AC/DC	33685	33682
277 V AC	33663				
380/480 V AC	33664	33673	380/480 V AC/DC		33683

Locking

Removable toggle locking system



Locking by 3 padlocks	33996
-----------------------	-------

Fixed toggle locking system

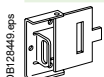

Locking by 3 padlocks	32631
-----------------------	-------

Accessories for NS1600b to NS3200

Communication option

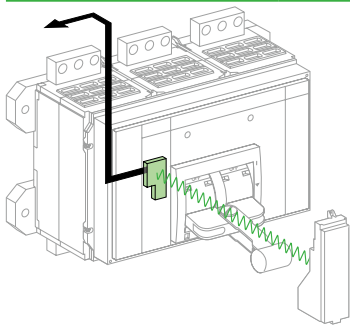
 <p>DB424755.eps</p>	IFE	Ethernet interface for LV breaker	LV434001
		Ethernet interface for LV breakers and gateway	LV434002
		IFM Modbus-SL interface module	LV434000
		I/O application module	LV434063
		COM (BCM-ULP)	33986
	Eco COM module (BCM-ULP)	33988	

Accessories for Micrologic control units

Long-time rating plug (enhanced accuracy by limiting the setting range)

 <p>DB128483.eps</p>	Standard	0.4 to 1 x Ir	33542
	Low setting	0.4 to 0.8 x Ir	33543
	High setting	0.8 to 1 x Ir	33544
	Without long-time protection	OFF	33545

External sensors

External sensor for neutral + earth-fault protection (TCE)

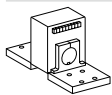
 <p>DB128489.eps</p>	CT rating: 1000/4000 A	34036
--	------------------------	-------

Rectangular sensor for earth-leakage protection

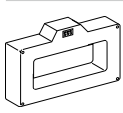
 <p>DB128100.eps</p>	470 mm x 160 mm	33574
---	-----------------	-------

Source ground return (SGR) earth fault protection

 <p>DB128480.eps</p>	External sensor (SGR)	33579
	MDGF summing module	48891

External power supply module (AD)

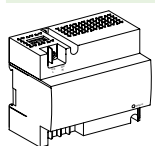
 <p>DB432828.eps</p>	24/30 V DC	LV454440
	48/60 V DC	LV454441
	100/125 V DC	LV454442
	110/130 V AC	LV454443
	200/240 V AC	LV454444

Test equipment

Mini test kit

 <p>DB128463.eps</p>	Hand held test kit (HHTK)	33594
---	---------------------------	-------

Portable test kit

 <p>DB128464.eps</p>	Full function test kit (FFTK)	33595
	Test report edition come from FFTK	34559
	FFTK test cable 2 pin for STR trip unit	34560
	FFTK test cable 7 pin for Micrologic trip unit	33590

Installation accessories

Escutcheon

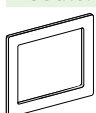
 <p>DB128444.eps</p>	33929
---	-------

Interphase barriers (3 parts)

 <p>DB128446.eps</p>	33998
---	-------







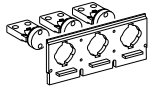



Spare parts: NS630b to NS1600 fixed circuit breaker Connection

Connections for circuit breakers and switch-disconnectors

	Front connection / Replacement kit (3 or 4 parts)			
	630/1000 A - N	Top	3P 33598	33608
		Bottom	33599	33609
	1250 A - N	Top	33600	33610
		Bottom	33601	33611
	630/800 A - LB			
	1600 A - N	Top	33602	33612
Bottom		33603	33613	
Rear connection / Replacement kit (3 or 4 parts)				
	Vertical and horizontal (top or bottom)		3P 33584	4P 33585
	Installation manual		33148	

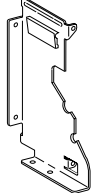
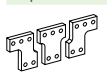
Connection accessories

Bare-cable connectors + 1 connector shield for 4 cables (240 mm ²)			
	3P		33640
	4P		33641
	Installation manual		33148
1 long connection shield / 1 part			
	3P		33628
	4P		33629
Vertical-connection adapters / Replacement kit (3 or 4 parts)			
	3P		33642
	4P		33643
	Installation manual		33148
Cable lug adapters / Replacement kit (3 or 4 parts)			
	3P		33644
	4P		33645
	Installation manual		33148
Interphase barriers / Replacement kit (3 parts)			
	3P/4P top/bottom		33646
	Installation manual		33148
	3P/4P top/bottom		33648
	Installation manual		33148
Arc chute screen / 1 part			
	3P		64907
	4P		33597
	Installation manual		33148
Brackets for mounting on a horizontal surface (2 parts)			
	3P/4P		64908
Spreaders / Replacement kit (3 or 4 parts)			
	3P		33622
	4P		33623
	Installation manual		33148
Cable lug kits / Replacement kit (6 or 8 parts)			
	240 mm ²	3P (6 lug kit)	33013
		4P (8 lug kit)	33014
	300 mm ²	3P (6 lug kit)	33015
		4P (8 lug kit)	33016
	Installation manual		33148

F

Spare parts: NS630b to NS1600 fixed circuit breaker

Electrical auxiliaries and installation accessories

Electrical auxiliaries

Indication contact / 1 part

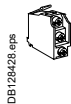

OF, ON/OFF indication contacts	6 A - 240 V	Low level
SD trip indication contact for manually operated devices	29450	29452
SDE fault indication contact operated devices	29450	29452
Up to 3 OF, 1 SD and 1 SDE can be connected (the SDE contact is standard for electrically operated devices).		
Installation manual		33148

Remote tripping / 1 part

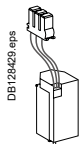

	MX	MN	Delay unit	R (non-adjustable)	Rr (adjustable)
12 V DC	33658				
24/30 V DC, 24 V AC	33659	33668			
48/60 V DC, 48 V AC	33660	33669	48/60 V AC/DC		33680
100/130 V AC/DC	33661	33670	100/130 V AC/DC	33684	33681
200/250 V AC/DC	33662	33671	200/250 V AC/DC	33685	33682
277 V AC	33663				
380/480 V AC	33664	33673	380/480 V AC/DC		33683
Installation manual	33149				

Installation accessories / 1 part



Escutcheon (small cut-out) for manually operated device with toggle	33717
---	--------------

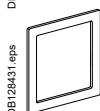

Escutcheon for:	33718
- device with toggle (large cutout)	
- device with rotary handle	
- electrically operated device	

Blanking plate / 1 part

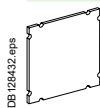

Blanking plate	33858
----------------	--------------

Installation manual	33148
---------------------	--------------

Toggle extension / 1 part



Toggle extension	46996
------------------	--------------

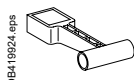

Additional toggle extension	33195
-----------------------------	--------------



Spare parts: NS630b to NS1600 fixed circuit breaker

Micrologic control unit, external sensor

Replacement parts for Micrologic control units



Long-time rating plug (limits setting range for higher accuracy) / 1 part

	Standard	0.4 at 1 x Ir	33542
	Low-setting option	0.4 at 0.8 x Ir	33543
	High-setting option	0.8 at 1 x Ir	33544
	Without long-time protection	off	33545

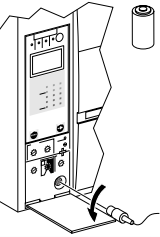
Battery + cover

	Battery (1 part)		33593
	Cover (1 part)	For Micrologic A, E	33592
		For Micrologic P	47067

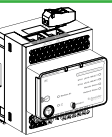
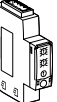
Communication option

	IFE	Ethernet interface for LV breaker	LV434001
		Ethernet interface for LV breakers and gateway	LV434002
	IFM Modbus-SL interface module		LV434000
	I/O application module		LV434063
	User guide IFE User guide I/O application module		DOCA0084EN-00
			DOCA0055EN-00

External sensors

External sensor for neutral + earth-fault protection (TCE) / 1 part

	CT rating: 400/1600 A	33576

Rectangular sensors

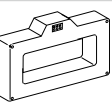
	Inside dimensions (mm)	le (A)	
	280 x 115	1600	33573

Source ground return (SGR) earth-fault protection / 1 part

	External sensor (SGR)	33579
	MDGF summing module	48891

External power supply module (AD) / 1 part

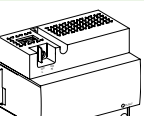
	24-30 V DC	LV454440
	48-60 V DC	LV454441
	100-125 V DC	LV454442
	110-130 V AC	LV454443
	200-240 V AC	LV454444

Test equipments / 1 part

	Hand held test kit (HHTK)	33594
	Full function test kit (FFTK)	33595
	Test report edition come from FFTK	34559
	FFTK test cable 2 pin for STR trip unit	34560
	FFTK test cable 7 pin for Micrologic trip unit	33590

F

Spare parts: NS630b to NS1600 fixed circuit breaker

Locking and accessories

Locking for manually operated devices

Removable toggle locking system / 1 part

DB128446.eps		Locking by 3 padlocks	44936
		Installation manual	33148

Fixed toggle locking system / 1 part

DB128449.eps		Locking by 3 padlocks	32631
		Installation manual	33148

Rotary handle for manually operated devices

Devices with direct rotary handles / 1 part

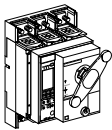
DB128352.eps		Conversion accessory	CNOMO	33866	
		Locking by keylocks		Ronis	Profalux
			OFF position	33870	33869
			OFF and ON positions	33872	33871
		Keylock kit (without keylocks)		33868	33868
		Installation manual		33150	

Mechanical interlocking



DB128451.eps		For 2 devices with extended rotary handles	33890
--------------	---	--	--------------

Locking and accessories for electrically operated devices

Pushbutton locking / 1 part

DB128454.eps		By transparent cover + padlocks	33897
		Installation manual	47103

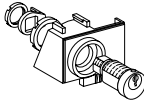
Locking in OFF position / 1 part

DB128455.eps		By padlocks + BPFE support		
		VCPO	47514	
		By Profalux keylocks		
		Profalux	1 lock with 1 key + adaptation kit	33902
			2 locks 1 key + adaptation kit	33904
		1 keylock Profalux (without adaptation kit):		
			identical key not identified combination	33173
			identical key identified 215470 combination	33174
			identical key identified 215471 combination	33175
		By Ronis keylocks		
		Ronis	1 lock with 1 key + adaptation kit	33903
			2 locks 1 key + adaptation kit	33905
		1 keylock Ronis (without adaptation kit):		
			identical key not identified combination	33189
			identical key identified EL24135 combination	33190
			identical key identified EL24153 combination	33191
			identical key identified EL24315 combination	33192
		Adaptation kit (without keylock):		
	adaptation kit Profalux	33898		
	adaptation kit Ronis	33899		
	adaptation kit Kirk	47517		
	adaptation kit Castell	47518		
	Installation manual	47103		
Operation counter CDM / 1 part				
DB128456.eps		Operation counter CDM	33895	
		Installation manual	47103	



Catalogue numbers

Spare parts: NS630b to NS1600 fixed and withdrawable circuit breaker

Mechanical interlocking for source changeover

Mechanical interlocking for source changeover

Interlocking using connecting rods for ComPact electrically operated devices

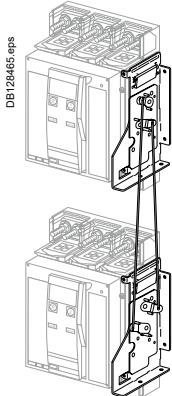

Complete assembly with 2 adaptation fixtures + rods
 2 ComPact fixed devices
Note: the installation manual is enclosed.

33910

Interlocking using cables for ComPact electrically operated devices

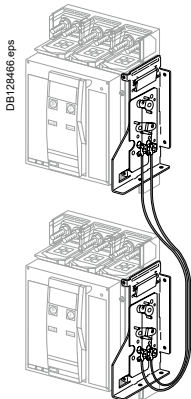

Complete assembly with 2 adaptation fixtures + cables
 2 ComPact fixed devices
 1 ComPact fixed + 1 ComPact withdrawable device
Note: the installation manual is enclosed.



33911

33915



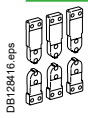

F

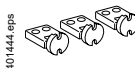
Spare parts: NS630b to NS1600 withdrawable circuit breaker Connection

Connection

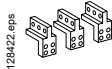
	Front connection / Replacement kit (6 or 8 parts)	3P	4P
	Top and bottom	33588	33589
	Rear connection / Replacement kit (4 or 6 parts) Vertical and horizontal	33586	33587
		33586	33587
	Vert. mounting.	Horiz. mounting.	Installation manual
			33149

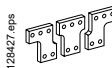
Connection accessories

	Vertical connection adapters for front-connected chassis / Replacement kit (3 or 4 parts)		
	3P	33642	
	4P	33643	
	Installation manual	33149	
	Cable lug adapters for front-connected chassis / Replacement kit (3 or 4 parts)		
	3P	33644	
	4P	33645	
	Installation manual	33149	
	Interphase barriers for rear-connected chassis / Replacement kit (3 parts)		
	3P/4P	33768	
	Installation manual	33149	
	Spreaders for front-connected and rear-connected chassis / Replacement kit (3 or 4 parts)		
	3P	33622	
	4P	33623	
	Installation manual	33149	
	Cable lug kits / Replacement kit (6 or 8 parts)		
	240 mm ²	3P (6 lug kit)	33013
		4P (8 lug kit)	33014
	300 mm ²	3P (6 lug kit)	33015
		4P (8 lug kit)	33016
	Installation manual	33149	

Chassis accessories

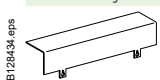
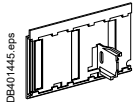
	Auxiliary terminal shield (CB) / 1 part	
	3P	33763
	4P	33764
	Installation manual	33149
	Safety shutters (VO) / 1 part	
	3P	33765
	4P	33766
	Installation manual	47104

Clusters

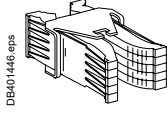
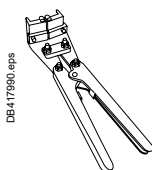
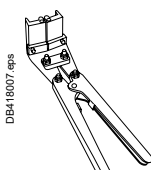
	1 disconnecting contact cluster for chassis (see table below) (1 part)		64906
	Table : number of clusters required for the different chassis models		
	Chassis rating (A)	ComPact NS - 3P	ComPact NS - 4P
		NA - N	L
	630	12	18
	800	12	18
	1000	12	18
	1250	12	16
	1600	18	24
	Note: the minimum order is 6 parts.		
		Set of 2 clusters fitters for 2 and 3 clusters	
		47554	



Spare parts: NS630b to NS1600 withdrawable circuit breaker Electrical auxiliaries

Electrical auxiliaries

SD trip indication contact for manually operated devices / 1 part

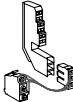
 DB128436.eps	OF, ON/OFF indication contacts	6 A - 240 V	Low level
		33801	33804
	SD trip indication contact for manually operated devices	33800	33803
	SDE fault indication contact operated devices	33799	33802
	Up to 3 OF, 1 SD and 1 SDE can be connected (the SDE contact is standard for electrically operated devices).		
Installation manual		47103	

CE, CD, CT carriage switches / 1 part

 DB128437.eps		6 A - 240 V	Low level
	Connected position NO/NC contact (up to 3 CE)	33751	33754
	Disconnected position NO/NC (up to 2 CD)	33753	33756
	Test position NO/NC contact (up to 1 CT)	33752	33755
	Spare parts (up to 3 CE, 1 CT, 2 CD per device)	33170	33171
Installation manual	47104		

Instantaneous voltage releases / 1 part

	MX	MN	Delay unit	R (non-adjustable)	Rr (adjustable)
12 V DC	33658				
24/30 V DC, 24 V AC	33659	33668			
48/60 V DC, 48 V AC	33660	33669	48/60 V AC/DC		33680
100/130 V AC/DC	33661	33670	100/130 V AC/DC	33684	33681
200/250 V AC/DC	33662	33671	200/250 V AC/DC	33685	33682
277 V AC	33663				
380/480 V AC	33664	33673	380/480 V AC/DC		33683
Installation manual	47103				

Auxiliaries terminal for chassis

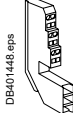
 DB 128354.eps 3 wires.	 DB401448.eps 6 wires.	3 wire terminal block (1 part)	33098
		6 wire terminal block (1 part)	33099
		Jumpers (10 parts)	47900
		Installation manual	47103

Spare parts: NS630b to NS1600 withdrawable circuit breaker Installation accessories

Installation accessories

Escutcheon / 1 part

33857

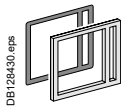

DB128430.eps

Transparent cover for escutcheon / 1 part

33859



DB128445.eps

Blanking plate / 1 part

33858

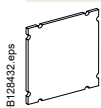

DB128452.eps



Catalogue numbers

Spare parts: NS630b to NS1600 withdrawable circuit breaker Micrologic control unit, external sensor

Replacement parts for Micrologic control units



Long-time rating plug (limits setting range for higher accuracy) / 1 part

	Standard	0.4 at 1 x I _r	33542
	Low-setting option	0.4 at 0.8 x I _r	33543
	High-setting option	0.8 at 1 x I _r	33544
	Without long-time protection	off	33545

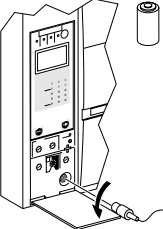
Battery + cover

	Battery (1 part)		33593
	Cover (1 part)	For Micrologic A, E	33592
		For Micrologic P	47067

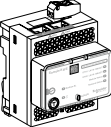
Communication option

	IFE	Ethernet interface for LV breaker	LV434001
		Ethernet interface for LV breakers and gateway	LV434002
	IFM Modbus-SL interface module		LV434000
	I/O application module		LV434063
	User guide IFE		DOCA0084EN-00
	User guide I/O application module		DOCA0055EN-00

External sensors

External sensor for neutral + earth-fault protection (TCE) / 1 part

	CT rating: 400/1600 A	33576
---	-----------------------	-------

Source ground return (SGR) earth-fault protection + Vigi cable / 1 part

	External sensor (SGR)	33579
	MDGF summing module	48891

Rectangular sensors

	Inside dimensions (mm)	I_e (A)	
	280 x 115	1600	33573

External power supply module (AD) / 1 part

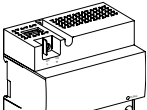
	24-30 V DC	LV454440
	48-60 V DC	LV454441
	100-125 V DC	LV454442
	110-130 V AC	LV454443
	200-240 V AC	LV454444

Test equipments / 1 part

	Hand held test kit (HHTK)	33594
	Full function test kit (FFTK)	33595
	Test report edition come from FFTK	34559
	FFTK test cable 2 pin for STR trip unit	34560
	FFTK test cable 7 pin for Micrologic trip unit	33590

Spare parts: NS630b to NS1600 withdrawable circuit breaker Locking and accessories

Locking for manually operated devices

Removable toggle locking system / 1 part

DB128448.eps

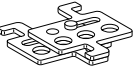

Locking by 3 padlocks	44936
Installation manual	33148

Fixed toggle locking system / 1 part

DB128449.eps



Locking by 3 padlocks	32631
Installation manual	33148

Rotary handle for manually operated devices

Devices with direct rotary handles / 1 part

DB128352.eps

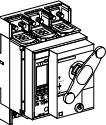

Conversion accessory	CNOMO	33866	
Locking by keylocks		Ronis	Profalux
	OFF position	33870	33869
	OFF and ON positions	33872	33871
Keylock kit (without keylocks)		33868	33868
Installation manual			33150

Mechanical interlocking

DB128451.eps

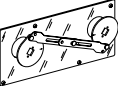

For 2 devices with extended rotary handles	33890
--	--------------

Locking and accessories for electrically operated devices

Pushbutton locking / 1 part

DB128454.eps

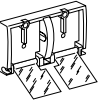

By transparent cover + padlocks	33897
Installation manual	47103

Locking in OFF position / 1 part

DB128455.eps

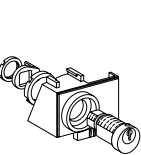

By padlocks + BPFE support			
VCPO			47514
By Profalux keylocks			
Profalux	1 lock with 1 key + adaptation kit		33902
	2 locks 1 key + adaptation kit		33904
1 keylock Profalux (without adaptation kit):			
	identical key not identified combination		33173
	identical key identified 215470 combination		33174
	identical key identified 215471 combination		33175
By Ronis keylocks			
Ronis	1 lock with 1 key + adaptation kit		33903
	2 locks 1 key + adaptation kit		33905
1 keylock Ronis (without adaptation kit):			
	identical key not identified combination		33189
	identical key identified EL24135 combination		33190
	identical key identified EL24153 combination		33191
	identical key identified EL24315 combination		33192
Adaptation kit (without keylock):			
	adaptation kit Profalux		33898
	adaptation kit Ronis		33899
	adaptation kit Kirk		47517
	adaptation kit Castell		47518
Installation manual			47103

Operation counter CDM / 1 part

DB128456.eps



Operation counter CDM / 1 part	33895
Installation manual	47103



Spare parts: NS630b to NS1600 withdrawable circuit breaker

Chassis locking and accessories Mechanical interlocking for source changeover

Chassis locking

Keylocking in disconnected position / 1 part

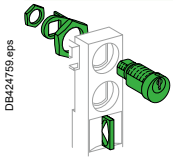

By Profalux keylocks

Profalux	1 lock with 1 key + adaptation kit	64909
	2 locks 1 key + adaptation kit	64910
	2 locks 2 different keys + adaptation kit	64911
1 keylock Profalux (without adaptation kit):	identical key not identified combination	33173
	identical key identified 215470 combination	33174
	identical key identified 215471 combination	33175

By Ronis keylocks

Ronis	1 lock with 1 key + adaptation kit	64912
	2 locks 1 key + adaptation kit	64913
	2 locks 2 different keys + adaptation kit	64914
1 keylock Ronis (without adaptation kit):	identical key not identified combination	33189
	identical key identified EL24135 combination	33190
	identical key identified EL24153 combination	33191
	identical key identified EL24315 combination	33192
Adaptation kit (without keylock):	adaptation kit Profalux	33769
	adaptation kit Ronis	33770
	adaptation kit Castell	33771
	adaptation kit Kirk	33772

Door interlock / 1 part

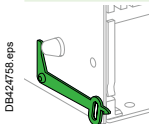

Right and left side of chassis (VPECD or VPECG)	33172
---	--------------

Installation manual	47104
---------------------	--------------

Racking interlock (VPOC) / 1 part

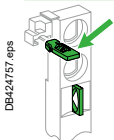

	33788
--	--------------

Installation manual	47104
---------------------	--------------

Mismatch protection (VDC) / 1 part



	33767
--	--------------

Installation manual	47104
---------------------	--------------

Mechanical interlocking for source changeover

Interlocking using connecting rods for ComPact electrically operated devices

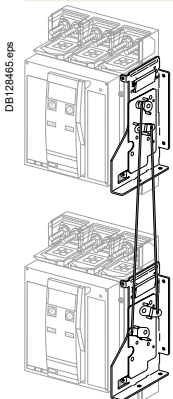

Complete assembly with 2 adaptation fixtures + rods	33913
---	--------------

2 ComPact withdrawable devices
Note: the installation manual is enclosed.

Interlocking using cables for ComPact electrically operated devices

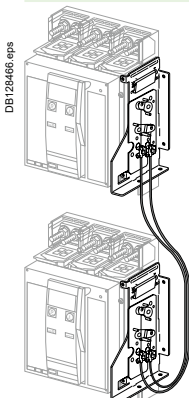

Complete assembly with 2 adaptation fixtures + cables	33914
---	--------------

2 ComPact fixed devices	33915
-------------------------	--------------

1 ComPact fixed + 1 ComPact withdrawable device
Note: the installation manual is enclosed.

F

Spare parts: NS630b to NS1600 fixed or withdrawable circuit breaker

Instructions

Instructions

Chassis accessories		47104
Circuit breaker accessories	Manual	33148
	Electrical	33149
Fixed and drawout circuit breaker	Manual	33148
	Electrical	33149
NS630b user manual	French	33159
	English	33160
Micrologic user manual	20/50 (French)	33076
	20/50 (English)	33077
	2A/7A (French)	33079
	2A/7A (English)	33080
	2E/6E (French)	33079
	2E/6E (English)	33080
	5P/7P (French)	33082
5P/7P (English)	33083	
Modbus communication notice for manual		33088

Spare parts: Communication bus accessories, monitoring and control, ethernet gateway

Communication options

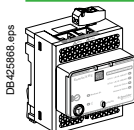
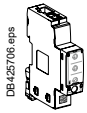
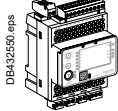
	IFE	Ethernet interface for LV breaker Ethernet interface for LV breakers and gateway	LV434001 LV434002
		IFM Modbus-SL interface module	LV434000
	I/O application module		LV434063

Monitoring and control



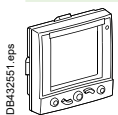

ULP display module ^[1]

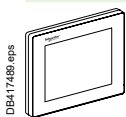
	Switchboard front display module FDM121		TRV00121
	FDM mounting accessory (diameter 22 mm)		TRV00128

Ethernet display module

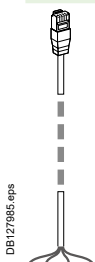
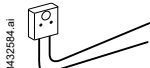
	Switchboard front display module FDM128		LV434128
---	---	--	----------

ULP wiring accessories

	Breaker ULP cord L = 0.35 m		LV434195
	Breaker ULP cord L = 1.3 m		LV434196
	Breaker ULP cord L = 3 m		LV434197
	Breaker ULP cord L = 5 m		LV434198
	10 Modbus line terminators		VW3A8306DRC ^[2]
	Connector Modbus adaptor		LV434211
	5 RJ45 connectors female/female		TRV00870
	10 ULP line terminators		TRV00880
	10 RJ45/RJ45 male cord L = 0.3 m		TRV00803
	10 RJ45/RJ45 male cord L = 0.6 m		TRV00806
	5 RJ45/RJ45 male cord L = 1 m		TRV00810
	5 RJ45/RJ45 male cord L = 2 m		TRV00820
	5 RJ45/RJ45 male cord L = 3 m		TRV00830
	1 RJ45/RJ45 male cord L = 5 m		TRV00850

[1] For measurement display with Micrologic A, E, P.

[2] www.schneider-electric.com.

F

Spare parts: ComPact NS1600b to 3200

Connection, locking and installation accessories

Optional vertical connection adaptor / Replacement kit (3 or 4 parts)

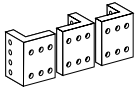
DB128323.eps		1600/2500/3200 A	3P	33975
			4P	33976
		Installation manual		33969

Electrical auxiliaries

Indication contacts (1 part)

DB128428.eps		OF, SD, SDE	6 A - 240 V	29450
			Low level	29452
		Note: up to 3 OF, 1 SD and 1 SDE can be connected.		
		Installation manual		33969

Instantaneous voltage releases (1 part)

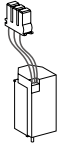
DB128429.eps			MX	MN	Delay unit	R (non-adjustable)	Rr (adjustable)
		12 V DC	33658				
		24/30 V DC, 24 V AC	33659	33668			
		48/60 V DC, 48 V AC	33660	33669	48/60 V AC/DC		33680
		100/130 V AC/DC	33661	33670	100/130 V AC/DC	33684	33681
		200/250 V AC/DC	33662	33671	200/250 V AC/DC	33685	33682
		277 V AC	33663				
		380/480 V AC	33664	33673	380/480 V AC/DC		33683
	Installation manual	33969					

Locking

Removable toggle locking system / 1 part

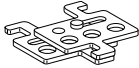
DB128448.eps		Locking by 3 padlocks	33996
		Installation manual	33969

Fixed toggle locking system / 1 part

DB128449.eps		Locking by 3 padlocks	32631
		Installation manual	33969

Installation accessories

Escutcheon / 1 part

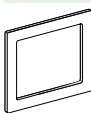
DB128444.eps		33929
--------------	---	-------

Interphase barriers / 3 parts

DB128446.eps		33998
		Installation manual

Toggle extension / 1 part

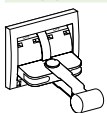
DB128339.eps		NS3200 toggle extension for replacement	33997
		Installation manual	33969



Catalogue numbers

Spare parts: ComPact NS1600b to 3200

Micrologic control unit, external sensor

Accessories for Micrologic control units

Long-time rating plug (enhanced accuracy by limiting the setting range) / 1 part

 DB128493.eps	Standard	0.4 to 1 x Ir	33542
	Low setting	0.4 to 0.8 x Ir	33543
	High setting	0.8 to 1 x Ir	33544
	Without long-time protection	OFF	33545

External sensors

External sensor for neutral + earth-fault protection (TCE) / 1 part

 DB128499.eps	CT rating: 1000/4000 A		34036
---	------------------------	--	-------

Source ground return (SGR) earth-fault protection + Vigi cable / 1 part

 DB128460.eps	External sensor (SGR)		33579
	MDGF summing module		48891

Rectangular sensors

	Inside dimensions (mm)	Ie (A)	
 DB128100.eps	470 x 160	3200	33574

External power supply module (AD) / 1 part

 DB428008.eps	24-30 V DC	LV454440
	48-60 V DC	LV454441
	100-125 V DC	LV454442
	110-130 V AC	LV454443
	200-240 V AC	LV454444

Test equipments / 1 part

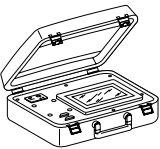
 DB128464.eps	Hand held test kit (HHTK)	33594
	Full function test kit (FFTK)	33595
	Test report edition come from FFTK	34559
	FFTK test cable 2 pin for STR trip unit	34560
	FFTK test cable 7 pin for Micrologic trip unit	33590

F

Order form: ComPact NS630b to NS3200

Circuit breakers and switch-disconnectors

Name of customer:
Address for delivery:
Requested delivery date:
Customer order no.:

To indicate your choices, check the applicable square boxes

and enter the appropriate information in the rectangles

Circuit breaker or switch-disconnector

ComPact type	NS630b to NS1600 NS1600b to NS3200	<input type="checkbox"/>
Rating	A	<input type="checkbox"/>
Circuit breaker	N, H, L, LB	<input type="checkbox"/>
Switch-disconnector	NA	<input type="checkbox"/>
Number of poles	3 or 4	<input type="checkbox"/>
Device	NS630b/3200 Fixed <input type="checkbox"/> NS630b/1600 Withdr. with chassis <input type="checkbox"/> Withdr. without chassis (moving part only) <input type="checkbox"/>	
Chassis alone without connections		<input type="checkbox"/>

Micrologic control unit

Basic protection	2.0 <input type="checkbox"/>	5.0 <input type="checkbox"/>	6.0 <input type="checkbox"/>	<input type="checkbox"/>
A - ammeter	2.0 <input type="checkbox"/>	5.0 <input type="checkbox"/>	6.0 <input type="checkbox"/>	7.0 <input type="checkbox"/>
E - energy	2.0 <input type="checkbox"/>	5.0 <input type="checkbox"/>	6.0 <input type="checkbox"/>	<input type="checkbox"/>
P - power	<input type="checkbox"/>	<input type="checkbox"/>	<input type="checkbox"/>	<input type="checkbox"/>
only for NS630b/1600	5.0 <input type="checkbox"/>	6.0 <input type="checkbox"/>	7.0 <input type="checkbox"/>	<input type="checkbox"/>
AD - external power-supply module	<input type="checkbox"/>	<input type="checkbox"/>	<input type="checkbox"/>	<input type="checkbox"/>
ENVT - External Neutral Voltage Tap (3P + N and Micrologic E or P)	<input type="checkbox"/>	<input type="checkbox"/>	<input type="checkbox"/>	<input type="checkbox"/>
TCE - external sensor (CT) for neutral protection	<input type="checkbox"/>	<input type="checkbox"/>	<input type="checkbox"/>	<input type="checkbox"/>
Rectangular sensor	NS630b/1600	280 x 115 mm	<input type="checkbox"/>	<input type="checkbox"/>
for earth-leakage protection	NS1600b/3200	470 x 160 mm	<input type="checkbox"/>	<input type="checkbox"/>
TCW - external sensor for SGR protection	<input type="checkbox"/>	<input type="checkbox"/>	<input type="checkbox"/>	<input type="checkbox"/>
LR - long-time rating plug	Standard 0.4 to 1 Ir <input type="checkbox"/> Low setting 0.4 to 0.8 Ir <input type="checkbox"/> High setting 0.8 to 1 Ir <input type="checkbox"/> LT OFF <input type="checkbox"/>			

Communication

COM module	
Device (BCM-ULP)	<input type="checkbox"/> with Ethernet interface <input type="checkbox"/> Cradle management with I/O application module (Chassis) <input type="checkbox"/>
	<input type="checkbox"/> with Ethernet interface + Gateway <input type="checkbox"/> I/O application module (Chassis) <input type="checkbox"/>
	<input type="checkbox"/> with Modbus interface <input type="checkbox"/>
Eco COM module	
Device (BCM-ULP)	<input type="checkbox"/> with Ethernet interface <input type="checkbox"/>
	<input type="checkbox"/> with Ethernet interface + Gateway <input type="checkbox"/>
	<input type="checkbox"/> with Modbus interface <input type="checkbox"/>

Front Display Module (FDM121)	<input type="checkbox"/>	Mounting accessories <input type="checkbox"/>
Breaker ULP Cord	L = 0.35 m <input type="checkbox"/> L = 1.3 m <input type="checkbox"/> L = 3 m <input type="checkbox"/> L = 5 m <input type="checkbox"/>	

NS630b/1600 connection

Horizontal rear connections	Top <input type="checkbox"/>	Bottom <input type="checkbox"/>
Vertical rear connections	Top <input type="checkbox"/>	Bottom <input type="checkbox"/>
Front connections	Top <input type="checkbox"/>	Bottom <input type="checkbox"/>
4 x 240 ² bare cable connectors + shields	NS - FC fixed <input type="checkbox"/>	
Long connection shields	NS - FC fixed <input type="checkbox"/>	
Vertical-connection adapters	NS - FC fixed, withdr. <input type="checkbox"/>	
Cable-lug adapters	NS - FC fixed, withdr. <input type="checkbox"/>	
Arc chute screen	NS - FC fixed <input type="checkbox"/>	
Interphase barriers	NS - FC fixed, withdrawable <input type="checkbox"/>	
Spreaders	NS - FC fixed, withdrawable <input type="checkbox"/>	

NS1600b/3200 connection

Front connections	NS - FC fixed <input type="checkbox"/>
Vertical connection adaptor	optional for NS1600b/2500 (standard for NS3200) <input type="checkbox"/>

Indication contacts

NS630b/3200	SD trip indication (maximum 1) (only for manually operated devices)	6 A-240 V AC	qty	<input type="checkbox"/>	Low level	qty	<input type="checkbox"/>
	SDE fault-trip indication (maximum 1) (SDE integrated in electrically operated devices)	6 A-240 V AC	qty	<input type="checkbox"/>	Low level	qty	<input type="checkbox"/>
	OF ON/OFF indication contacts (maximum 3)	6 A-240 V AC	qty	<input type="checkbox"/>	Low level	qty	<input type="checkbox"/>
NS630b/1600	Carriage switches (possible combinations: 3 CE, 2 CD, 1 CT)	6 A-240 V AC	qty	<input type="checkbox"/>	Low level	qty	<input type="checkbox"/>
	CE - "connected" position	6 A-240 V AC	qty	<input type="checkbox"/>	Low level	qty	<input type="checkbox"/>
	CD - "disconnected" position	6 A-240 V AC	qty	<input type="checkbox"/>	Low level	qty	<input type="checkbox"/>
	CT - "test" position	6 A-240 V AC	qty	<input type="checkbox"/>	Low level	qty	<input type="checkbox"/>
	I/O application module			<input type="checkbox"/>			<input type="checkbox"/>

Auxiliary terminals for chassis alone	Jumpers (set of 10)	<input type="checkbox"/>
3-wire terminal (30 parts)	6-wire terminal (10 parts)	<input type="checkbox"/>

Remote operation

Electrical operation (NS630b/1600)	Standard <input type="checkbox"/>	Communicating <input type="checkbox"/>
Power supply	AC <input type="checkbox"/>	DC <input type="checkbox"/>
Voltage releases	MX AC <input type="checkbox"/>	DC V <input type="checkbox"/>
	MN AC <input type="checkbox"/>	DC V <input type="checkbox"/>
MN delay unit	Ajustable <input type="checkbox"/>	Non ajustable <input type="checkbox"/>

Rotary handles for NS630b/1600 fixed and withdrawable device

Direct	Black <input type="checkbox"/>	Red on yellow front CNOMO conversion access. <input type="checkbox"/>
Extended	Black <input type="checkbox"/>	Red on yellow front Telescopic handle for withdrawable device <input type="checkbox"/>
Indication auxiliary	6 A-240 V AC <input type="checkbox"/>	2 early-make switches <input type="checkbox"/> 2 early-break switches <input type="checkbox"/>

Locking

Toggle (1 to 3 padlocks)	Removable system <input type="checkbox"/>	Fixed system <input type="checkbox"/>
Rotary handle using a keylock (NS630b/1600)	OFF position <input type="checkbox"/>	ON and OFF positions <input type="checkbox"/>
	Ronis 1351B.500 <input type="checkbox"/>	Profalux KS5 B24 D4Z <input type="checkbox"/>
	Keylock kit (without keylock) <input type="checkbox"/>	
For electrically operated devices (NS630b/1600)	VBP - ON/OFF pushbutton locking (by transparent cover +padlocks)	<input type="checkbox"/>
	OFF position locking: VCPO - by padlocks <input type="checkbox"/>	
	VSPO - by keylocks:	
	Keylock kit (w/o keylock)	Profalux <input type="checkbox"/>
	1 keylock	Profalux <input type="checkbox"/>
	2 identical keylocks, 1 key	Profalux <input type="checkbox"/>
	Keylock kit (w/o keylock)	Profalux <input type="checkbox"/>
Chassis locking in "disconnected" position:		
VSPD - by keylocks	Keylock kit (w/o keylock)	Profalux <input type="checkbox"/>
	1 keylock	Kirk <input type="checkbox"/>
	2 identical keylocks, 1 key	Profalux <input type="checkbox"/>
	2 keylocks, different keys	Profalux <input type="checkbox"/>
	Optional connected/disconnected/test position locking	
VPEC - door interlock		On right-hand side of chassis <input type="checkbox"/> On left-hand side of chassis <input type="checkbox"/>
VPOC - racking interlock		<input type="checkbox"/>
VDC - mismatch protection		<input type="checkbox"/>

Accessories

VO - safety shutters on chassis	NS - withdrawable as standard <input type="checkbox"/>
CDM - mechanical operation counter	<input type="checkbox"/>
CDP - escutcheon	<input type="checkbox"/>
CP - transparent cover for escutcheon	<input type="checkbox"/>
OP - blanking plate for escutcheon	<input type="checkbox"/>
Mounting brackets for fixed NS	for mounting on horizontal plane <input type="checkbox"/>
Test kits	Mini test kit <input type="checkbox"/> Portable test kit <input type="checkbox"/>

Micrologic control unit functions:

- 2.0: basic protection (long time + inst.)
- 5.0: selective protection (long time + short time + inst.)
- 6.0: selective + earth-fault protection (long time + short time + inst. + earth-fault)
- 7.0: selective + earth-leakage protection (long time + short time + inst. + earth-leakage)

Life Is On | **Schneider**
Electric

Schneider Electric Industries SAS

35, rue Joseph Monier
CS 30323
92506 Rueil Malmaison Cedex
France

RCS Nanterre 954 503 439
Capital social 928 298 512 €
www.se.com

Aug-2020
ART. 960551

© 2019 - Schneider Electric. All Rights Reserved.
All trademarks are owned by Schneider Electric Industries SAS or its affiliated companies.
Document reference: LVPED211021EN

This document has been
printed on recycled paper

