

Unified Controller

nv Series

Ethernet (EN811) Module

Instruction Manual

Notes

- (1) The technical information provided herein describes typical operations and applications of the product and does not guarantee the intellectual property rights or other rights of Toshiba or third parties nor allows license of its use.
- (2) No part or the whole of this document may be reproduced without prior consent.
- (3) The information herein may be changed in the future without notice.
- (4) All possible measures have been taken to prepare the information herein. If you have any question, comment, or find any error, please contact us.

PROSEC, TOSLINE, TOSDIC, CIEMAC are trademarks or registered trademarks of Toshiba Corporation.

IBM is a registered trademark of International Business Machines Corporation.

Microsoft, Windows are registered trademarks of Microsoft Corporation in the U.S. and other countries.

DeviceNet is a registered trademark of Open DevixeNet Vender Association Inc.

© TOSHIBA CORPORATION 2008



All rights reserved

Safety Precautions

On the product and this operation manual, important information for safe and correct use to prevent danger to the user and other people as well as property damage is described.

Understand the following information (signs and symbols) before reading the text, and follow the described items.

Description of signs







Sign	Description
 DANGER	Indicates that failure to avoid it will result in an immediate risk of death or serious injury ^(*1) .
 WARNING	Indicates that failure to avoid it will result in a risk of death or serious injury ^(*1) .
 CAUTION	Indicates that failure to avoid it will result in a risk of light or medium injury ^(*2) or only property damage ^(*3) .

*1: A serious injury indicates loss of sight, injury, burns (high/low temperature), electric shock, broken bones, or intoxication that will have aftereffects and require hospitalization or long-term hospital visits for healing.

*2: An injury indicates an injury, burn, or electric shock that does not need hospitalization or long-term hospital visits for healing.

*3: A property damage indicates consequential damage in terms of breakage of properties or materials.

Description of symbols

Symbol	Meaning
 Prohibited	Indicates "Prohibition" or "You must not do". Specific details are indicated near the symbol  with pictures and text.
 Mandatory	Indicates "Mandatory Action" or "Do as indicated". Specific details are indicated near the symbol  with pictures and text.
 Warning	Indicates Warning. Specific details are indicated near the symbol  with pictures and text.

(Note) Descriptions of Prohibition, Mandatory Action, and Warning vary depending on the display on the main unit.

1. Safety precautions on installation

WARNING



Ground

Ground the device.
Otherwise, it may cause an electric shock or fire.

CAUTION



Prohibited

Do not install, store, or use it in the following environments.

- A place with a lot of dust
 - A place with corrosive gases (SO₂, H₂S) or flammable gases
 - A place with vibrations and shocks exceeding the allowed values
 - A place with condensations due to rapid temperature changes
 - A place with low or high temperature outside of the installation condition
 - A place with high humidity outside of the installation condition
 - A place with direct sunlight
 - A place near equipment generating strong radio waves or magnetic fields
- It may cause accidents.



Prohibited

Do not block the ventilation hole or air inlet/outlet.

It may cause fire or failure due to overheat.



Mandatory

For installation and wiring of the system, observe the installation conditions and methods described in this document.

Otherwise, it may cause a fall, fire, failure, or malfunction.



Mandatory

Install the device in a place where maintenance and inspection can be done easily.

Otherwise, it may cause accidents.

2. Safety precautions on maintenance and inspection

WARNING



Mandatory When installing or removing the module after wiring, make sure that the external power supply is off. Otherwise, there will be live electric poles on the back of the external terminal block of the module, causing an electric shock.

CAUTION

Prohibited Do not drop, crush, or apply strong shocks to the device or board. It may cause failure.

Mandatory Before touching the device or board, touch a grounded metal to discharge the static electricity of your body. Otherwise, it may cause malfunction or failure due to static electricity.

Mandatory Wipe off stain on the device, module, or board with a soft cloth. For severe stain, use a wet cloth wrung tightly. Leaving them stained may cause wrong decision or malfunction.

Mandatory Place a board or module removed from the unit or base unit on a conductive mat or conductive bag (used for a backup board) on a grounded table. Otherwise, parts may be damaged due to static electricity.

Prohibited Do not use benzene or thinner to remove stain on device, module, or board. It may cause deformation or discoloration of the device panel, module, or board.

3. Safety precautions on replacement of life limited parts

WARNING



Required

If the device has power fuses or alarm fuses, when replacing them, turn off the switch of the device. Otherwise, it may cause an electric shock or fire.

4. Safety precautions on daily use

WARNING



No touch

Do not touch the terminals of the module and unit during energization. It may cause an electric shock.



Prohibited

Do not modify, repair, disassemble, or adjust the device, module, or board. It may cause an electric shock, fire, injury, or failure. Upon faulty operation or failure, contact Toshiba's branch office or service offices.



Mandatory

Before using, check that the power capacity, frequency, voltage, and regulation comply with the device specifications. If not, it may cause damage of the device, or fire due to overheat, as well as not obtaining the original performance of the device.



Mandatory

When the ambient or internal temperature of the device rises abnormally or failure occurs in the device, stop using the device, turn off the power, and contact one of Toshiba's service representatives. Using it as is may cause fire due to overheat.



No touch

Do not touch the terminals of the module and unit during energization. It may cause an electric shock. The power supply module is for the nv series only. Do not use it alone for any other purposes.

CAUTION



Do not touch anything other than the operation part (setting switches inside the module), such as the IC parts and terminals, connectors, and soldered surfaces inside the module. Doing so may result in electrostatic breakdown of the ICs and LSIs, causing failure. Also, an injury may occur due to the ends of the part lead wires, or burns may occur due to hot parts.



Do not forcefully bend, pull, or twist the power cord and cables. It may cause breaks or heating.



Do not insert any metal into the gaps of the device main body. It may cause fire.



Do not disassemble or modify the device or module. It may cause malfunction or failure as well as loss of safety of the device.

5. Safety precautions on transportation, storage, and disposal

CAUTION



Observe ordinances and rules. When destroying the product, observe the ordinances and rules of the local government.



For transportation and storage of the product, use a conductive bag and packaging box. Otherwise it will cause failure.

Restrictions on application

- This product is not developed/manufactured for use in systems involving devices that directly affect human life (Note 1). Do not use them for such applications.
- To use this product for systems that involve devices that significantly affect human safety or maintenance of public functions (Note 2), special considerations (Note 3) are required in system operation, maintenance, and management. In this case, contact one of Toshiba's sales representatives.

(Note 1) Devices that directly affect human life include the following.

- Medical devices such as life supporting devices and devices for surgical units.

(Note 2) Systems that involve devices that significantly affect human safety or maintenance of public functions include the following.

- Main unit control systems of nuclear power plants, safety protection systems of nuclear facilities, and other systems that are critical for safety
- Operation control systems of mass transportation systems and air traffic control systems

(Note 3) Special considerations indicate sufficient discussions with Toshiba's engineers to construct a safe system (e.g. employing fool-proof design, fail-safe design, or redundant design).

Disclaimer

- Toshiba shall not be responsible for any damage caused by fire or earthquake, acts of a third party, other accidents, the user's willful acts or negligence, misuse, or use in abnormal conditions.
- Toshiba shall not be responsible for any incidental damage (loss of business profits, interruption of business, change or loss of stored memory) caused by use of or being unable to use this product.
- Toshiba shall not be responsible for any damage caused by failure to observe the information described in the operation manual.
- Toshiba shall not be responsible for any damage caused by malfunctions due to combination with any connected device.
- Toshiba shall not be responsible for any damage caused by malfunctions due to combination with any application program created by the customer.

· Note ·

· Use your cellular phone or PHS 1 meter or more away from the product main unit in operation, ·
· various transmission cables, and I/O bus cable. Otherwise, the system may malfunction. ·

Introduction

This manual describes the functions, methods of installation and setting, and maintenance and inspection of the single bus Ethernet (EN811) module ("EN811 module" hereafter) for connecting the monitoring control network Ethernet to the Unified Controller nv series.

To use this device correctly, read "Safety precautions" first.

The manuals related to the EN811 module are as follows.

- Unified Controller nv series Main Unit Operation Manual (6F8C1220)
Describes the main unit hardware of the nv series controller.
- Unified Controller nv series Type 1 Function Manual (6F8C1221)
Describes the functions and basic use of the nv series Type 1.
- Unified Controller nv series Type 2 Function Manual (6F8C1362)
Describes the functions and basic use of the nv series Type 2.
- Unified Controller nv series/Integrated Controller V Series Command Manual (6F8C1226)
Describes the detailed specifications of the instruction words of the program languages (LD, FBD, and SFC) supported by the nv series and Integrated Controller V Series.
- Unified Controller nv series/Integrated Controller V Series nV-Tool (Basic) Operation Manual (6F8C1290)
Describes how to create, debug, print, and save programs using nV-Tool.
- Unified Controller nv series Ethernet (EN811) Module Manual (6F8C1358) (This document)
Describes the single bus Ethernet module, which is common to Type 1 and Type 2 of the nv series.

● Notational conventions

The following are the notational conventions for better understanding of this document.

- ◆ **Important:** Describes what the user should be particularly aware of to handle the product correctly.
- ◆ **Note:** Describes what the user should observe to handle the product correctly.
- ◇ **Remark:** Describes a remark.

● Reading this document

This document consists of the following chapters.

- Chapter 1 Introducing the EN811 module
Describes the functions, characteristics, and names and functions of the parts.
- Chapter 2 Installation and wiring
Describes how to install it to the basic unit and how to connect cables.
- Chapter 3 Setting
Describes how to set the switches and parameters to use the module correctly.
- Chapter 4 Operation
Describes the operations such as checking before operation, startup, and shutdown.
- Chapter 5 Troubleshooting
Describes troubleshooting such as what to do when failure occurs.
- Chapter 6 Maintenance and inspection
Describes troubleshooting regarding daily inspection and periodical inspection and how to perform inspections.
- Chapter 7 Application interface
Describes the user application interface and usage constraints.

CONTENS

Chapter 1

Introducing the EN811 module

...1

Chapter 2

Installation and wiring

...7

Chapter 3

Setting

...15

Chapter 4

Operation

...41

1.1	Functions and characteristics of the EN811 module	2
1.2	Names and functions of the parts	4
1.2.1	Names of the parts	4
1.2.2	Functions of the parts	5
2.1	Installation (installation to the basic unit)	8
2.2	Connecting the Ethernet cable	10
2.3	Connecting the serial communication port (RS-232C) cable	11
2.4	Replacing the module	12
3.1	Switch setting	16
3.1.1	Station address setting switch (STN-H, STN-L)	16
3.1.2	Operation mode setting switch (MODE)	17
3.2	Network parameter setting	18
3.2.1	Network ID and subnet mask	18
3.2.2	Station address	19
3.2.3	Overview of multicast address	19
3.3	Setting with the engineering tool	21
3.3.1	Network parameter setting	22
3.3.2	Multicast address setting	31
3.3.3	Multicast routing network setting	33
3.3.4	Ethernet link speed/duplex setting	34
3.3.5	Default gateway IP address (router IP address) setting	35
3.3.6	Option function	37
3.4	Network information	38
3.4.1	LAN control information	38
3.4.2	MIB information	39

Chapter 5

Troubleshooting

...43

Chapter 6

Maintenance and inspection

...45

Chapter 7

Application interface

...49

Appendix A

Specifications

...61

Appendix B

Outside dimensions

...65

6.1	Inspection	46
6.1.1	Daily inspection	46
6.1.2	Periodical inspection	47
6.2	Life limited parts	47
7.1	Information by socket	51
7.1.1	Configuration of information by single Ethernet socket	51
7.1.2	Referring to information by socket.....	52
7.1.3	Timing of generation of information by socket.....	53
7.2	Transmission path diagnosis information	55
7.2.1	Configuration of transmission path diagnosis information.....	55
7.2.2	Referring to transmission path diagnosis information	56
7.2.3	Configuration of a transmission path diagnosis frame	57
7.3	EN811 module state information	58
7.4	Usage constraints	59
7.4.1	Port number constraints.....	59
7.4.2	Frame size constraints.....	59
A.1	General specifications	62
A.2	Ethernet transmission specifications	63
A.3	Function specifications	63
A.4	Serial communication port (RS-232C) transmission specifications	64

Appendix C

Related products

...67

Appendix D

**Decimal-hexadecima
l conversion table**

...69

Appendix E

**Sample
programs**

...73

Appendix F

Return code list

...85

Chapter 1

Introducing the EN811 module

This chapter describes the functions, characteristics, and names and functions of the parts.

1.1	Functions and characteristics of the EN811 module	2
1.2	Names and functions of the parts	4
1.2.1	Names of the parts	4
1.2.2	Functions of the parts	5

1.1 Functions and characteristics of the EN811 module

The EN811 module is a device to connect the controller main unit of the Unified Controller nv series to the monitoring control network Ethernet.

The EN811 module is for single bus. Up to 4 units can be installed to the basic unit. Twisted pair cables are used for connection.

■ Characteristics of the EN811 module

- High bandwidth

The EN811 module supports transmission speeds of up to 1Gbps, allowing the user to construct a high-bandwidth network.

- Openness

The EN811 module can support transmission speeds of 10M, 100M, and 1Gbps to achieve the openness of Ethernet at the network level.

- Supporting multiple Ethernet modules

The EN811 module can perform transmission request processing for multiple Ethernet modules from the host side.

- Communication service

Message transmission supports Toshiba's standard protocol PCMP as well as TCP, UDP, and IP. It also supports multicast transmission to implement the group broadcast function.

◇ Remark

-
- PCMP: Process Control Message Protocol

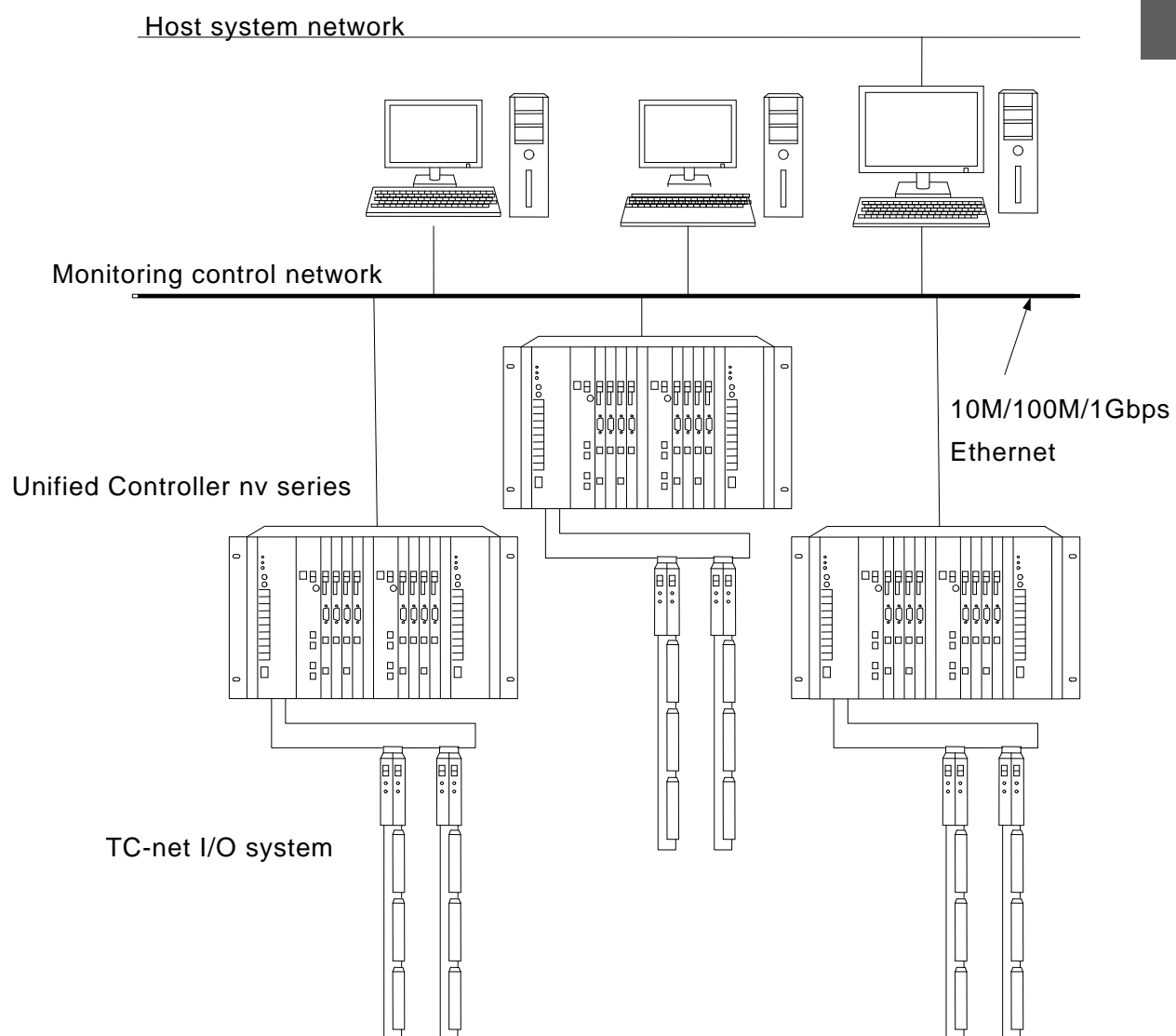
Example of system configuration**Figure 1-1 System configuration example**

1.2 Names and functions of the parts

1.2.1 Names of the parts

Figure 1-2 shows the names of the parts of the EN811 module.

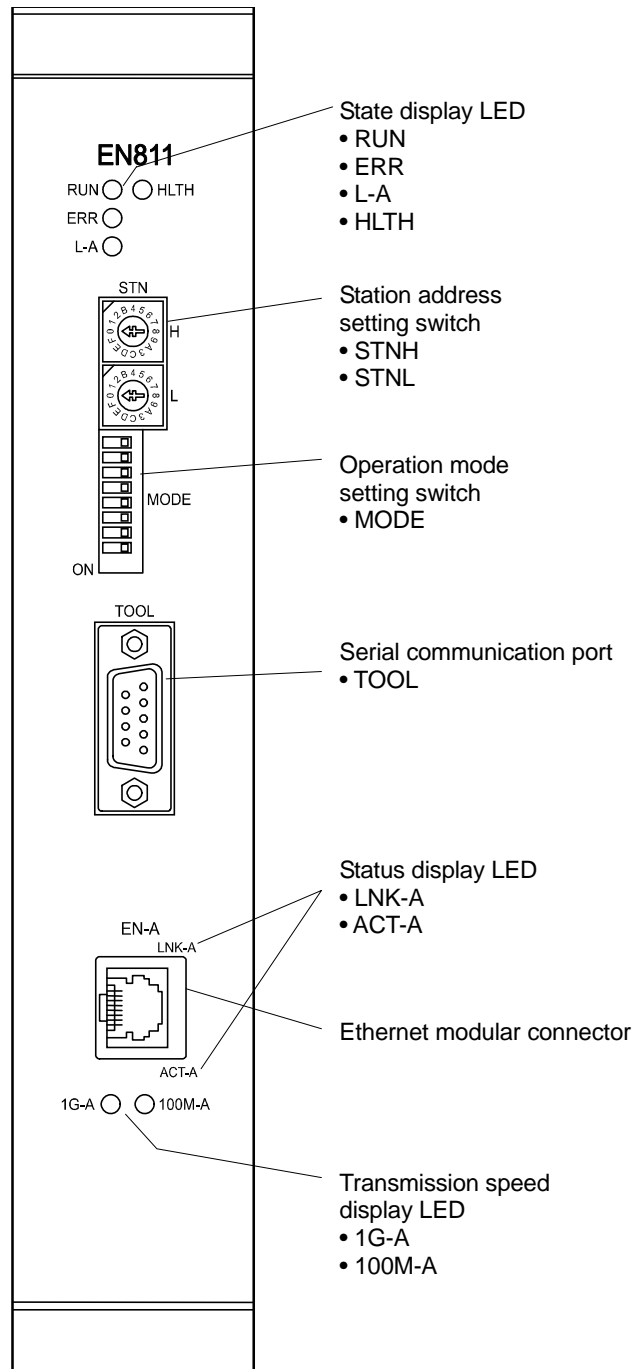

Figure 1-2 Names of the parts of the EN811 module

1.2.2 Functions of the parts

The major functions of the parts are as shown below.

■ State display LED

Table 1-1 Display on the state display LED and normal display

Name	Display	Normal display
RUN (green)	Displays the hardware operation state. ON: Running OFF: Down	ON
ERR (red)	Displays the hardware operation state. ON: Down OFF: Running	OFF
HLTH (green)	Displays the EN module state. ON: Network parameter is normal OFF: Network parameter is abnormal	ON
L-A (green)	Displays Ethernet A system state. ON/Blinking: Ethernet transmission is in execution OFF: Ethernet transmission is under suspension	ON/Blinking
LNK-A (green)	Displays Ethernet A system link state. ON: Link has been established normally OFF: No link has been established	ON
ACT-A (green)	Displays Ethernet A system state. Blinking: Ethernet transmission is in execution OFF: Ethernet transmission is under suspension	Blinking
1G-A (green)	Link has been established at 1Gbps	—
100M-A (green)	Link has been established at 100Mbps	—

(Note)1. If 1G-A and 100M-A are OFF, a link has been established at 10Mbps.

2. Check the LED states from the front.
3. Refer to "Table 5-1 Diagnosis using the LEDs."

■ Station address setting switch (STN-H, STN-L)

Switches to set the station address in hexadecimal. For setting method, refer to "Chapter 3 Setting."

■ Operation mode setting switch (MODE)

Switches to set the operation mode. For setting method, refer to "Chapter 3 Setting."

■ **Serial communication port RS-232C (TOOL)**

A RS-232C port for maintenance. The connector is a 9-pin D-sub connector (socket).

■ **Ethernet RJ-45 connector (EN-A)**

A communication port for Ethernet. An Ethernet cable (Category 6/Category 5e) is connected.



Chapter 2



Installation and wiring



This chapter describes installation and wiring methods of the EN811 module. Before installation and wiring, read this operation manual thoroughly.



2.1	Installation (installation to the basic unit)	8
2.2	Connecting the Ethernet cable	10
2.3	Connecting the serial communication port (RS-232C) cable	11
2.4	Replacing the module	12



2.1 Installation (installation to the basic unit)



2



	WARNING	Before installing or removing the module, make sure that the basic unit to which the EN8 module is installed is turned off. Otherwise, it may cause an electric shock.	 Mandatory
---	----------------	---	---



	WARNING	Do not touch the interior of the product except the switches. It may cause an electric shock.	 Prohibited
---	----------------	--	--



	CAUTION	Install it under an environment that satisfies the product specifications. When installing it under an environment that does not satisfy the product operating temperature range, apply forced cooling with cooling equipment. Operating temperature range: 0 to 55°C	 Prohibited
---	----------------	---	--

	CAUTION	Before installation or wiring, remove the static electricity from your body. The static electricity accumulated in the human body may cause failure of the product.	 Prohibited
---	----------------	--	--

	CAUTION	When installing the product to the basic unit, do not bend the pins of the station bus connector.	 Prohibited
---	----------------	---	--

	CAUTION	If it is difficult to insert the module to the basic unit, remove it once and try again rather than forcing it.	 Prohibited
---	----------------	---	--

	CAUTION	When installing two or more Ethernet modules to the same basic unit, make sure that the system and segment of the transmission path are correct.	 Prohibited
---	----------------	--	--

	CAUTION	Use a Phillips screwdriver. To prevent damage to the screws, use a screwdriver that is suitable for the screws.	 Prohibited
---	----------------	--	--

Install the module to the basic unit in the following steps.

1 As shown in Figure 2-1, insert the module while aligning the module bottom along the module guide of the basic unit.

The EN811 module can be installed to the following slot numbers.

8-slot basic unit: Slot numbers 2 to 7

2 Secure the module.

After installing it to the basic unit, secure it using the screws at the top and bottom of the module.

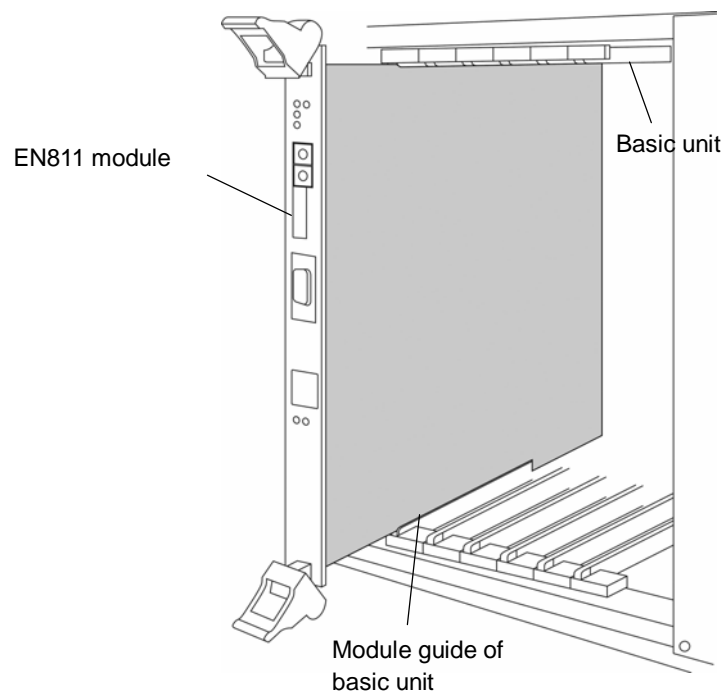







Figure 2-1 Installing to the basic unit

2.2 Connecting the Ethernet cable

Connect the Ethernet cable (Category 6/Category 5e twisted pair cable: 1000BASE-T) to the EN811 module.

 CAUTION	<p>Before installation or wiring, remove the static electricity from your body.</p> <p>The static electricity accumulated in the human body may cause failure of the product.</p>	 Mandatory
--	---	---

 CAUTION	<p>Do not touch the cables carelessly.</p> <p>Applying stress to the cables may cause malfunction or accidents.</p>	 Prohibited
--	---	--

 CAUTION	<p>Perform a notification check in the application level using the transmission protocol.</p> <p>When an error occurs such as unable to turn on the power, stop using and contact one of Toshiba's service representatives.</p> <p>If you have any question, consult with one of Toshiba's service representatives.</p>	 Mandatory
--	---	---

■ 1000BASE-T/100BASE-TX/10BASE-T

Connect the cable in the following steps.

1 Connect the Category 6/Category 5e twisted pair cable to the Ethernet connector (EN-A).

Be aware of the direction of the connector hook.

2 After inserting the connector, make sure that the cable is locked.

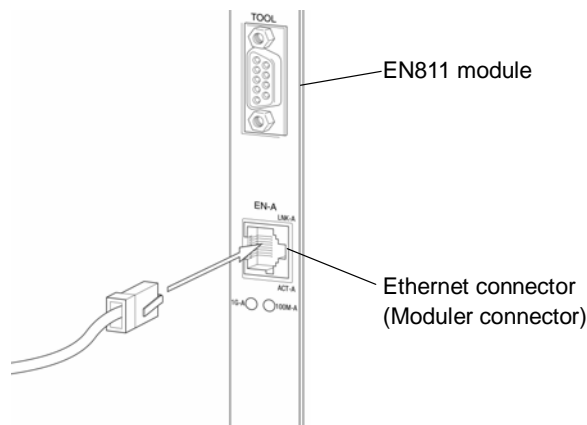

Figure 2-2 Connecting the Category 6/Category 5e twisted pair cable

2.3 Connecting the serial communication port (RS-232C) cable

For downloading programs or performing maintenance, the serial communication port (TOOL) can be used to communicate with the tool. RS-232C is used for communication.

The RS-232C cable connector is a 9-pin D-sub connector (socket).

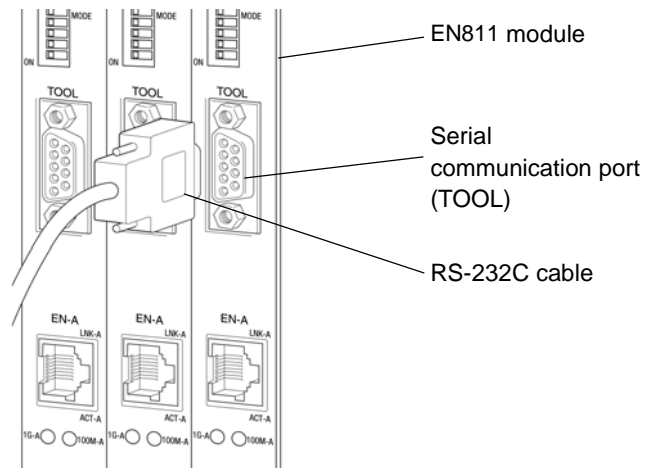

Figure 2-3 Connecting the serial communication port

2.4 Replacing the module

2



CAUTION

Turn off the basic unit.

When replacing the module, turn off the basic unit and make sure that the power is off. Otherwise, failure of the module or electric shock may occur.



Mandatory

When changing the switch settings or in case of failure, replace the module in the following steps.

- 1 Turn off the basic unit.**
Make sure that it is off by using LED display.
- 2 Hold the hook of the modular connector of the module, and remove the Category 6/Category 5e twisted pair cable.**
- 3 Loosen the M4 screws at the top and bottom of the module with a Phillips screwdriver, and remove it along the module guide of the basic unit.**
- 4 Set the switch settings of the new module to the settings of the removed module.**
- 5 Install the new module to the basic unit.**
- 6 When using it in the [Set from the tool (arbitrary setting)] mode or setting multicast addresses, download the network parameters.**
For download, connect the engineering tool to the serial communication port (TOOL) of the EN811 module. Until the download is complete, no download can be done via the Ethernet.
- 7 When the download is complete, turn off the basic unit with the EN811 module again.**
- 8 Make sure that the basic unit is turned off before wiring the cables.**

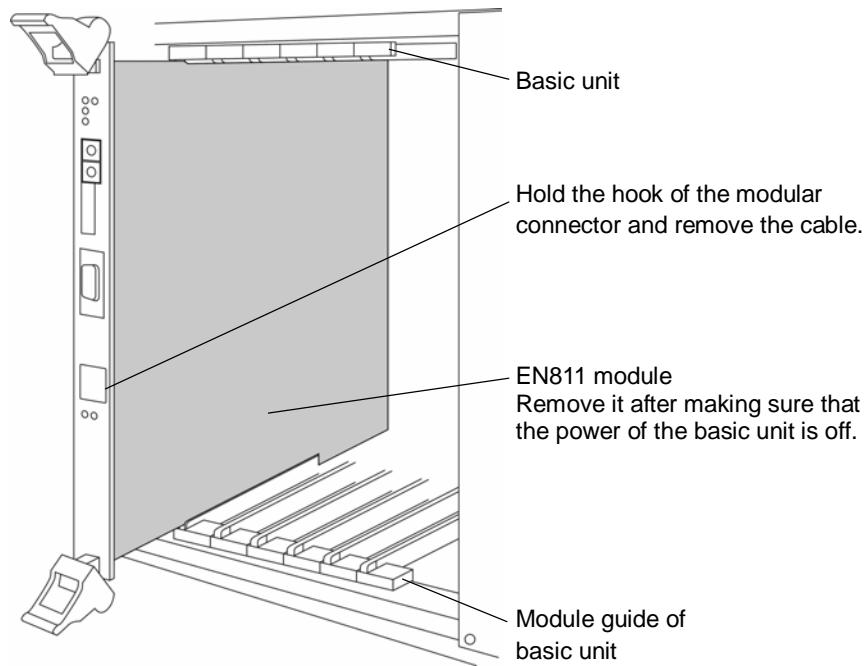

Figure 2-4 Replacing the EN811 module

2

Chapter 3

Setting

3.1	Switch setting	16
3.1.1	Station address setting switch (STN-H, STN-L)	16
3.1.2	Operation mode setting switch (MODE) .	17
3.2	Network parameter setting	18
3.2.1	Network ID and subnet mask	18
3.2.2	Station address	19
3.2.3	Overview of multicast address	19
3.3	Setting with the engineering tool	21
3.3.1	Network parameter setting	22
3.3.2	Multicast address setting	31
3.3.3	Multicast routing network setting	33
3.3.4	Ethernet link speed/duplex setting	34
3.3.5	Default gateway IP address (router IP address) setting	35
3.3.6	Option function	37
3.4	Network information	38
3.4.1	LAN control information	38
3.4.2	MIB information	39

3.1 Switch setting

The switches that determine the operation mode and station address are on the front panel of the EN811 module.

The method to set the switches is shown below.

◆ Important

- Set the switches that determine the operation mode and station address of the EN811 module before turning the power on.

3.1.1 Station address setting switch (STN-H, STN-L)

The station address setting switches are hexadecimal rotary switches that determine the station address on the Ethernet network.

For setting of the IP address, refer to "3.2 Network parameter setting." Set the station address (1 to 254) that has been assigned upon system configuration in a HEX code. Assign an address with a different value to each of the nodes in the system.

Table 3-1 shows the setting of a station address.

Table 3-1 Station address setting

Name	Description
	Setting range : 01 to FE(h)
STN-H	STN-H(upper address): 0 to F(h)
STN-L	STN-L(lower address): 0 to F(h)

(Note) (h) indicates hexadecimal.

◇ Remark

- For setting, use a small slotted screwdriver.

Set the station address in hexadecimal.

For example, if the address value is 28, it is '1C'(h) when converted to hexadecimal. Therefore, set as follows:

STN-H side: '1'

STN-L side: 'C'

For decimal-hexadecimal conversion, refer to "Appendix D Decimal-hexadecimal conversion table."

◆ Note

- Be careful so that the address does not overlap with other nodes.

3.1.2 Operation mode setting switch (MODE)

The operation mode setting switches are 8-bit dip switches that determine the operation of the EN811 module.

When the switch lever of each bit of the dip switch is turned to left (to the ON side), it is set to ON; when it is turned to right, it is set to OFF.

Table 3-2 shows the descriptions of the switches.

◇ **Remark**

- For setting, use a small slotted screwdriver.

Table 3-2 Operation mode setting table

Switch number	Name	Function	Setting	Initial setting (factory setting)				
1	SM0	Operation mode	SM0	off	on	off	SM0: off SM1: off SM2: off (normal setting)	
2	SM1		SM1	off	off	on		
3	SM2		SM2	off	off	off		
			Operation	Normal	For maintenance			
4	RV1	Reserved	Not used				off	
5	RV2	Reserved	Not used				off	
6	IPF	Sets IP address to free	on: Free, off: Restricted				off	
7	IP0	IP address type	IP0	off	on	off	on	IP0: off IP1: off (Class B setting)
8	IP1		IP1	off	off	on	on	
			Operation	Class B 172.16.64. xx	Reserved	Class C 192.168.0.xx	Tool setting	

■ Operation mode

Normally use the normal setting state.

◆ **Important**

- Never use the maintenance mode.

■ IP address type

IP address types include Class B(factory setting), Class C, and tool setting.

Tool setting is used to use network parameters set by the engineering tool.

3.2 Network parameter setting

The network parameters can be set with the operation mode setting switches and station address setting switches.

For methods to set these switches, refer to "Table 3-1 Station address setting" and "Table 3-2 Operation mode setting table."

For the EN811 module, the following network parameters must be set.

- IP address type
- Station address

3.2.1 Network ID and subnet mask

■ Class B setting (IPF=off, IP0=off, IP1=off)

Use the operation mode setting switches to set the IP address type to "Class B." This is the standard setting of the unified controller system.

Network ID: 172.16.64.XX

(XX indicates the value of the station address setting switches)

Subnet mask : 255.255.192.0

■ Class C setting (IPF=off, IP0=off, IP1=on)

Use the operation mode setting switches to set the IP address type to "Class C."

Network ID: 192.168.0.XX

(XX indicates the value of the station address setting switches)

Subnet mask : 255.255.255.0

■ Arbitrary setting (IPF=on, IP0=on, IP1=on)

Use the operation mode setting switches to set the IP address type to [Tool setting], and set IPF to [ON].

When this setting is selected, it can be set freely from the engineering tool, and the value has precedence over the value of the station address setting switches.

However, the following cannot be used in the IP address.

- Addresses starting with 127(7Fh)
- Addresses with all bits of the network address are "0" or "1"
- Addresses with all bits of the host address are "0" or "1"

The value of the subnet mask consists of a series of "1" from the most significant bit.

3.2.2 Station address

Use the station address setting switches to set the station address.

Any station address can be set; however, it must be unique within the system. The available setting range for station addresses is from 01(h) to FE(h)(1 to 254).

When the IP address type is [Tool setting], it has precedence over the value of the station address setting switches. In this case, it is recommended matching the lowermost value of the specified IP address (5 in the case of 172.16.64.5) and the value of the station address setting switches. For [Tool setting], set the station address in the dotted decimal notation using the engineering tool.

3

3.2.3 Overview of multicast address

The EN811 module supports 15 multicast addresses.

Among all multicast addresses (224.0.0.0 to 239.255.255.255), any 15 addresses can be selected and registered.

◇ Remark

- 224.0.0.0 to 224.0.0.255 are restricted to use in the local network, so multicast packets whose destination is one of the multicast addresses in this range cannot be transferred by the router.

In addition, some of the multicast addresses are reserved. Check the address before use.

Registration to the EN811 module is performed with the engineering tool.

For the registration method, refer to "3.3 Setting with the engineering tool."

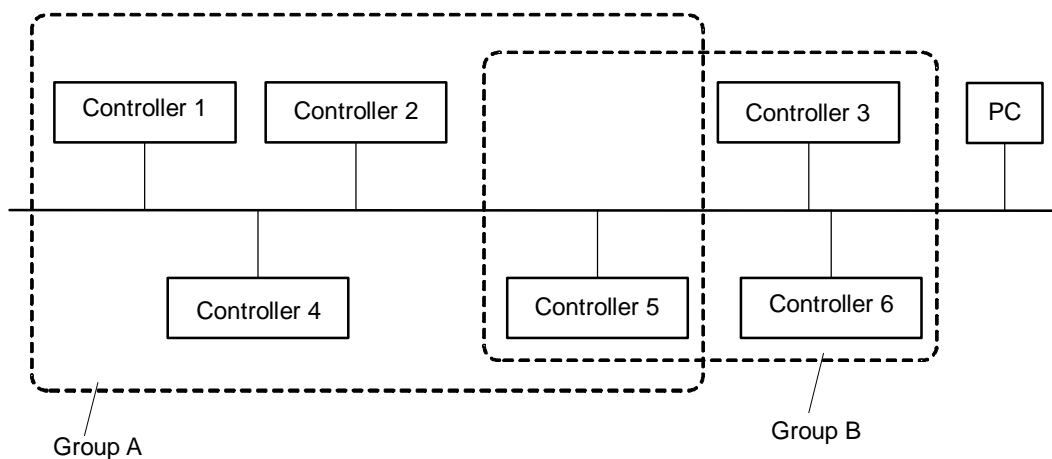

Figure 3-1 An example of multicast group configuration

In multicast, controllers can be grouped as shown in the example of Figure 3-1.

Controllers 1, 2, 4, and 5 belong to Group A, and Controllers 3, 5, and 6 belong to Group B.

In this example, multicast addresses are set as follows:

- Multicast addresses in Group A239.128.0.1
- Multicast addresses in Group B239.128.0.2

By doing this, the controllers can be grouped by registering them as follows:

- Controllers 1, 2, 4.....239.128.0.1
- Controllers 3, 6.....239.128.0.2
- Controllers 5.....239.128.0.1 and 239.128.0.2

The setting above allows messages to be passed to the controllers that belong to the group simultaneously.

3.3 Setting with the engineering tool

Settings to the EN811 module can be done with the engineering tool.

For the operation method of the engineering tool, refer to "Unified Controller nv series/Integrated Controller V series nV-Tool(Basic) operation manual "(6F8C1290).

Connect the engineering tool and nv series controller via Ethernet. In the nv controller side, connect the RS-232C cable to the serial communication port (TOOL) on the front of the EN811 module (system configuration in Figure 3-2).

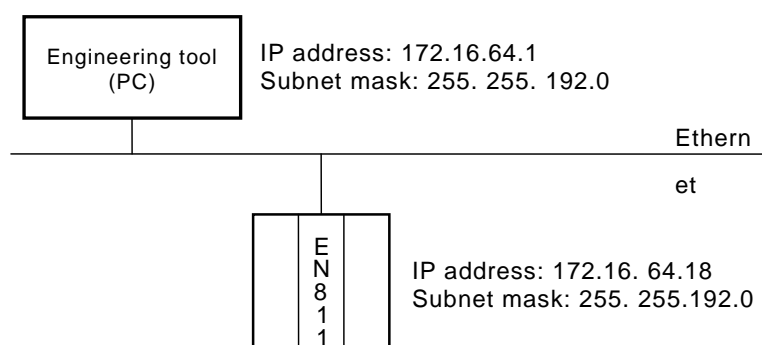

Figure 3-2 System configuration of the example

Set the IP address shown in Figure 3-2 to the EN811 module. Using the rotary switch of the EN811 module, set the lowermost digit of the IP address in hexadecimal (in this case, convert "18" into hexadecimal and set "12(h)," i.e. H=1, L=2).

Set all the operation mode setting switches of the EN811 module to OFF.

For decimal-hexadecimal conversion, refer to "Appendix D Decimal-hexadecimal conversion table."

◆ **Note**

- The switch setting becomes effective from the next startup. Restart the controller after setting.

3.3.1 Network parameter setting

Set the network parameters of the EN811 in the following steps.

1 Select the EN811 module from the product tree.

Select [Station] under the created system, and select [New (W)] from [File (F)] on the menu bar.

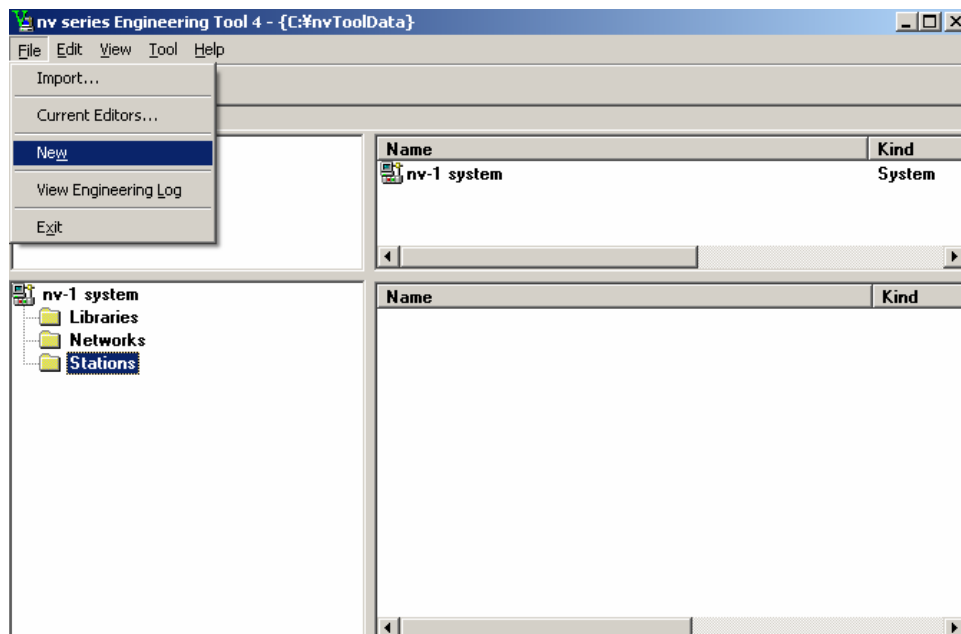

Figure 3-3 Station registration screen

2 Set the station name.

Select "nv station" from Station model name, and set the station name ("Stn1" is set in this example).



Figure 3-4 Station name setting screen

3 Add the unit to the station.

Select [Unit] under the created station, and select [New (W)] from [File (F)] on the menu bar.

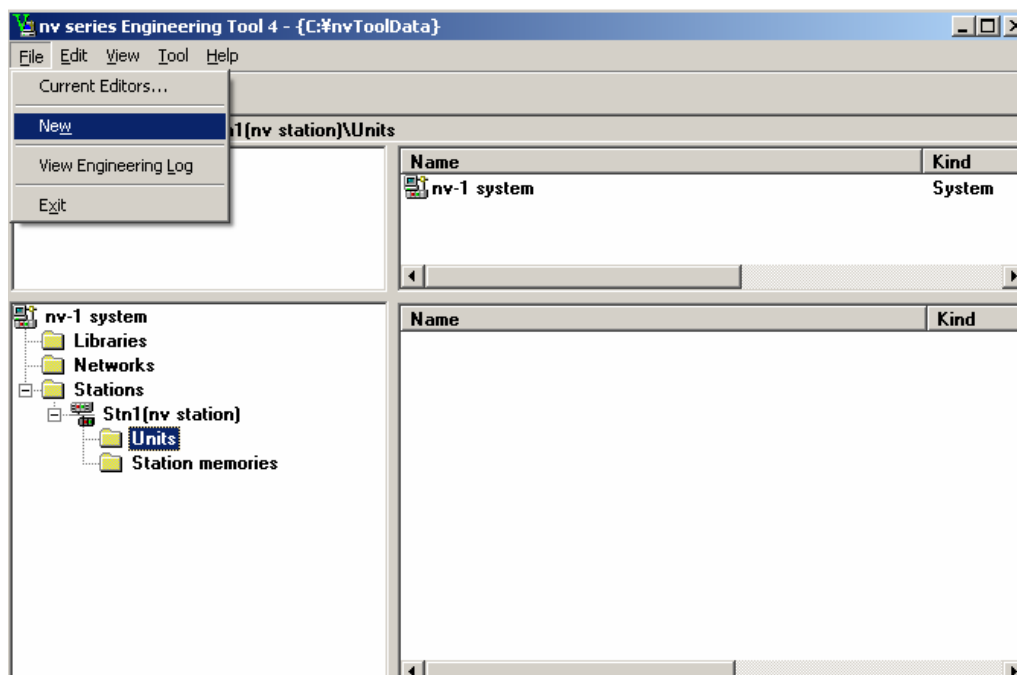

Figure 3-5 Unit registration screen

4 Add the module to the unit.

Select [Module] under the unit, and select [New (W)]. Select "EN811 module" from the module addition dialog.

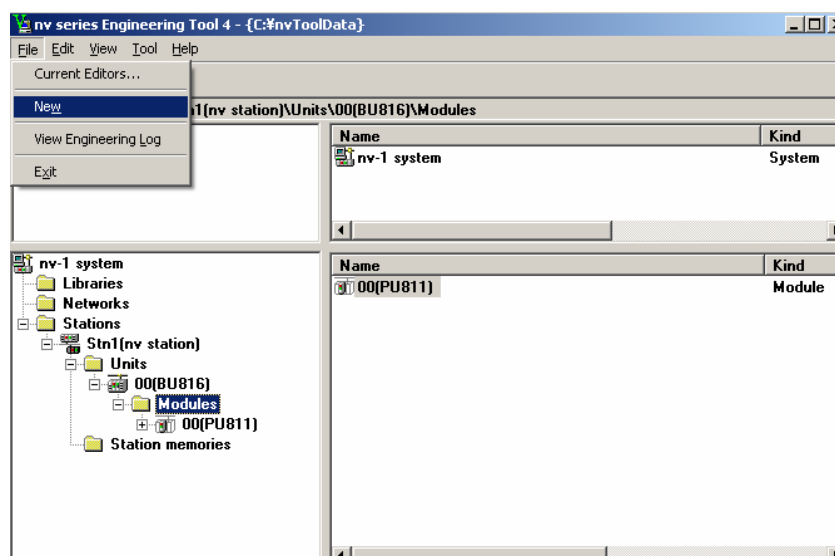

Figure 3-6 Module registration screen

5 Select the added EN811 module.

When [Module parameter] is selected from [File (F)] on the menu bar, the module parameter screen is displayed.

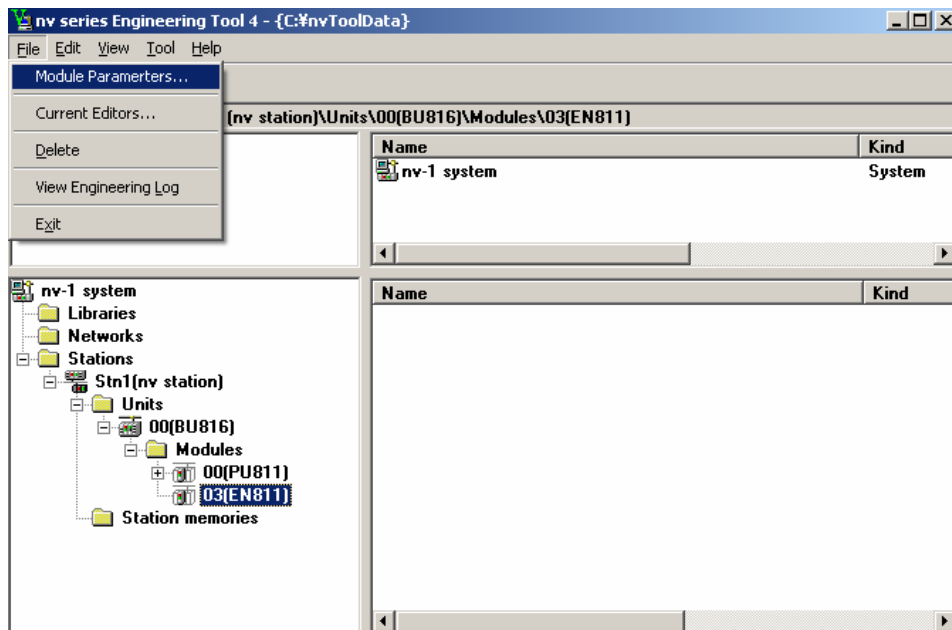

Figure 3-7 An example of module registration

6 When the registration above is complete, check that the network information of the corresponding EN811 module can be read from the serial communication port (TOOL).

From the product tree, open the module parameter screen for the EN811 module previously registered.

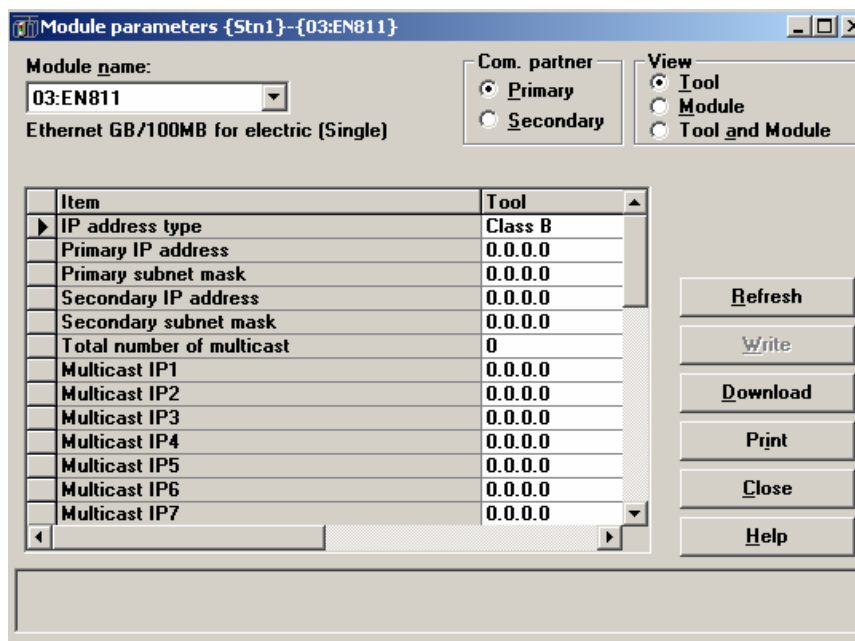

Figure 3-8 Module parameter registration screen

7 Register the IP address type, IP address, and subnet mask.

◆ **Note**

- Be careful so that the address does not overlap with other nodes.

Individual settings are as follows.

For the IP address type, select from Class B, Class C, and Arbitrary.

Class B sets all of the bits No.6 to 8 of the operation mode setting switches (MODE) of the EN811 module to OFF.

IP address : 172.16.64.xx (xx indicates the value of the station address setting switches)

Subnet mask : 255.255.192.0

Class C sets the bits No.6 to OFF, No.7 to OFF, and No.8 to ON of the operation mode setting switches (MODE) of the EN811 module to OFF.

IP address : 192.168.0.xx (xx indicates the value of the station address setting switches)

Subnet mask : 255.255.255.0

Arbitrary setting sets the bits No.6 to ON, No.7 to ON, and No.8 to ON of the operation mode setting switches (MODE) of the EN811 module to OFF. In this case, the value set from the tool has precedence over the value of the station address setting switches.

◆ **Note**

- When arbitrary setting is used, the EN811 module does not start up until no arbitrary setting is done from engineering tool. When performing arbitrary setting for the first time, set the operation mode setting switches to the Class B setting and start the EN811 module. After the startup, change the setting to arbitrary setting, and then register the IP address.

For registration of multicast, refer to "3.3.2 Multicast address setting." For the option switches, refer to "3.3.6 Option functions."

8 Download the registered information to the EN811 module.

To download, display the parameter information, and click [Download (D)].

Module parameters {Stn1}-{03:EN811}

Module name: 03:EN811
Ethernet GB/100MB for electric (Single)

Com. partner: Primary Secondary

View: Tool Module Tool and Module

Item	Tool
IP address type	Class B
Primary IP address	172.16.64.18
Primary subnet mask	255.255.192.0
Secondary IP address	0.0.0.0
Secondary subnet mask	0.0.0.0
Total number of multicast	0
Multicast IP1	0.0.0.0
Multicast IP2	0.0.0.0
Multicast IP3	0.0.0.0
Multicast IP4	0.0.0.0
Multicast IP5	0.0.0.0
Multicast IP6	0.0.0.0
Multicast IP7	0.0.0.0
Multicast IP8	0.0.0.0

Input range: 0 < String length < 20

Buttons: Refresh, Write, Download, Print, Close, Help

Figure 3-9 An example of module parameter registration

◆ Note

- If the controller is in a redundant configuration, the module parameters of the EN811 can be downloaded independently by selecting [Primary (P)] and [Secondary (S)] from [Transmission target].

9 Restart it.

The downloaded information becomes effective at the next startup.

After the download is complete, restart it.

10 From the product tree, set the network.

Select the network under the system, and select [New (W)].

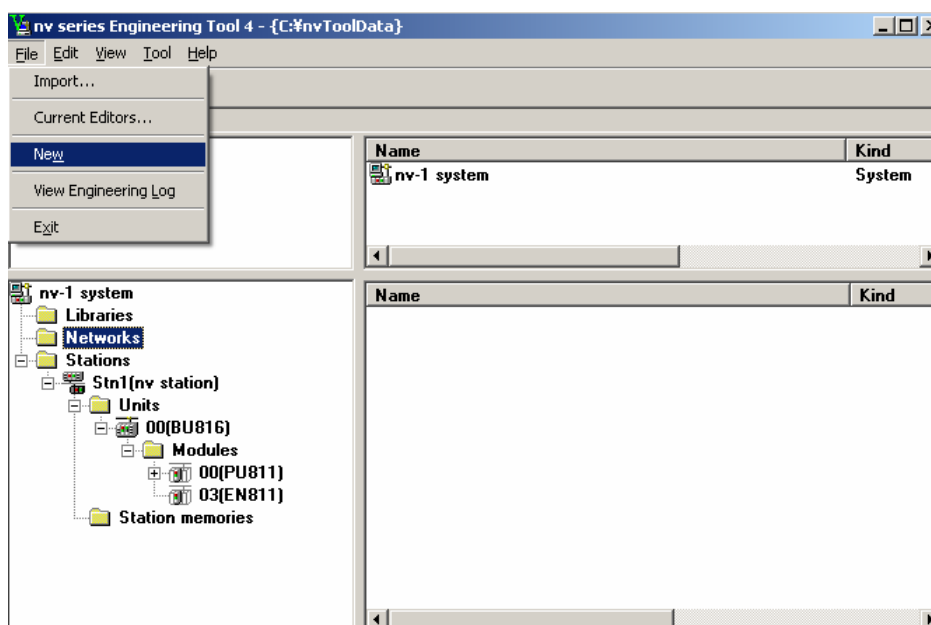

Figure 3-10 Network registration screen

11 Select [EtherLAN] from the network addition dialog.

Select the module under the selected [EtherLAN], and then select [New (W)].

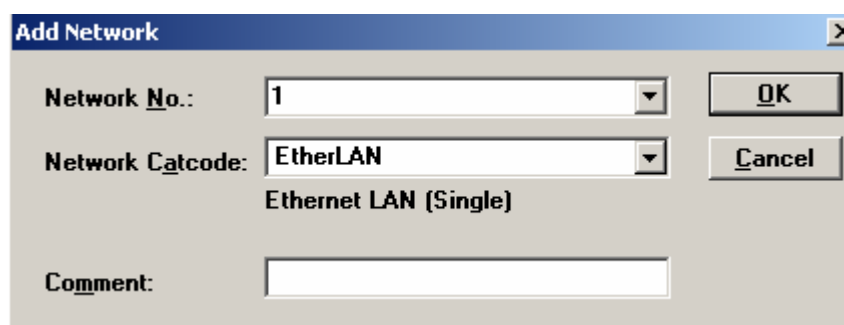

Figure 3-11 Network addition dialog

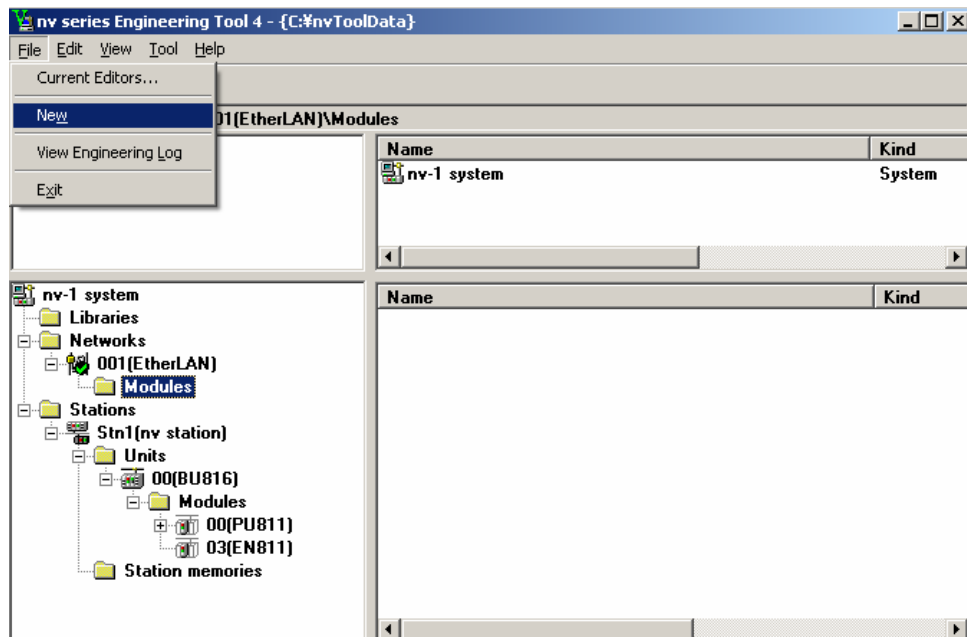

Figure 3-12 Network module registration screen

12 Connect to [EtherLAN].

The EN811 module added previously is displayed on the module addition dialog. Selecting it connects it to EtherLAN.

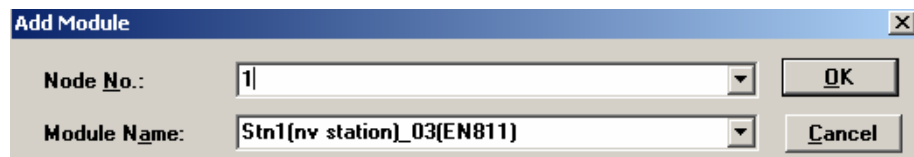

Figure 3-13 Network module addition dialog

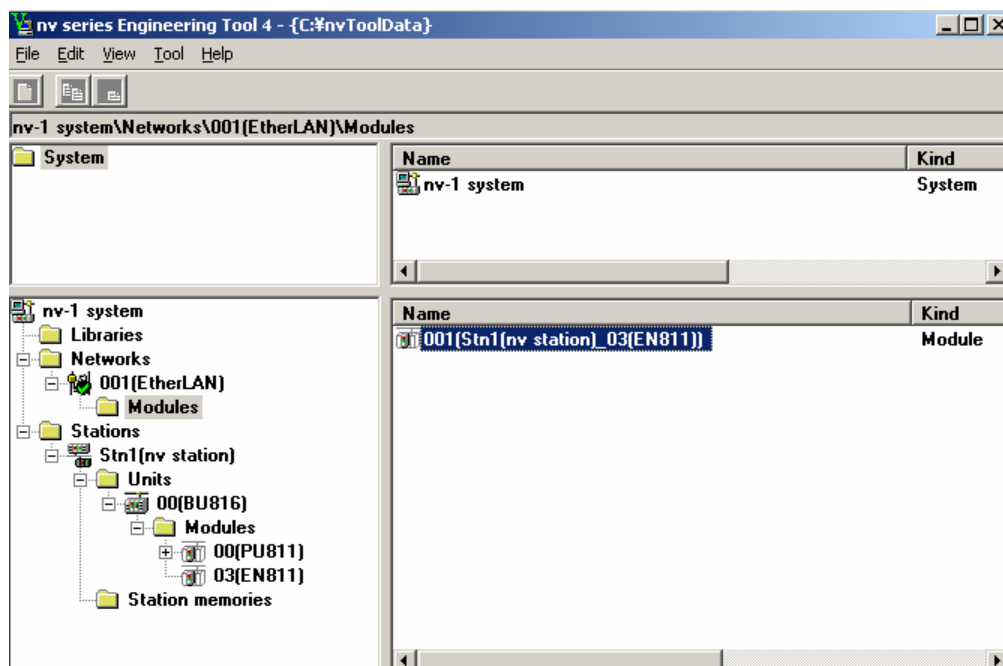

Figure 3-14 Ether LAN connection screen

13 Connect the engineering tool to the serial communication port (TOOL) of the EN811 module to obtain the information of the current EN811 module.

Select [Transmission parameter (P)] from [Tool (T)] on the menu bar to set the transmission parameters.

Register the following and click [OK]. Refer to "Table 3-15 Transmission parameter setting screen"

Transmission method : RS-232C

Port : COM1 (specify the port to use. COM1 in this example)

Timeout time (s): 5

Ethernet timeout time (s): 4,

Own station setting: Single

IP Address: 172.16.64.1

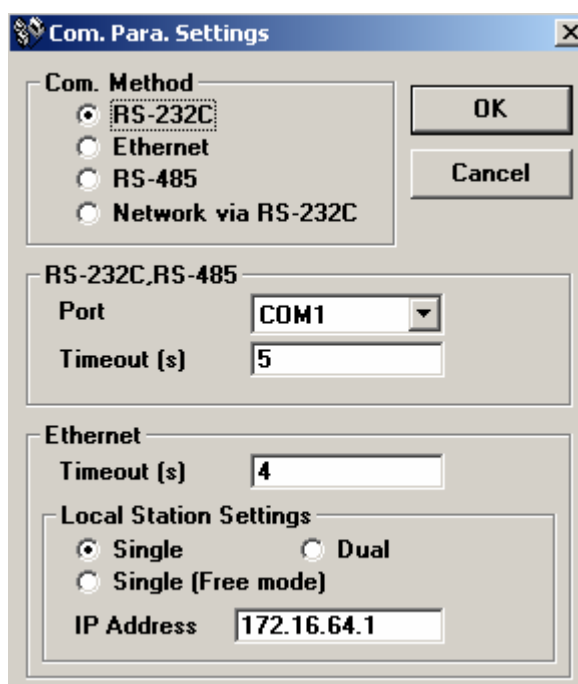

Figure 3-15 Transmission parameter setting screen

- 14 After the registration is complete, check that the information of the EN811 module can be read.

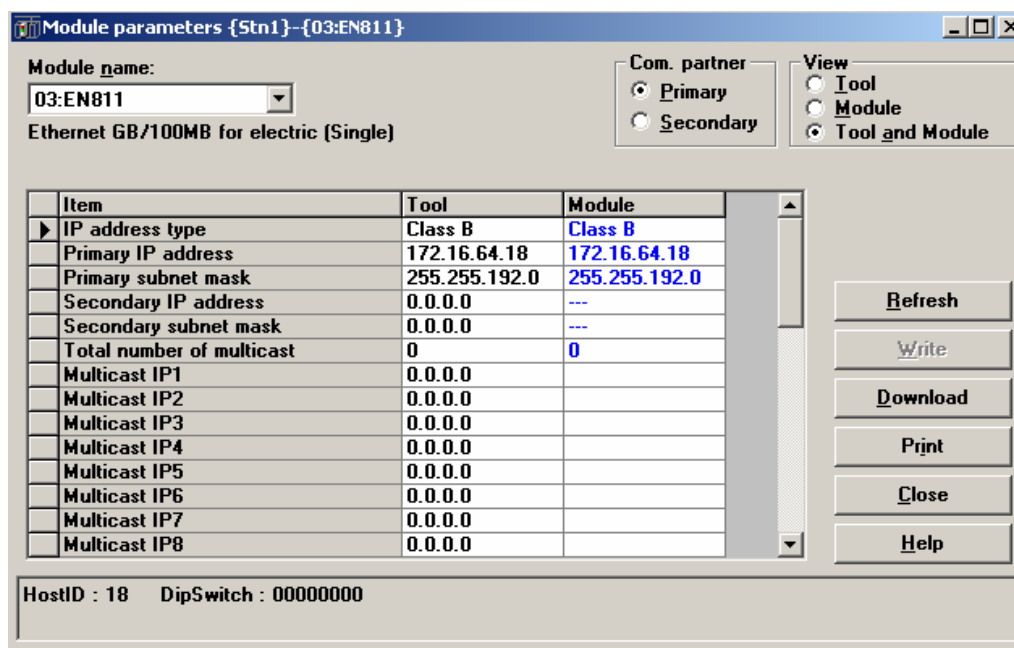

Figure 3-16 An example of reading EN811 module information

3.3.2 Multicast address setting

Set the multicast address in the following steps.

1 Set the number of multicast addresses to register to the multicast registration count.

The setting range is from 0 to 15. "0" indicates not used (1 in this example).

2 Register the multicast IP address.

Available addresses are from 224.0.0.0 to 239.255.255.255 (239.128.0.1 in this example).

◇ Remark

- To register multicast addresses, align them to the top.

Item	Tool	Module
IP address type	Class B	Class B
Primary IP address	172.16.64.18	172.16.64.18
Primary subnet mask	255.255.192.0	255.255.192.0
Secondary IP address	0.0.0.0	---
Secondary subnet mask	0.0.0.0	---
Total number of multicast	1	0
Multicast IP1	239.128.0.1	
Multicast IP2	0.0.0.0	
Multicast IP3	0.0.0.0	
Multicast IP4	0.0.0.0	
Multicast IP5	0.0.0.0	
Multicast IP6	0.0.0.0	
Multicast IP7	0.0.0.0	
Multicast IP8	0.0.0.0	

Figure 3-17 An example of multicast address setting

3 When the registration is complete, click [Download (D)].

- 4 After the download is complete, check that they are set successfully.

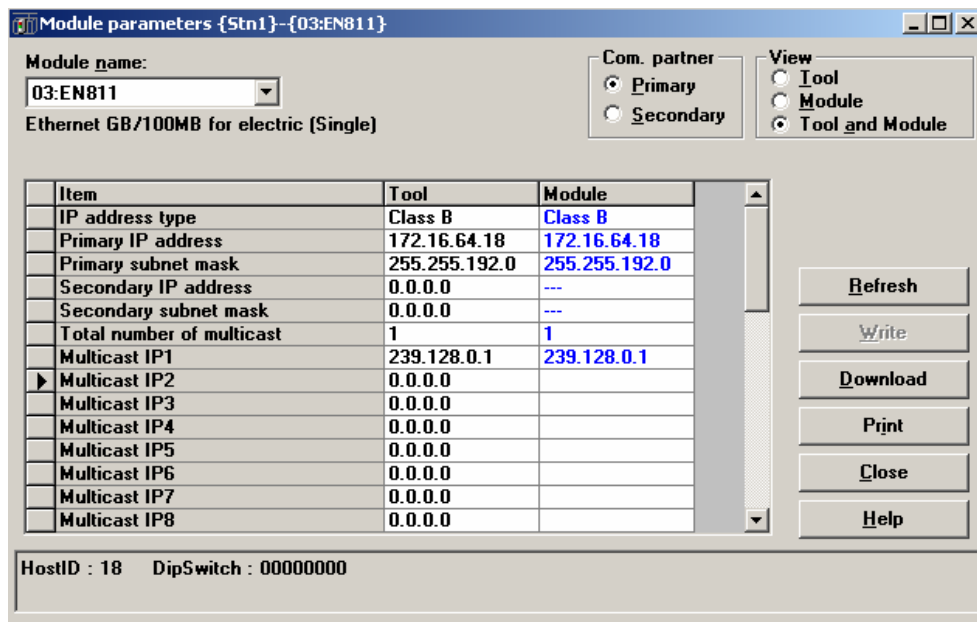

Figure 3-18 An example of reading EN811 module information

◆ Note

- If the controller is in a redundant configuration, the module parameters of the EN811 can be downloaded independently by selecting [Primary (P)] and [Secondary (S)] from [Transmission target].

- 5 Restart it.

The downloaded network parameters become effective at the next startup.

After the download is complete, restart it.

3.3.3 Multicast routing network setting

When connecting the EN811 module to the multicast routing network using multicast routers, set the following items.

- IP address arbitrary setting
- Option switch 1 setting
- Multicast TTL setting

This section describes [Option switch 1 setting] and [Multicast TTL setting]. For [IP address arbitrary setting], refer to "3.2.1 Network ID and subnet mask."

3

■ Option switch 1 setting (IGMP setting)

[Option switch 1 setting] sets IGMP processing. Open the module parameter screen from the network parameter setting screen of the engineering tool, and set [Option switch 1] to [ON].

◇ Remark

- GMP: Internet Group Management Protocol
Used when multicast packets are transmitted via routers.

■ Multicast TTL setting

Open the module parameter screen from the network parameter setting screen of the engineering tool, and set the value of [Multicast TTL]. The available range is from 1 to 64 (the default value is 1).

The value of multicast TTL must be at least the number of multicast routers that exist in the route from the EN811 module to the destination node plus 1. In the network configuration below, it is 3.

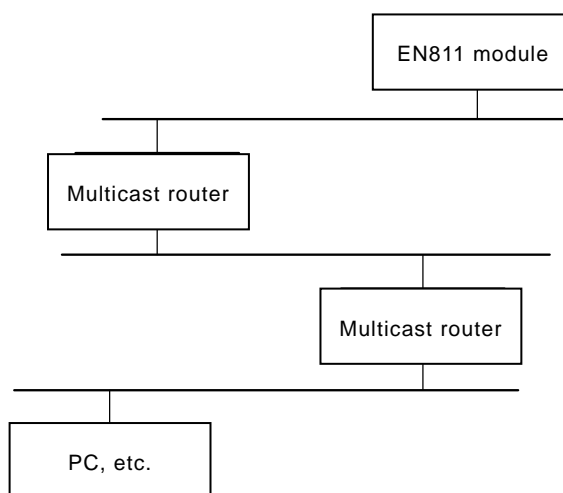

Figure 3-19 An example of multicast routing network configuration

The setting example above is shown below.

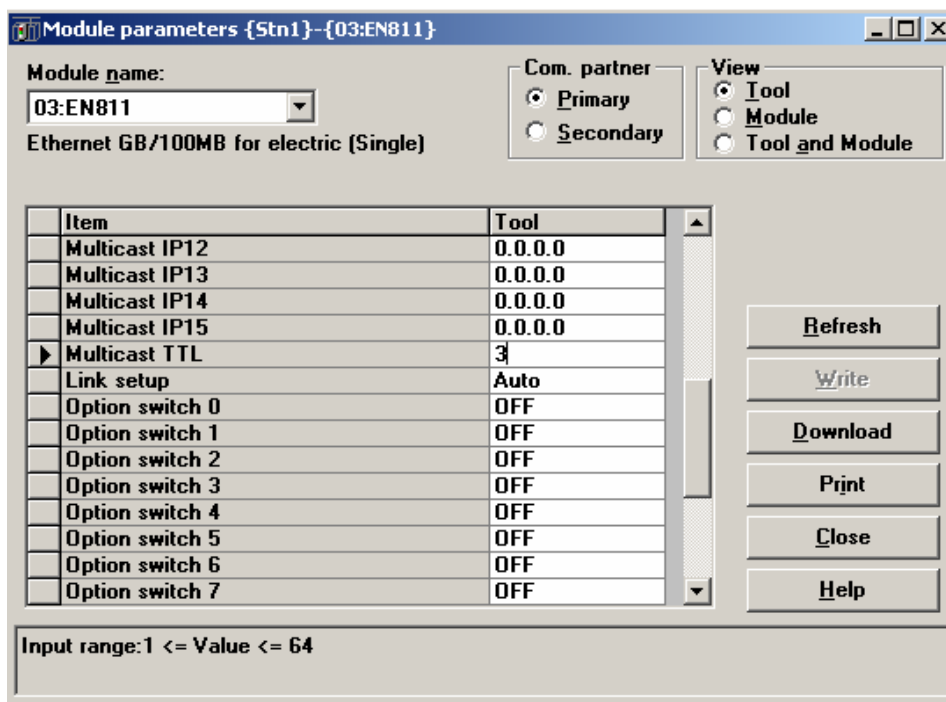

Figure 3-20 An example of multicast routing network setting

3.3.4 Ethernet link speed/duplex setting

In the initial setting state, the link speed/duplex is set to [Auto], and it is set to an appropriate link speed/duplex via auto negotiation. However, if auto negotiation does not work properly between the connected device and EN811 module, this setting item can be used to set a fixed link speed/duplex of the Ethernet. The available combinations are as follows.

- Auto (default)
- 10M half duplex
- 10M full duplex
- 100M half duplex
- 100M full duplex
- Only 1G is Auto.

The following figure shows an example of 100M half duplex setting.

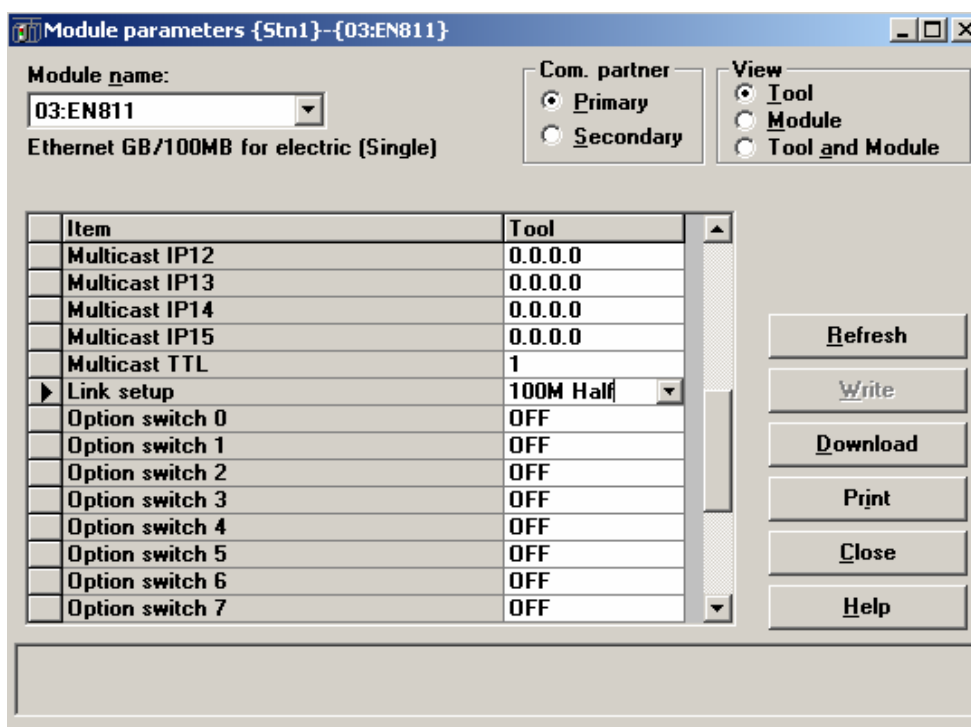

Figure 3-21 An example of multicast routing network setting

3.3.5 Default gateway IP address (router IP address) setting

When the default gateway (router) is used, set the default gateway IP address (router IP address). Only one default gateway IP address can be set.

The following are set to use the default gateway.

- IPF is set to ON with the operation mode switches.
- IP address type is set to [Tool setting].

The default gateway IP address must be set to the identical value of the network address part (including the subnet part) of the IP address of the EN811 module to be registered (172.16.64.** in this example).

The following figure shows an example of system configuration and setting.

(172.16.64.100 in this example)(Subnet mask : 255.255.192.0)

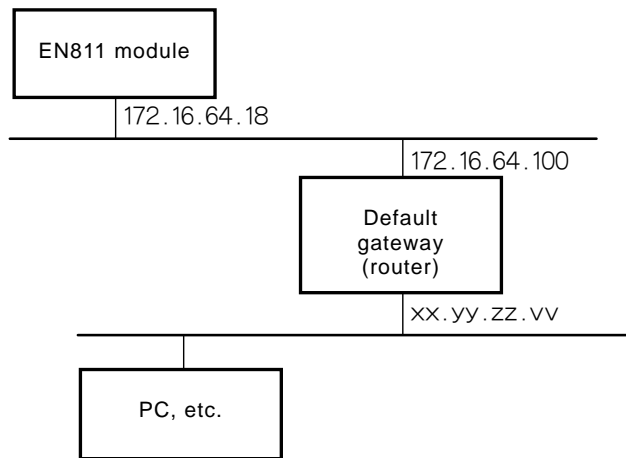

Figure 3-22 System configuration of the default gateway IP address example

The following figure shows an example setting in the engineering tool.

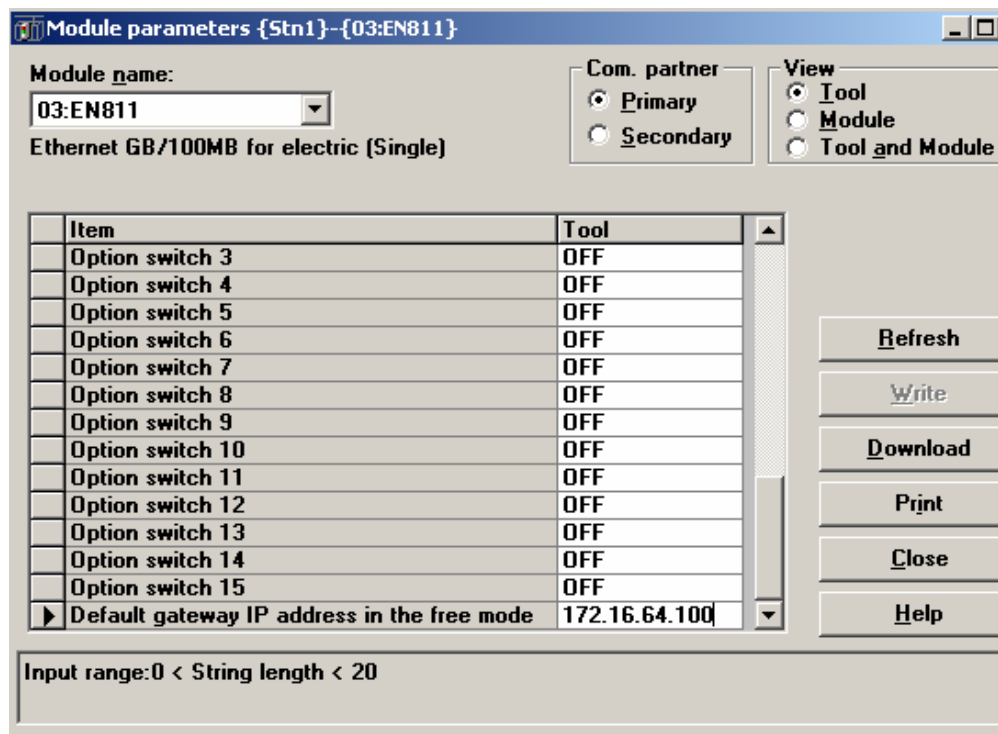

Figure 3-23 An example of default gateway IP address setting

◇ Remark

- Multicast messages will not exceed the default gateway if [Option switch 1] (IGMP processing) is OFF.

3.3.6 Option function

The option functions can be used by setting the option switches. When the option switch is set to ON, the corresponding function operates. The following table lists the settings using the option switches.

Table 3-3 Settings of the option switches

Option switch number	Description	Remark
0	Transmission path diagnosis processing	Refer to "7.2 Transmission path diagnosis information."
1	IGMP processing	Refer to "3.3.3 Multicast routing network setting."
2	Reserved	
3	Reserved	
4	Reserved	
5	Reserved	
6	Reserved	
7	Reserved	
8	Reserved	
9	Reserved	
10	Reserved	
11	Reserved	
12	Reserved	
13	Reserved	
14	Reserved	
15	Reserved	

3.4 Network information

3.4.1 LAN control information

In the system view, select the EN811 module, and select [LAN management information (N)] from [Tool (T)] on the menu bar.

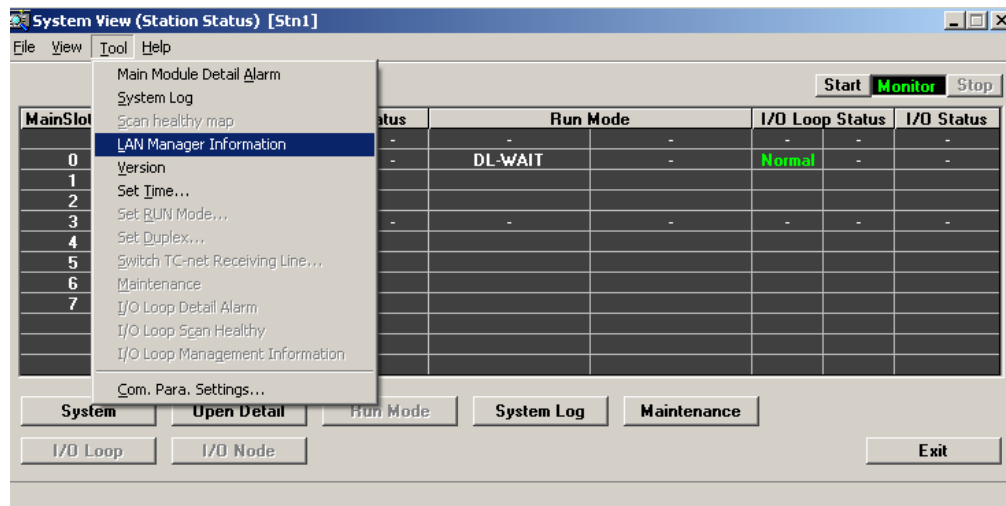

Figure 3-24 System view screen

3.4.2 MIB information

When [MIB information (M)] in the LAN management information screen is clicked, the details of MIB information are displayed.

◇ **Remark**

- MIB: Management Information Base

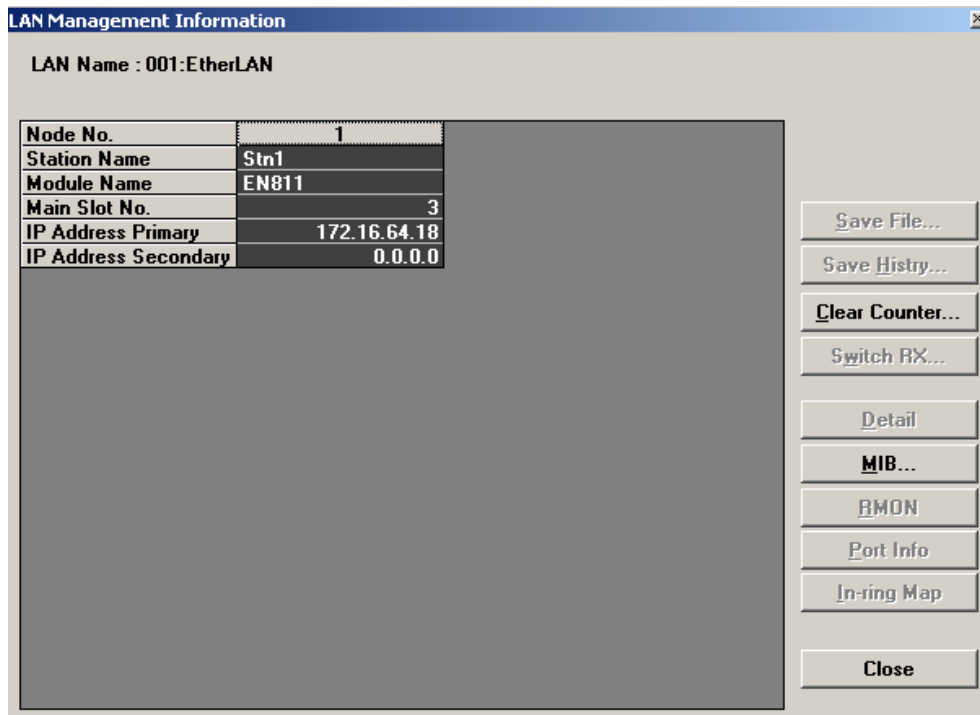

Figure 3-25 LAN management information screen

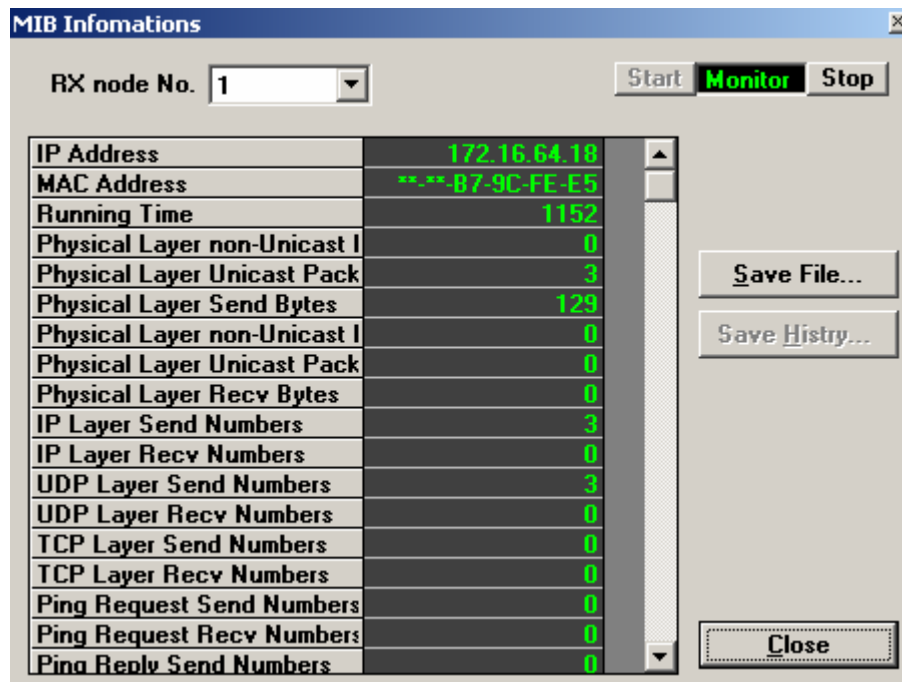



Figure 3-26 MIB information screen



Chapter 4

Operation

This chapter describes the operations of the EN811 module, such as checking before operation, startup, and shutdown.

The switches of the product have been adjusted for the system at the site adjustment. For normal operation, do not change any switch other than the ones the customer is required to operate.

 CAUTION	Avoid incorrect setting. The product does not operate normally if the switches are set incorrectly. Read this operation manual thoroughly to avoid incorrect setting.	 Prohibited
--	--	--

 CAUTION	Stop using immediately when an error occurs. When an error occurs such as unable to turn on the power, stop using and contact one of Toshiba's service representatives.	 Mandatory
--	--	---

4

■ Checking before operation

Before turning on the power and operating the product, check again that the following are as described in this operation manual:

- Switch setting
- Installation
- Wiring

◆ Note

- Checking the switch settings
Use the engineering tool to check the switch settings (station address setting switch and operation mode setting switch).

■ Startup operation

When the power supply module is turned on, the module starts running automatically.

When the EN811 module is up and running, check that it is operating correctly by referring to "Table 1-1 Display on the state display LED and normal display" on page 4.

If the module doesn't start up or if the operation is erroneous, stop using the product immediately and contact one of Toshiba's service representatives.

■ Shutdown operation

To shut down, turn off the power of the power supply module.

Chapter 5

Troubleshooting

This chapter describes troubleshooting for the EN811 module.

If the state display LED of the product displays anything different from the normal display as described in "Table 1-1 Display on the state display LED and normal display" on page 4, or if any error is detected in the human interface station, stop using it immediately and contact one of Toshiba's service representatives.

■ Fault diagnosis method using the LEDs

Perform diagnosis by referring to the following table.

Table 5-1 Diagnosis using the LEDs

State name	LED display				State	Remedy
	RUN	HLTH	ERR	L-A		
Normal operation	ON	ON	OFF	Blinking or ON	Normal	—
Down	OFF	OFF	ON	—	Module error	Replace the module. Contact one of Toshiba's service representatives.

■ Loading the RAS data and system log

To load the RAS data and system log, refer to "Unified Controller nv series / Integrated Controller V Series Engineering Tool 4 Basic Operation Manual (6F8C1290)."

■ When loading fails during serial communication

Load them again. Logs related to serial communication may be traced.

■ When an error occurs

Load the RAS data and system log before removing the module from the basic unit.











Chapter 6

Maintenance and inspection

This chapter describes maintenance and inspection such as daily inspection, periodical inspection, and cleaning.

6.1	Inspection	46
6.1.1	Daily inspection	46
6.1.2	Periodical inspection	47
6.2	Life limited parts	47

 WARNING	<p>For safety, avoid touching the interior of the product. It may cause an electric shock.</p>	 Mandatory
 CAUTION	<p>When touching the product for cleaning, remove the static electricity from your body. The static electricity accumulated in the human body may cause failure of the product.</p>	 Mandatory
 CAUTION	<p>When cleaning the product, do not change the switch setting. Do not exert any stress on the cables. Exerting stress on the cables by touching them may cause malfunction or accidents.</p>	 Prohibited
 CAUTION	<p>Stop using immediately when an error occurs. When an error occurs such as unable to turn on the power, stop using and contact one of Toshiba's service representatives.</p>	 Mandatory

6.1 Inspection

6.1.1 Daily inspection

For daily inspection, check the following.

■ Front panel

<LED>

Check if each of the LEDs is visible. If not, clean it with a soft cloth. Be careful not to change the switch settings. Check the LED state from the front side.

<Ethernet connector>

Check the following:

- Cable connection is normal.
- The modular connector is locked.
- Cable connection is not loose or has an abnormal appearance.

If any abnormality is found, contact one of Toshiba's service representatives.

■ Ventilation hole

Check the front panel and upper ventilation hole of the product for dust or stain. If the ventilation hole is blocked by dust or stain, remove the dust with a vacuum cleaner, and then wipe it with a soft cloth.

■ Indoor environment

Check if the temperature and humidity of the location where the product is located are within the product specification range (Table A-1 in Appendix A).

6.1.2 Periodical inspection

To prevent accidents and use the product safely for long-term operation, it is recommended performing a periodical inspection every 6 months.

Also, it is recommended replacing life limited parts regularly (refer to "6.2 Life limited parts"). For a periodical inspection, consult with one of Toshiba's service representatives.

6.2 Life limited parts

To use the product safely for a long time, replace the life limited parts regularly. When replacing them, consult with one of Toshiba's service representatives.

The following table shows the life limited parts and their replacement cycles.

Table 6-1 Life limited parts and their recommended replacement cycles

Part name	Recommended replacement cycle
Organic semiconductor aluminum solid electrolytic capacitors	15 years
Switches, connectors	A sampling test every 10 years is recommended as preventive maintenance.

6

Chapter 7

Application interface

This chapter describes information by socket, transmission path diagnosis information, EN811 module state information, and usage constraints of the application interface.

7.1	Information by socket	51
7.1.1	Configuration of information by single Ethernet socket	51
7.1.2	Referring to information by socket	52
7.1.3	Timing of generation of information by socket	53
7.2	Transmission path diagnosis information	55
7.2.1	Configuration of transmission path diagnosis information	55
7.2.2	Referring to transmission path diagnosis information	56
7.2.3	Configuration of a transmission path diagnosis frame	57
7.3	EN811 module state information	58
7.4	Usage constraints	59
7.4.1	Port number constraints	59
7.4.2	Frame size constraints	59

The EN811 module expands the state information by socket used by the user application as well as diagnosis information of the transmission path to the EN811 modules within the same network on the station bus. Information by socket includes information by single Ethernet socket.

The configuration of application information on the station bus is as shown below.

Access from the controller

Reserved by the system	
EN state information	(%MW13. CntBase + 130656)
Reserved by the system	
Transmission path diagnosis result	EN_NODEMAPA_* (%MW13. CntBase + 130912)
Reserved by the system	
Single Ethernet information by socket	EN_SOCKET_* (%MW13. CntBase + 130944)
Reserved by the system	

Figure 7-1 Configuration of application information

From the user application of the controller, it is referred to based on the access from the controller. This notation is by word. The value of CntBase varies depending on the slot where the EN811 module is installed. "*" indicates the installation slot number. The value of the installation slot will be described later.

The number of sockets that the user can use is as follows.

EN811: 48



CAUTION

Perform a notification check for transmission data in the application level



Mandatory

7.1 Information by socket

7.1.1 Configuration of information by single Ethernet socket

Figure 7-2 shows the state information by single Ethernet socket.

F	E	D	C	B	A	9	8	0	
TCP	UDP	AOP	POP	CON	RCV	RCL	NOA	reserve	

Figure 7-2 State information by single Ethernet socket

■ Condition that makes each bit "1"

TCP: When single Ethernet socket TCP is used

UDP: When single Ethernet socket UDP is used

AOP: When single Ethernet socket is actively opened (TCP only)

POP: When single Ethernet socket is passively opened (TCP only)

CON: While single Ethernet connection is being established (TCP only)

RCV: Received data exists

RCL: Disconnected by the partner when single Ethernet connection is established (TCP only)

NOA: ACK from the partner is interrupted when single Ethernet connection is established (TCP only)

■ Condition that makes each bit "0"

TCP: Upon close request of the single Ethernet socket

UDP: Upon close request of the single Ethernet socket

AOP: Upon close request of the single Ethernet socket

POP: Upon close request of the single Ethernet socket

CON: Upon close request of the single Ethernet socket

Or when connection is disconnected by the partner.

RCV: No received data

RCL: Upon close request of the single Ethernet socket

NOA: Upon close request of the single Ethernet socket

The following table shows the station bus address where the information by single Ethernet socket is expanded in word addresses.

Table 7-1 Station bus addresses

	Word offset
Socket 0	130944
Socket 1	130945
Socket 2	130946
	•
	•
Socket 46	130990
Socket 47	130991

The base address of the station bus address varies depending on the slot where the EN811 module is installed. The following table shows the starting word addresses of the information by single Ethernet socket when the EN811 module is installed to different slots.

Table 7-2 Slots and station bus addresses

	Base address (CntBase)	Beginning of single Ethernet information by socket	Symbol name on the engineering tool
Slot 0	0	%MW13.130944	EN_SOCKET_0
Slot 1	1048576	%MW13.1179520	EN_SOCKET_1
Slot 2	2097152	%MW13.2228096	EN_SOCKET_2
Slot 3	3145728	%MW13.3276672	EN_SOCKET_3
Slot 4	4194304	%MW13.4325248	EN_SOCKET_4
Slot 5	5242880	%MW13.5373824	EN_SOCKET_5
Slot 6	6291456	%MW13.6422400	EN_SOCKET_6
Slot 7	7340032	%MW13.7470976	EN_SOCKET_7

7.1.2 Referring to information by socket

As described in "7.1.1 Configuration of information by single Ethernet socket," information by socket used by each of the user applications is expanded on the station bus of the EN811 module. There are some considerations when accessing the information.

When socket communication is performed using an instruction word by the controller, the socket number is obtained from the instruction word using the USEND_N command. The socket number is managed by the controller. The socket number is once converted to a socket ID managed by the EN811 module. Based on the converted socket ID, the information by socket is referred to that is expanded on the station bus of the EN811 module.

For detailed explanation of the communication FB, refer to "Unified Controller nv series/Integrated Controller V series Command Manual" (6F8C1226).

7.1.3 Timing of generation of information by socket

The timing of setting and clearing information by socket when opened as TCP/IP and closed after data transmission is shown below.

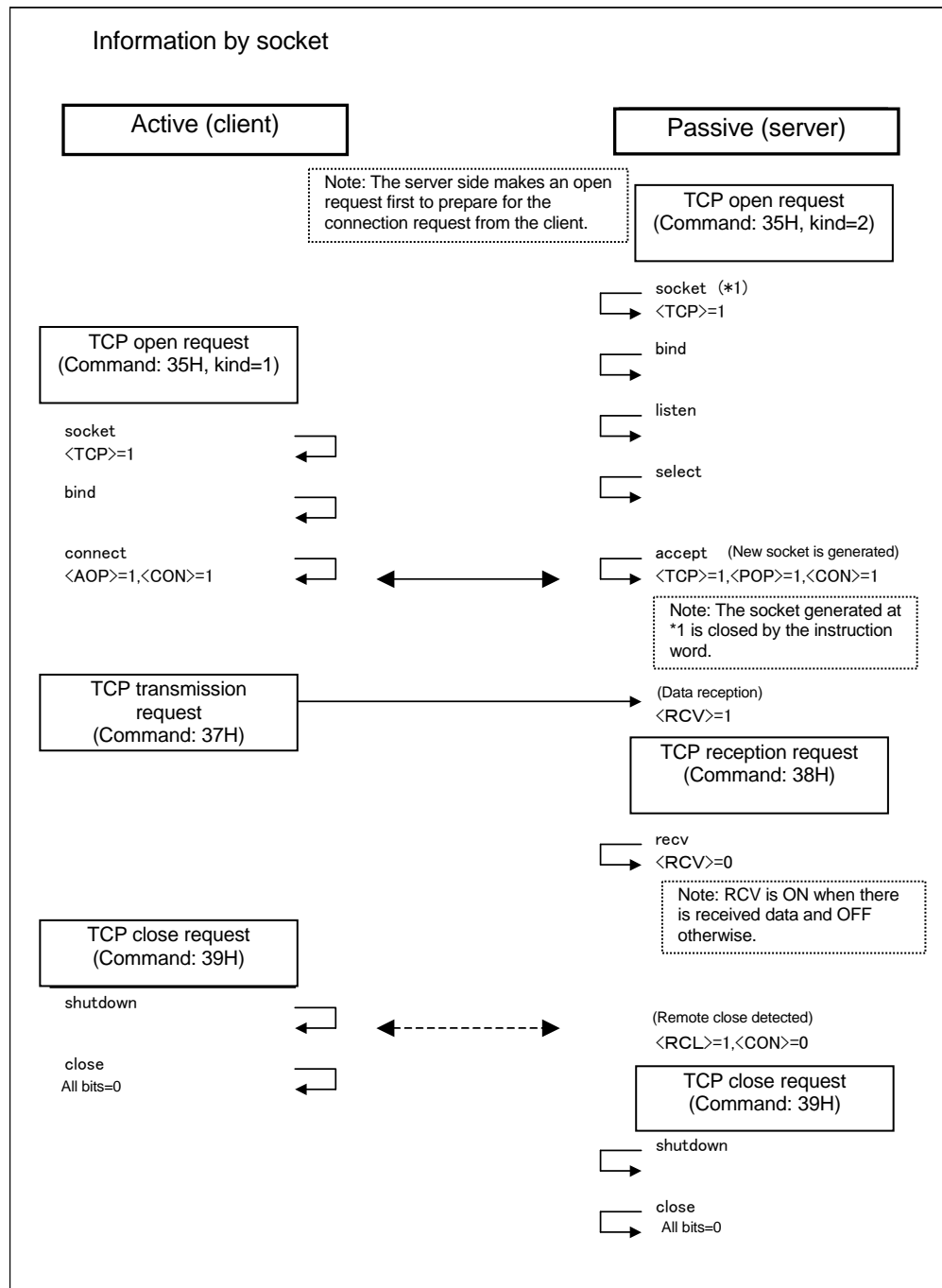

(Note) When running the controller and then halting it, close is requested by the controller basic software for the socket used by the controller.

Figure 7-3 Information by socket and clear timing (1)

The timing of setting and clearing bit information of information by socket is shown below.

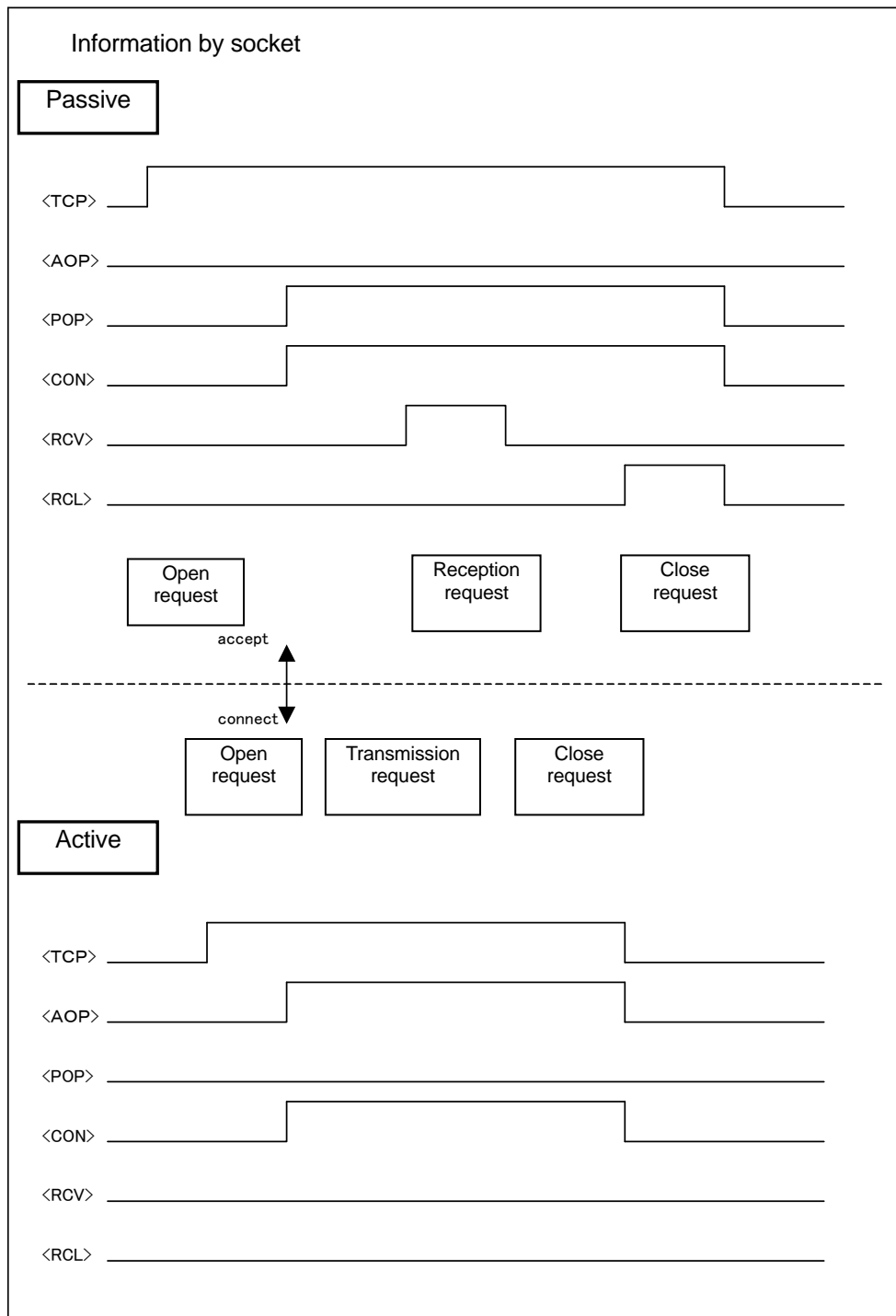

Figure 7-4 Information by socket and clear timing (2)

7.2 Transmission path diagnosis information

The EN811 modules on the same segment mutually monitor the operation states of other units.

In other words, a diagnosis frame is submitted at a fixed cycle (10-second cycle) using the port number 48000. The EN811 modules on the same segment mutually check receptions. When the corresponding node receives it once, the bit of the node becomes "1." Starting from the point in time, if no diagnosis frame is received for 60 seconds continuously, the bit of the node becomes "0."

The information configuration of each node is as shown below. The information of each node is generated based on the station address part of the IP address (e.g. "11" when the IP address is 172.16.64.11), which is valid within the same subnet.

◇ Remark

- It operates when "software option switch 0" is turned on in the engineering tool.

7.2.1 Configuration of transmission path diagnosis information

The transmission path diagnosis information is managed in the following configuration. The relation between the applicable bit and diagnosis frame is as shown below.

Applicable bit "1".....A diagnosis frame has been received within the past 60 seconds.

Applicable bit "0".....No diagnosis frame has been received within the past 60 seconds.

F E D			3			2		0	
ST15	ST14	ST13	. . .			ST3	ST2	ST1	ST0
ST31	ST30	ST29	. . .			ST19	ST18	ST17	ST16
. . .									
ST255	ST254	ST253	. . .			ST243	ST242	ST241	ST240

Figure 7-5 Configuration of transmission path diagnosis information

If the station is in a redundant configuration, diagnosis process is also performed by the EN811 module installed in the ONLINE or STANDBY system to check the

consistency of the transmission path. Even when a changeover of the station between ONLINE and STANDBY occurs, the node diagnosis is continued.

7.2.2 Referring to transmission path diagnosis information

The transmission path diagnosis information implementation address is as follows.

	Word offset
A system information	130912 to 130927

The following table shows the base addresses of the slots and addresses of the installation slots of socket 0 information.

Table 7-3 Slots and addresses

	Base address	Beginning of A system information	Symbol name on the engineering tool
Slot 0	0	%MW13.130912	EN_NODEMAPA_0
Slot 1	1048576	%MW13.1179488	EN_NODEMAPA_1
Slot 2	2097152	%MW13.2228064	EN_NODEMAPA_2
Slot 3	3145728	%MW13.3276640	EN_NODEMAPA_3
Slot 4	4194304	%MW13.4325216	EN_NODEMAPA_4
Slot 5	5242880	%MW13.5373792	EN_NODEMAPA_5
Slot 6	6291456	%MW13.6422368	EN_NODEMAPA_6
Slot 7	7340032	%MW13.7470944	EN_NODEMAPA_7

◇ Remark

- For applications using %MW13, the base address value is different from the Integrated Controller V series. Please be cautious.

7.2.3 Configuration of a transmission path diagnosis frame

A transmission path diagnosis frame sent from the EN811 module has the following content.

Transmission cycle : 10-second cycle

Protocol : UDP

Destination address : Sent as subnet broadcast

Example: 172.16.64xx, Subnet mask : 255.255.192.0

A system : 172.16.127.255

Destination port : 48000

Message size : 1036 bytes

Message format :

Table 7-4 Transmission path diagnosis frame

offset	<31>	<0>	Remarks
00h	Service		0: Single transmission path
04H	InvokeID		(Note 1)
08H	Size		Fixed at 1024
0CH	IP address		(Note 2) A system side IP address (little endian)
10H	Data		(Note 3)
⋮			
408H			

1036 bytes (40CH)

(Note) This format does not include protocol headers such as UDP/IP.

(Note 1) <31> to <16>: Reserved, <15> to <0>: Sequence NO.(0 to 1023)
Set zeroes to <31> to <16> (do not set anything other than 0).

(Note 2) Data from the computer is arbitrary.
From the EN811 module, an IP address is set as little endian.

(Note 3) Data from the computer is arbitrary.
From the EN811 module, information of the installation controller is set.

The EN811 modules mutually send the diagnosis message in 10-second cycles for diagnosis.

Computers can also be diagnosed by sending the message via an application. Observe the transmission cycle of 10 seconds. If the cycle is too short, network traffic will increase. If the cycle is too long, the result of the diagnosis will be "no diagnosis frame received."

In the diagnosis of each transmission path, it is diagnosed as normal when there is received data from each system. Therefore, the presence of the received data

determines whether the transmission path is diagnosed as normal or abnormal. When sending a diagnosis frame, observe the format as described above.

7.3 EN811 module state information

The transmission request counter (from the controller to EN811 module), transmission packet counter (within the EN811 module), and transmission buffer-related counter are expanded on the station bus as RAS information. The expansion cycle is 10 seconds.

Table 7-5 Module state information

Offset (byte)	Description
+00H	Unicast transmission request counter from the host (station bus driver task level)
+04H	Multicast transmission request counter from the host (station bus driver task level)
+08H	Broadcast transmission request counter from the host (station bus driver task level)
+0CH	Unicast transmission request counter from the host (communication processing task level)
+10H	Multicast transmission request counter from the host (communication processing task level)
+14H	Broadcast transmission request counter from the host (communication processing task level)
+18H	Transmission request normal for the Ethernet controller (Ethernet driver level)
+1CH	Transmission request abnormal for the Ethernet controller (Ethernet driver level)
+20H	Number of unicast packets received (IP level)
+24H	Number of multicast packets received (IP level)
+28H	Number of broadcast packets received (IP level)
+2CH	Number of discarded packets (IP level)
+30H	Acquisition of the Ethernet buffer succeeded
+34H	Acquisition of the Ethernet buffer failed
+38H	Number of remaining Ethernet buffers

7.4 Usage constraints

7.4.1 Port number constraints

The EN811 module reserves the following ports.

Port number 10000: PCMP

Port number 48000: Transmission path diagnosis

Use port numbers from 1024 to 65535 other than above.

7.4.2 Frame size constraints

The EN811 module does not support jumbo frames. Do not use them in the connected devices such as PCs.

7

Appendix A

Specifications

A.1	General specifications	62
A.2	Ethernet transmission specifications.....	63
A.3	Function specifications.....	63
A.4	Serial communication port (RS-232C) transmission specifications	64

A.1 General specifications

Table A-1 General specifications

Item	Specification
	EN811
Operating temperature range (product ambient temperature)	0 to 55°C
Operating humidity range	10 to 95%RH (no condensation)
Storage temperature range	−40 to 70°C
Storage humidity range	5 to 95%RH (no condensation)
Power voltage range	4.75 to 5.25VDC (Rating: 5.0VDC)
Current consumption (when rated power is fed)	2A or less (5.0VDC)
Power consumption (when rated power is fed)	10W or less
Dust	0.3mg/m ³ or less (no conductive dust)
Vibration resistance	5≤f<9: half amplitude 3.5mm 9≤f<150: constant acceleration 9.8m/sec ²
Shock resistance	147m/S ² (3-axis directions)
Grounding	Type D grounding (grounding resistance of 100Ω or less)
Cooling	Natural air cooling or forced air cooling
Module dimensions	262(H)×20(W)×207(D)mm
Weight	500g or less
Communication interface	1000BASE-T, 100BASE-TX, 10BASE-T (switched automatically) Transmission path single

A.2 Ethernet transmission specifications

Table A-2 Ethernet transmission specifications

Item	Specification
Applicable standard	IEEE 802.3ab • 1000BASE-T
Media access method	CSMA/CD method
Data transmission speed	10Mbps/100Mbps/1Gbps
Ethernet frame	DIX type
Topology	Star shape
Transmission path	Single bus
Transmission cable/cable length	Category 6/Category 5e Twisted pair cable: Max. 100m
Node count	Max. 254 nodes/system (single bus) (Note)
Maximum number of EN811 module implemented	Max. 4 units/1 basic unit (multi-port)
Interface	RJ-45 connector

(Note) According to the specifications of the applicable system.

A

A.3 Function specifications

Table A-3 Function specifications

Item	Specification						
Protocol	TCP/UDP/IP, PCMP(Note)						
Transmission method	<ul style="list-style-type: none"> Point-to-point transmission Multicast transmission Broadcast transmission 						
Monitoring function (RAS)	Hardware/software						
System configuration	<ul style="list-style-type: none"> Multi-port Max. number of Ethernet modules: 4 						
Port used by the EN811 module	<table border="0"> <tr> <td>PCMP</td> <td>Port number</td> <td>10000</td> </tr> <tr> <td>Node diagnosis</td> <td>Port number</td> <td>48000</td> </tr> </table>	PCMP	Port number	10000	Node diagnosis	Port number	48000
PCMP	Port number	10000					
Node diagnosis	Port number	48000					

(Note 1) PCMP is Toshiba's protocol.

(Note 2) Check the transmission of the transmission data at the application level.

A.4 Serial communication port (RS-232C) transmission specifications

Table A-4 Serial specifications

Item	Specification
Data transmission speed	Max. 9600bps
Synchronization method	Asynchronous
Transmission cable	Cross cable with 9-pin-9-pin D-sub connector
Cable length	Max. 15m
Communication method	Full duplex
Communication setting	<ul style="list-style-type: none">Parity bit: NoneCharacter length: 8 bitsStop bit: 1 bit

Appendix B

Outside dimensions

B

The following figure shows the outside dimensions of the EN811.

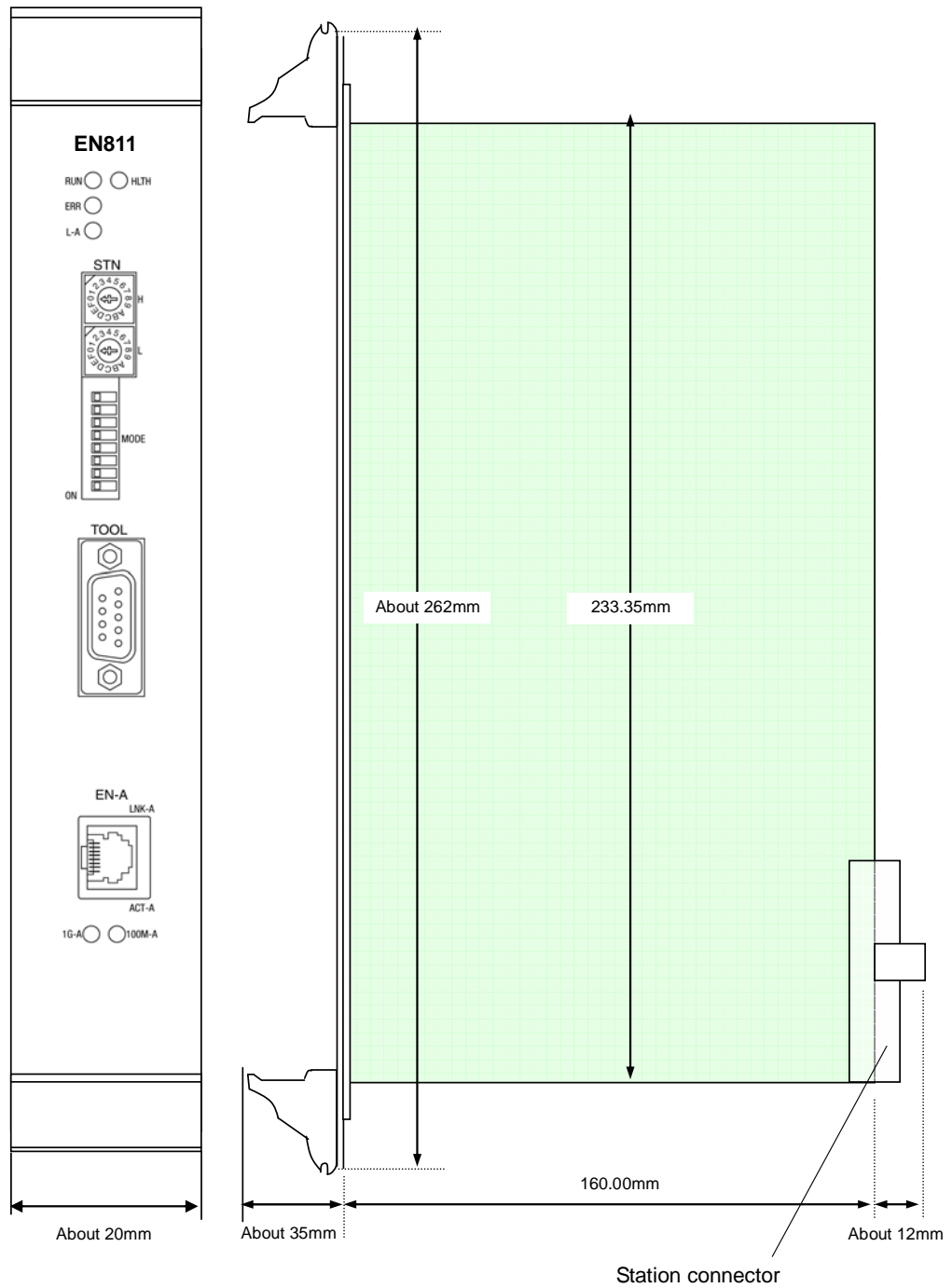

Figure B-1 EN811 outside dimensions

B

Appendix C

Related products

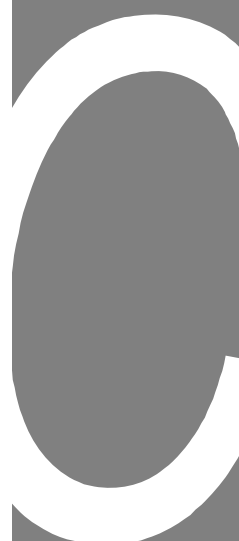

Table C-1 Related products

Product name	Rating	Remark
RS-232C cable	9-pin D-sub	Standard length 5m

Appendix D

Decimal-hexadecimal conversion table

Table D-1 Decimal-hexadecimal conversion table

Decimal	Hexadecimal	Decimal	Hexadecimal	Decimal	Hexadecimal	Decimal	Hexadecimal
0	0	32	20	64	40	96	60
1	1	33	21	65	41	97	61
2	2	34	22	66	42	98	62
3	3	35	23	67	43	99	63
4	4	36	24	68	44	100	64
5	5	37	25	69	45	101	65
6	6	38	26	70	46	102	66
7	7	39	27	71	47	103	67
8	8	40	28	72	48	104	68
9	9	41	29	73	49	105	69
10	A	42	2A	74	4A	106	6A
11	B	43	2B	75	4B	107	6B
12	C	44	2C	76	4C	108	6C
13	D	45	2D	77	4D	109	6D
14	E	46	2E	78	4E	110	6E
15	F	47	2F	79	4F	111	6F
16	10	48	30	80	50	112	70
17	11	49	31	81	51	113	71
18	12	50	32	82	52	114	72
19	13	51	33	83	53	115	73
20	14	52	34	84	54	116	74
21	15	53	35	85	55	117	75
22	16	54	36	86	56	118	76
23	17	55	37	87	57	119	77
24	18	56	38	88	58	120	78
25	19	57	39	89	59	121	79
26	1A	58	3A	90	5A	122	7A
27	1B	59	3B	91	5B	123	7B
28	1C	60	3C	92	5C	124	7C
29	1D	61	3D	93	5D	125	7D
30	1E	62	3E	94	5E	126	7E
31	1F	63	3F	95	5F	127	7F

Table D-1 Decimal-hexadecimal conversion table

Decimal	Hexadecimal	Decimal	Hexadecimal	Decimal	Hexadecimal	Decimal	Hexadecimal
128	80	160	A0	192	C0	224	E0
129	81	161	A1	193	C1	225	E1
130	82	162	A2	194	C2	226	E2
131	83	163	A3	195	C3	227	E3
132	84	164	A4	196	C4	228	E4
133	85	165	A5	197	C5	229	E5
134	86	166	A6	198	C6	230	E6
135	87	167	A7	199	C7	231	E7
136	88	168	A8	200	C8	232	E8
137	89	169	A9	201	C9	233	E9
138	8A	170	AA	202	CA	234	EA
139	8B	171	AB	203	CB	235	EB
140	8C	172	AC	204	CC	236	EC
141	8D	173	AD	205	CD	237	ED
142	8E	174	AE	206	CE	238	EE
143	8F	175	AF	207	CF	239	EF
144	90	176	B0	208	D0	240	F0
145	91	177	B1	209	D1	241	F1
146	92	178	B2	210	D2	242	F2
147	93	179	B3	211	D3	243	F3
148	94	180	B4	212	D4	244	F4
149	95	181	B5	213	D5	245	F5
150	96	182	B6	214	D6	246	F6
151	97	183	B7	215	D7	247	F7
152	98	184	B8	216	D8	248	F8
153	99	185	B9	217	D9	249	F9
154	9A	186	BA	218	DA	250	FA
155	9B	187	BB	219	DB	251	FB
156	9C	188	BC	220	DC	252	FC
157	9D	189	BD	221	DD	253	FD
158	9E	190	BE	222	DE	254	FE
159	9F	191	BF	223	DF	255	FF



D

Appendix E

Sample programs

Some examples of simple message transmission programs are provided below for your reference.

These programs are implemented by using USEND_N and URCV_N of the communication FB.

For detailed explanation of the communication FB, refer to "Unified Controller nv series/Integrated Controller V series Command Manual" (6E8C4826).

■ An example of UDP transmission

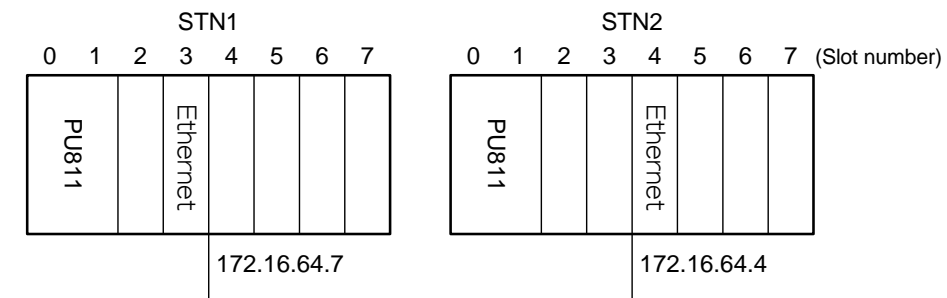

Figure E-1 An example of UDP transmission

In the reference program, transmission is done from the PU811 of STN1 using the Ethernet UDP port 20014 of STN1 to PU811 of STN2 for the Ethernet UDP port 20013 of STN2. In STN2, the data is received from the UDP port 20013.

• Variation definition (UDP transmission)

```

VAR
  OPEN_COMPLETE:      BOOL;
  OPEN_ERROR:         BOOL;
  OPEN_REQ:           BOOL;
  TX_COMPLETE:        BOOL;
  TX_ERROR:           BOOL;
  TX_REQ:             BOOL;
  OPEN_STATUS1:       INT;
  USEND_N_1:          USEND_N;
  USEND_N_2:          USEND_N;
  SEND_STATUS:        INT;
  US_DUMMY1:          WORD;
  US_DUMMY2:          UINT;
  US_SIZE:            UNIT;
  US_DATA: ARRAY[0..511] OF WORD;
  U_O:                typeUDP_OPEN;
  U_S:                typeUDP_SEND_BC;
  U_C:                typeUDP_CLOSE;
  CLOSE_REQ:         BOOL;
END_VAR

```

Program (UDP transmission)

/* UDP OPEN REQUEST */

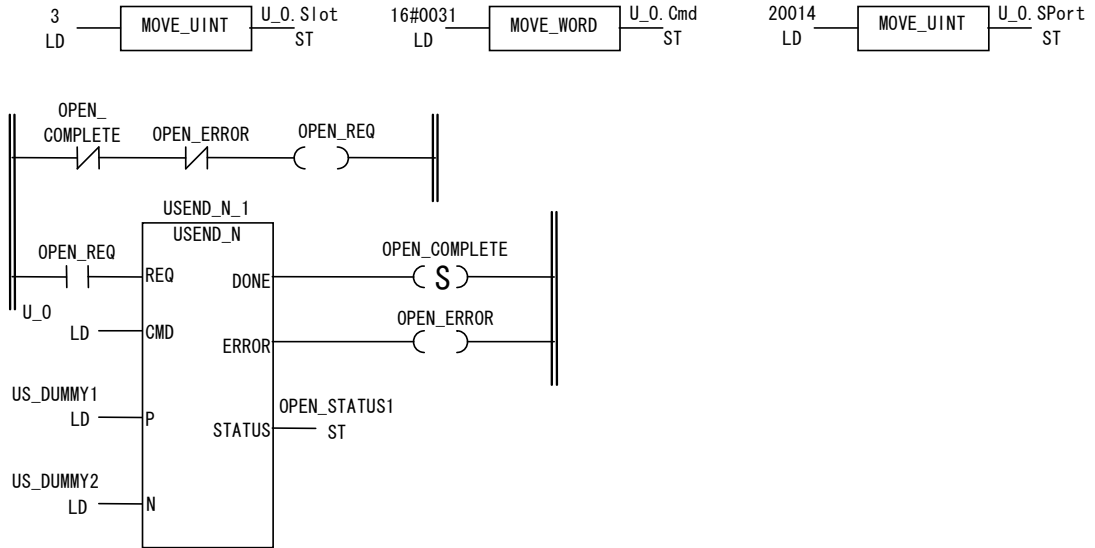

/* UDP SEND REQUEST */

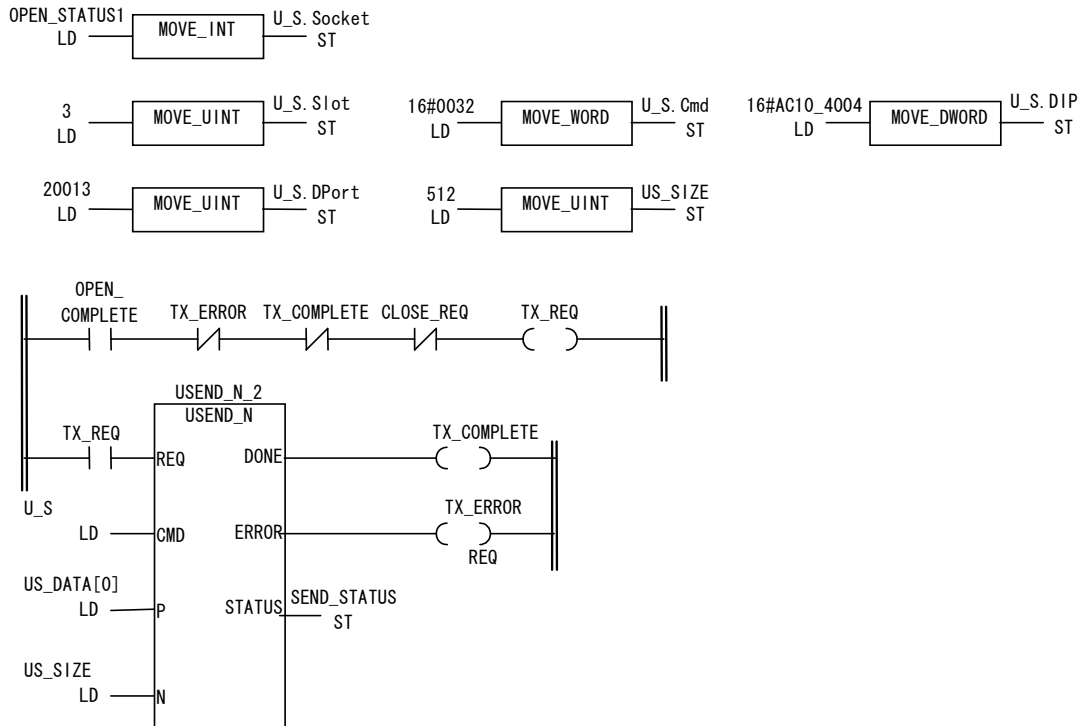

E

- Variation definition (UDP reception)

VAR

```
OPEN_COMPLETE:      BOOL;
OPEN_ERROR:         BOOL;
OPEN_REQ:           BOOL;
RX_COMPLETE:        BOOL;
RX_ERROR:           BOOL;
RX_REQ:             BOOL;
CLOSE_COMPLETE:     BOOL;
CLOSE_ERROR:        BOOL;
CLOSE_REQ:          BOOL;
RCV_STATUS:         INT;
CLOSE_STATUS1:      INT;
UR_DUMMY1:          WORD;
UR_DUMMY2:          UINT;
UR_SIZE:            UNIT;
UR_DATA: ARRAY[0..512] OF WORD;
URCV_N_1:           URCV_N;
USEND_N_1:          USEND_N;
OPEN_STATUS1:       INT;
U_O:                typeUDP_OPEN;
U_R:                typeUDP_RCV_BC;
U_C:                typeUDP_CLOSE;
T_SK_CMD:           typeTCP_SEND;
T_SOCKET:           URCV_N;
T_SK_REQ:           BOOL;
T_SK_COMP:          BOOL;
T_SK_ERR:           BOOL;
T_SK:               INT;
T_SK_SOCKET:        INT;
T_SK_DT:            WORD;
RX_TRG:             BOOL;
END_VAR
```

Program (UDP reception)

/* UDP OPEN REQUEST */

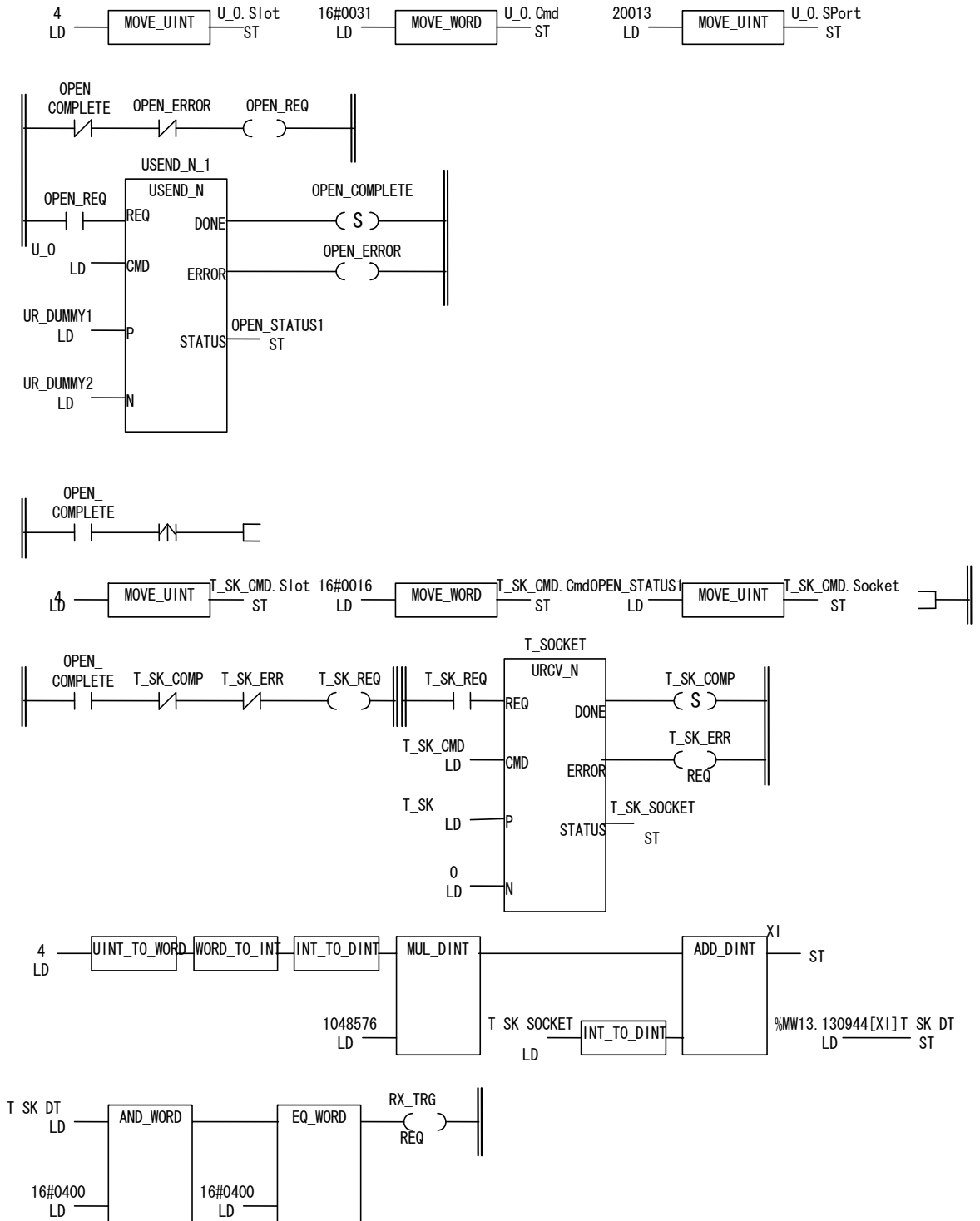

E

/*UDP RECEIVE REQUEST */

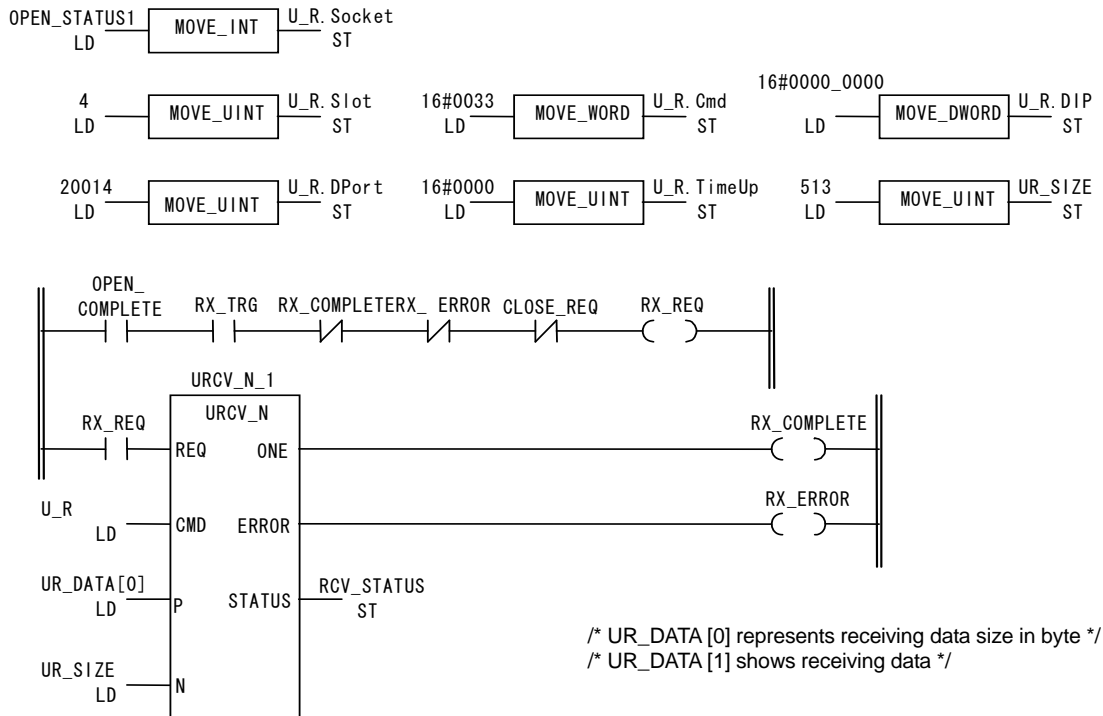

■ Close request (closing when CLOSE_REQ is ON)(for UDP)

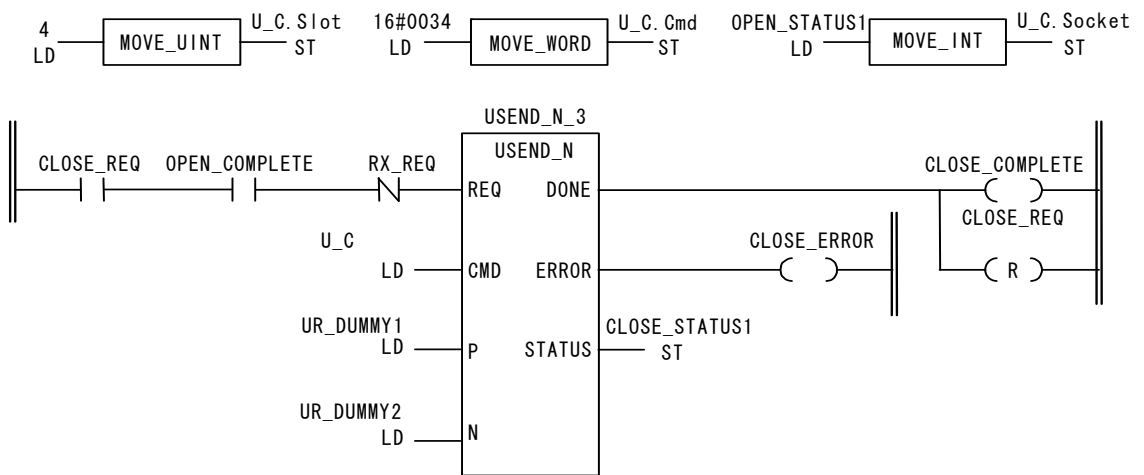

■ An example of TCP transmission

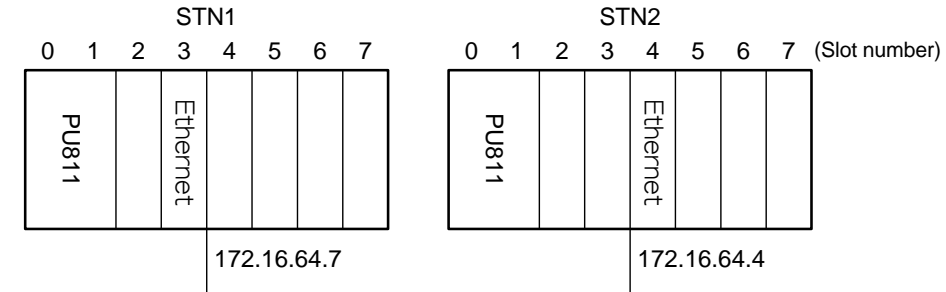

Figure E-2 An example of TCP transmission

In the reference program, transmission is done from the PU811 of STN1 using the Ethernet TCP port 30004 of STN1 to PU811 of STN2 for the Ethernet TCP port 30003 of STN2. In STN2, the data is received from the TCP port 30003.

- Variation definition (TCP transmission)

VAR

```

OPEN_COMPLETE:      BOOL;
OPEN_ERROR:         BOOL;
OPEN_REQ:           BOOL;
TX_COMPLETE:        BOOL;
TX_ERROR:           BOOL;
TX_REQ:             BOOL;
OPEN_STATUS1:       INT;
TS_DUMMY:           WORD;
USEND_N_1:          USEND_N;
USEND_N_2:          USEND_N;
SEND_STATUS:        INT;
CLOSE_REQ:          BOOL;
TS_DATA: ARRAY[0..511] OF WORD;
T_O:                typeTCP_OPEN;
T_S:                typeTCP_SEND;
END_VAR

```

Program (TCP transmission)

/* TCP OPEN REQUEST (ACTIVE)*/

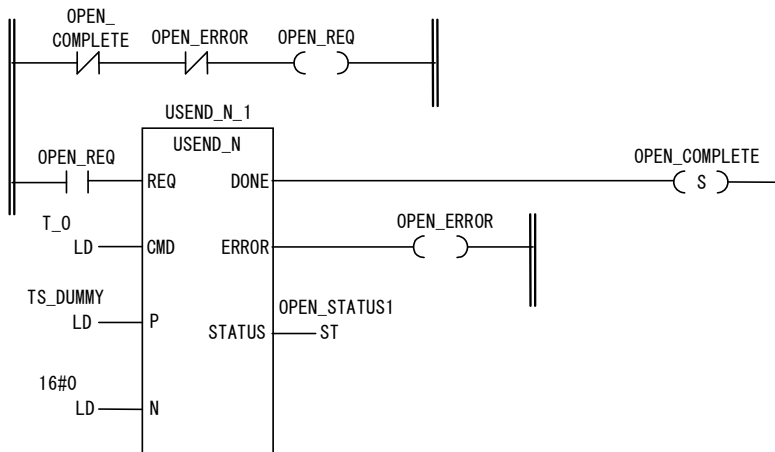
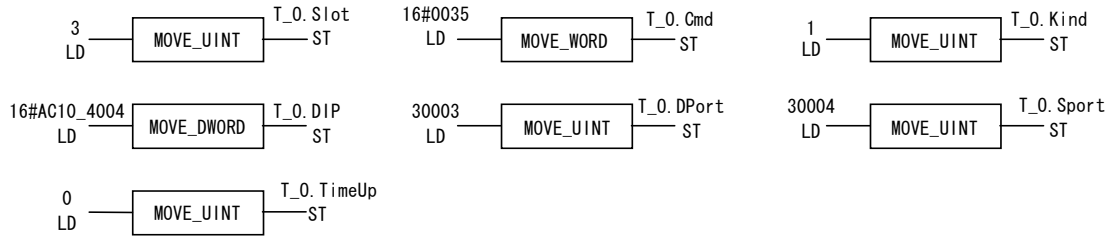

/* TCP SEND REQUEST */

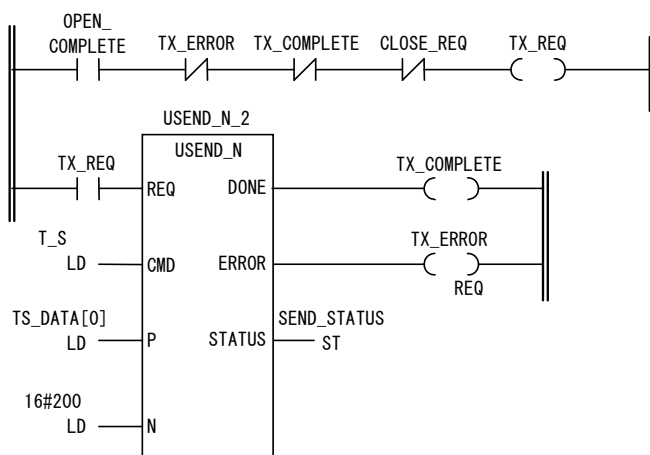
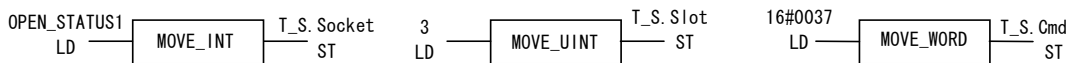

■ Variable definition (TCP reception)

```
VAR
  OPEN_COMPLETE:          BOOL;
  OPEN_ERROR:             BOOL;
  OPEN_REQ:               BOOL;
  RX_COMPLETE:            BOOL;
  RX_ERROR:               BOOL;
  RX_REQ:                 BOOL;
  CLOSE_COMPLETE:        BOOL;
  CLOSE_ERROR:            BOOL;
  CLOSE_REQ:              BOOL;
  RCV_STATUS:             INT;
  CLOSE_STATUS1:          INT;
  TR_DATA: ARRAY[0..512] OF WORD;
  T_O:                    typeTCP_OPEN;
  T_R:                    typeTCP_RCV;
  T_C:                    typeTCP_CLOSE;
  URCV_N_1:               URCV_N;
  USEND_N_1:              USEND_N;
  USEND_N_3:              USEND_N;
  OPEN_STATUS1:           INT;
  TR_DUMMY:               WORD;
  T_SK_CMD:               typeTCP_SEND;
  T_SOCKET:               URCV_N;
  T_SK_REQ:               BOOL;
  T_SK_COMP:              BOOL;
  T_SK_ERR:               BOOL;
  T_SK:                   INT;
  T_SK_SOCKET:            INT;
  T_SK_DT:                WORD;
  RX_TRG:                 BOOL;
END_VAR
```

Program (TCP reception)

/*TCP OPEN REQUEST (PASSIVE)*/

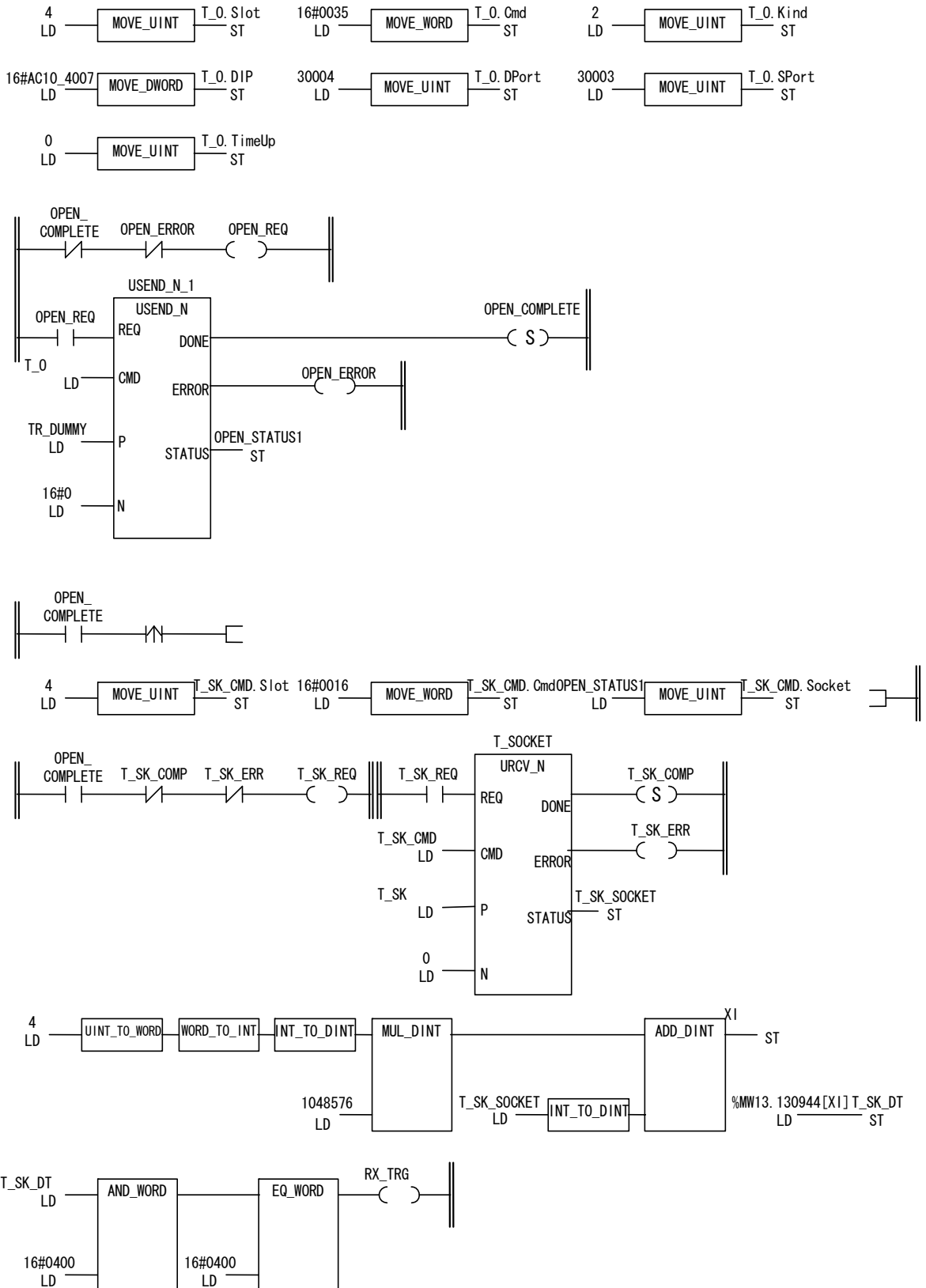

/* TCP RECEIVE REQUEST */

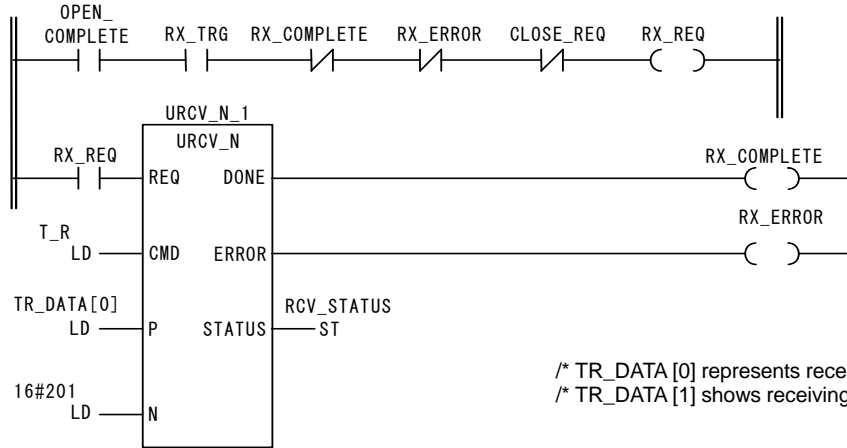

/* TR_DATA [0] represents receiving data size in byte */
 /* TR_DATA [1] shows receiving data */

Close request (closing when CLOSE_REQ is ON)(for TCP)

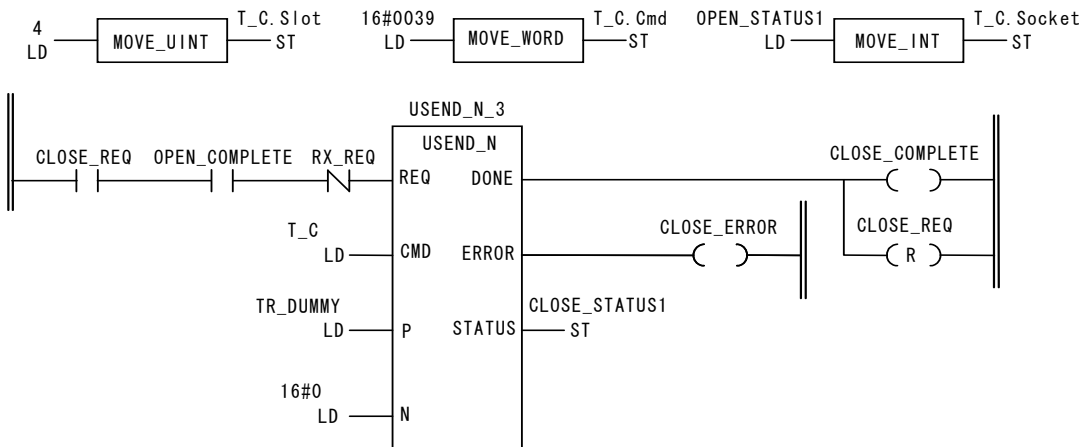

E

Appendix F

Return code list

The return codes related to EN811 are shown below.

The return codes are outputted via the communication FB. For detailed explanation of the communication FB, refer to "Toshiba Integrated Controller V series/Unified Controller nv series Instruction Word Manual (LD/FBD/SFC/ST)(6F8C1226)."

The following table shows the error codes that occur in the USND_N/URCV_N command request.

Table F-1 USND_N/URCV_N command error code list

Return value	Description
-5000	Communication command request count exceeded
-5001	Command type error
-5002	Reception timeout
-5003	Socket in use or not open
-5004	Slot/socket number out of range
-5005	Socket not open
-5006	Port number overlap
-5007	Target busy or disconnected
-5099	Other error
-1001	Applicable socket busy
-1002	Applicable socket not generated
-1005	Ping timeout
-1006	Ping busy
-1010	Socket type error
-1101	Insufficient reception memory block
-2001	Communication request count exceeded
-2002	Request buffer count exceeded
-2005	Applicable socket not started
-2006	Number of used ports exceeded
-2007	Response timeout
-2008	Unable to reserve buffer resource
-2009	Resetting EN board
-2201	Interrupt acceptance wait timeout
-2202	Confirmation/instruction response wait timeout

The following table shows the error codes that occur during communication procedures.

Table F-2 Communication procedure error code list

Communication procedure	Return value	Description
■ACCEPT		
ENOBUFS	-15	Insufficient resource
EBADF	-16	Not a valid socket identifier
EWOULDBLOCK	-18	Socket is set to asymmetric I/O mode, and nothing is waiting for connection
EOPNOTSUPP	-56	The specified socket is not SOCK_STREAM type
EPROTO	-71	Protocol error
■EN_BIND		
EBADF	-16	Not a valid socket identifier
EFAULT	-17	The argument (addr or addrlen) is not in the valid range of the user's address space
EAFNOSUPPORT	-58	The specified address family is currently not supported
EADDRINUSE	-59	The provided address has been used
EADDRNOTAVAIL	-60	The provided address cannot be used by this system
■CLOSE		
EBADF	-16	Not a valid socket identifier
■CONNECT		
EHOSTUNREACH	-11	IP address of the target is invalid
ETIMEDOUT	-12	Timeout. Connection does not complete after a certain period of time
EBADF	-16	Not a valid socket identifier
EINVAL	-22	Already bound
EDESTADDRREQ	-50	The argument (name,namelen) is invalid
EAFNOSUPPORT	-58	The specified address family is currently not supported
EADDRNOTAVAIL	-60	The provided address cannot be used by this system
EISCONN	-67	The socket has already been connected
■LISTEN		
EBADF	-16	Not a valid socket identifier
EINVAL	-22	Invalid parameter
EOPNOTSUPP	-56	The socket type does not support listen
■RECV		
■RECVFROM		
ETIMEDOUT	-12	Timeout
ECONNABORTED	-14	Connection was disconnected on the local system
EBADF	-16	Not a valid socket identifier
EFAULT	-17	Argument (buffer pointer) pointer is invalid
EWOULDBLOCK	-18	No data to receive
EPIPE	-32	The connection has been disconnected
EOPNOTSUPP	-56	The specified operation is not supported by the socket
■SELECT		
EBADF	-16	Any of the socket identifiers specified by the bit mask is invalid

Table F-2 Communication procedure error code list (continued)

Communication procedure	Return value	Description
■ SEND		
■ SENDTO		
EHOSTUNREACH	-11	Unable to send to the specified destination
ECONNABORTED	-14	Connection was disconnected on the local system
ENOBUFS	-15	Insufficient resource
EBADF	-16	Not a valid socket identifier
EFAULT	-17	Argument (buffer pointer) is invalid
EWOULDBLOCK	-18	Unable to accept the transmission request
EMSGSIZE	-19	Invalid message size
EPIPE	-32	A request was made to the disconnected socket
EDSTADDRREQ	-50	Invalid specification of the destination address
EAFNOSUPPORT	-58	The specified address family cannot be used for the socket
ESHUTDOWN	-69	Shutdown has been issued
■ SHUTDOWN		
ENOBUFS	-15	Insufficient resource
EBADF	-16	Not a valid socket identifier
EPIPE	-32	Transmission was attempted to a disconnected socket
■ SOCKET		
ENOBUFS	-15	Unable to generate a socket due to no buffer area
EPROTONOSUPPORT	-54	The specified protocol is not supported
ESOCKETNOSUPPORT	-55	The specified socket type is not supported by the address family
EAFNOSUPPORT	-58	The specified address family is not supported by the current version of the system

Unified Controller nv Series Ethernet (EN811) Module Instruction Manual

July 23, 2008

First Edition

TOSHIBA CORPORATION

Transmission Distribution & Industrial Systems Company
Microelectronics & System Components Department System Components Support Group
1, Toshiba-Cho, Fuchu-Shi, Tokyo, 183-8513, Japan Tel +81-42-333-2206

© Toshiba Corporation 2008
All Right Reserved.

No part of this document may be reproduced
without the prior written consent of Toshiba.

© **TOSHIBA CORPORATION** 2008
All Rights Reserved.

1, Toshiba-Cho, Fuchu-Shi, Tokyo, 183-8513, Japan

1358.1.0807